

THE DEVELOPMENT OF THE NARROW GAP MULTI-PASS WELDING SYSTEM USING LASER VISION SYSTEM

By Hee-Chang Park¹, Young-Jo Park¹, Keun-Ho Song², Jae-Woong Lee²
Yung-Hwa Jung³ and Luc Didier⁴

¹Korea Institute of Machinery and Materials
171, Jang-dong, Youseong-ku, Daejeon, Korea, hcpark@mailgw.kimm.re.kr

²Doosan Heavy Industries & Construction Co.LTD.
555, Guygok-dong, Changwon, Kyungnam, Korea

³Jonghap Machinery Co. Ltd.
85, Yusan-dong, Yangsan, Kyungnam, Korea

⁴Servo Robot Inc.
1370 Rue Hocquart, Saint-Bruno, Quebec, Canada

ABSTRACT

In the multi-pass welding of pressure vessels or ships, the mechanical touch sensor system is generally used together with a manipulator to measure the gap and depth of the narrow gap to perform seam tracking. Unfortunately, such mechanical touch sensors may commit measuring errors caused by the deterioration of the measuring device.

An automation system of narrow gap multi-pass welding using a laser vision system which can track the seam line of narrow gap and which can control welding power has been developed. The joint profile of the narrow gap, with 250mm depth and 28mm width, can be captured by laser vision camera. The image is then processed for defining tracking positions of the torch during welding. Then, the real-time correction of lateral and vertical position of the torch can be done by the laser vision system. The adaptive control of welding conditions like welding currents and welding speeds, can also be performed by the laser vision system, which cannot be done by conventional mechanical touch systems. The developed automation system will be adopted to reduce the idle time of welders, which happens frequently in conventional long welding processes, and to improve the reliability of the weld quality as well.

KEYWORDS

Laser vision sensor, narrow gap, SAW, seam tracking, multi-pass welding, adaptive control

1. Introduction

In factories, the automation of welding processes which generally corresponds to 3-D work is very important. But until now, the automation of welding processes almost exclusively focused on the automation of transfer machines for welding work pieces. The automation of the functions corresponding to welders' skill, such as capture of welding joint profiles, observation of weld pools, or control of welding power supplies, was known to be very difficult technologically.

For the realization of the above-mentioned processes, expert systems are required and should be integrated, for example, the vision sensor which corresponds to welder's eyes, the image-processing technology for capturing joint profiles, the expert software for observing and evaluating welding quality, the data base for adaptive control of welding power and the welding jig, which corresponds to the welder's hands. It has been very difficult to develop a versatile welding automation system which can accommodate all these conditions, even for different kinds of welding processes, and to execute such intelligent functions well[1].

The multi-pass welding for plates over 50mm thickness is widely used in heavy industries including ship building yards. Multi-pass welding is said to be very low in productivity because the process time is generally long and the operator must monitor every welding process to maintain certain welding quality.

Nowadays in heavy industries, the welding groove has been changed from V-shape to narrow gap which has only 18~24mm gap to reduce the both the number of welding passes and process time. For example, for welding 250mm thickness plate, there should be 90 welding passes in a V-shape groove joint, but only 40 passes is enough in a narrow gap joint. Figure 1 shows these two groove joints and the welding passes.

Through an international joint project between KIMM, Jonghap Machinery Co. and Servo-Robot of Canada, the automatic narrow gap SAW multi-pass welding system, which uses laser vision system and has some intelligent functions, has been developed and a proto type of the system has been made to test the adaptability to welding in the field[2].

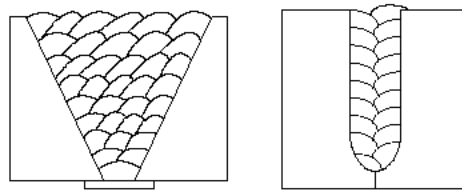

Figure 1. Weld passes of V-shape and narrow gap joint

2. Automation of the Narrow Gap SAW

A prototype of narrow gap SAW multi-pass welding system has been designed, as shown in Figure 2. The manipulator has a three-axis servo system, X-axis is boom slide (stroke 2000mm) and Y and Z-axis are cross slides (stroke 200mm×400mm). In long seam welding, the X-axis is servo controlled, but in girth seam welding, the turning roller and speed controller is required instead of the X-axis. These three AC servo motor systems are position controlled by a laser vision system via an axis control board for tracking the seam line. The feedback encoder signals from the servo motors come into the AC servo driver and the axis control board at the same time, and AC servo drivers are set to the speed control mode as shown in Figure 3.

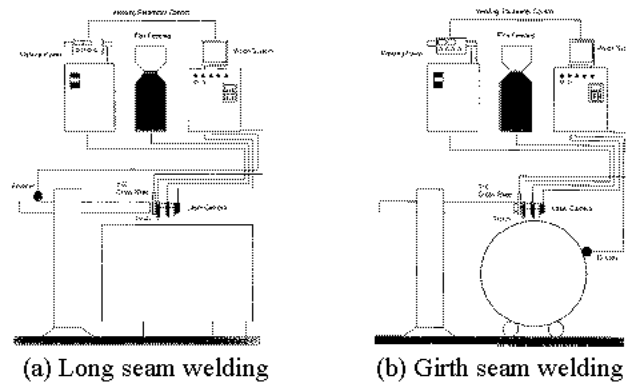

Figure 2. SAW multi-pass welding system

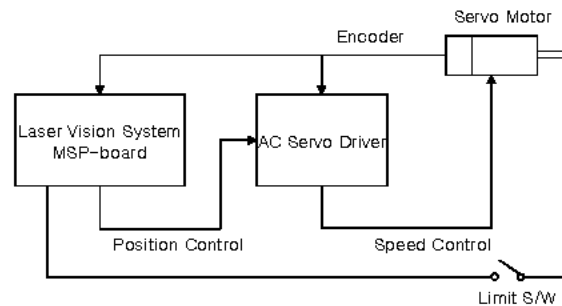

Figure 3. AC servo motor control system

First of all, a torch head for narrow gap has been designed and manufactured. For the automation of welding sequences, welding torch for the narrow gap including flux feeding nozzle, flux recovery nozzles are successively installed in the head. Additionally, the laser vision camera is attached in front of these devices.

In this project, the laser camera should cover the range of the thickness of the welding plate, which ranges from 30 to 250 mm thick. The laser-camera Mini-260 model provided by Servo-Robot has a depth-of-field of 260mm. This camera can capture the images of deep groove from the position above the plate surface. The other specifications of this camera are described below and in Figure 4.

Stand-off : 77mm
 Field-of-view : close-38mm, far-122mm
 Average depth resolution : 0.05mm
 Sample points per profile : 478 or 239
 Data rate : 14340 points per second
 Dimensions : 69mm×66.7mm×24mm

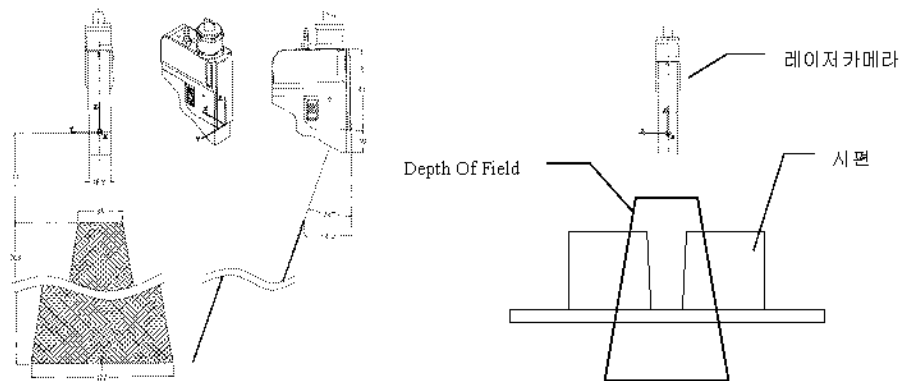

Figure 4. Mini-260 laser vision camera and joint capture

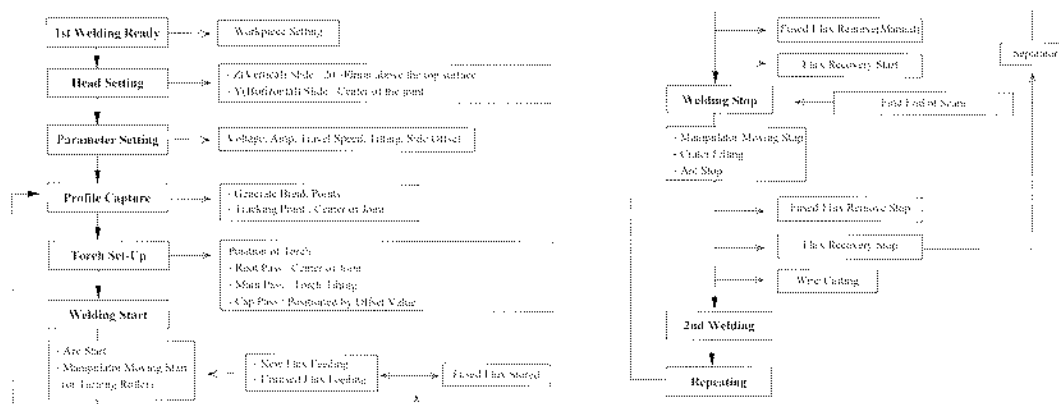

Figure 5. Welding sequence of girth seam welding

The welding sequence of girth seam welding is illustrated in Figure 5[3][4].

3. Multi-pass Welding Strategy

The narrow gap multi-pass welding strategy is the rule of thumb which governs the whole system so as to be in harmony with the laser vision system, welding power supply and other peripheral devices. Also it is the target for designing interfaces between the laser vision system and the servo system.

- 1) The depth of the narrow gap and the width of every current layer must be measured in real-time by a laser vision camera and the residual area of the cross section should be calculated by a vision system.
- 2) On the root pass, the torch should be controlled so as to be located at the center of the gap.
- 3) In the case of girth seam welding, the second pass of the main layer shall be welded continuously after finishing the first pass. Before the welding of the second pass, a specific overlap step is applied.
- 4) The offset distance of the wire tip from the sidewall will be the same as the wire diameter in the main layers. The other pitches are divided by same pitch and/or specific pitch to be selected. But in this project, there are only two passes on the same layer, and the offset distance of the wire tip will be controlled by the torch angle tilting action.
- 5) The laser vision system should control the tracking position of the torch and simultaneously the speed of the turning roller to maintain the same line speed according to heaping of the beads.
- 6) The position of overlap should not be at the same location on each layer to maintain the same bead thickness and

prevent bead cracking.

- 7) Adaptive deposit control should be done according to the residual area of the cross section.
- 8) Adaptive weld speed control should be done according to the residual area of the cross section or the location of layers.
- 9) After measuring the width and residual thickness of the gap to be welded, the laser vision system should calculate the required number of passes and pitches.
- 10) Adaptive functions should define the cap level.
- 11) Sensing of one-turn will be made by calculation of the inside circumference of the work piece and encoder attached to the work piece.
- 12) Interfaces with the laser vision system will be as follows,
 - Arc Start/Stop, Power Supply A/V Control, Flux Feeding Start/Stop, Flux Recovery Start/Stop, Turing Roller Start/Stop & Start/Stop delay, Turning Roller Speed Control, Encoder Count, etc.
- 13) An example of the narrow gap joint is as follows and as shown in Figure 6.

Groove : U-Groove
 Bevel Angle : 1 ~ 3 degree
 Depth : 50 ~ 270mm
 Root Gap : Radius 9 ± 1 mm

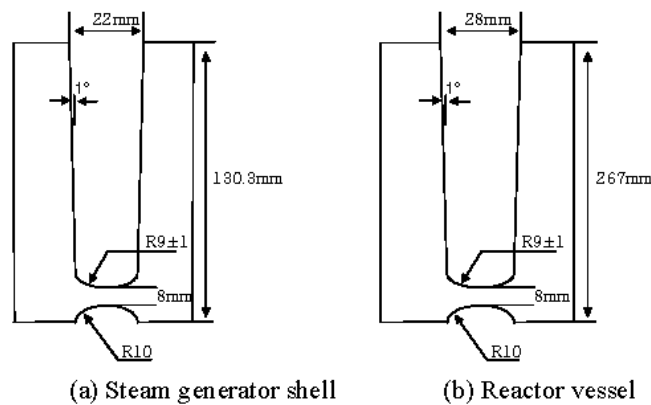

(a) Steam generator shell (b) Reactor vessel
 Figure 6. An example of the narrow gap joint

VISUS software is the main program used for image processing in the laser vision system[5]. The raw image data from the vision camera is processed for capturing the profile of the groove and defining the breakpoints. VISUS has some joint models, such as corner, lap, butt, and fillet joints, but in this project, J-groove joint was selected because the target groove joint is a narrow gap. The processed breakpoints can be seen in Figure 7.

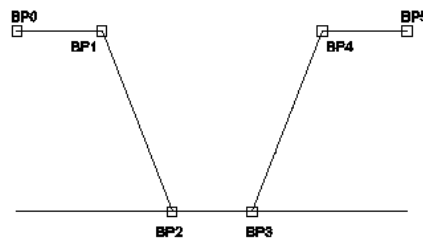

Figure 7. Breakpoints of V-groove joint

In the VISUS program, there are four important parameters to be set carefully: processing method, plate thickness, joint normal method, and area calculation method. There are four other different methods to find breakpoints 2 and 3 in the processing method parameters: root pass search, root pass search based on plate thickness, layer detection by inflection point, and layer detection by line fitting.[6]

In the root pass search, the edges of both sides of the root gap are calculated by finding breakpoints 2 and 3. But in this method, the laser camera is too sensitive to the reflectivity of the base surface and noise. In the layer detection by inflection point, as in Figure 8, breakpoints 2 and 3 are appointed at the inflection point where the sidewall meets the

bead. In the layer detection by line fitting method, after making the optimum line between the inflection points, breakpoints 2 and 3 are appointed at the cross point with the side wall and this line, as shown in Figure 9.

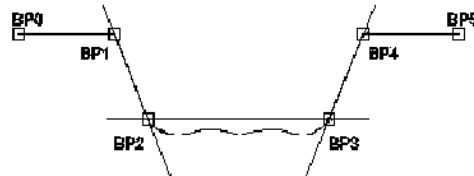

Figure 8. Layer detection by inflection points

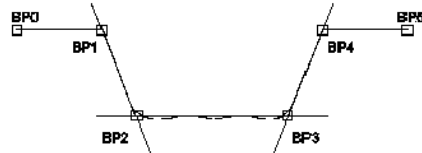

Figure 9. Layer detection by line fitting

4. Image Processing of the Narrow Gap

The capturing capability of the narrow gap joint of the laser vision system has been tested with the work piece which has 25mm of upper gap, 18mm of root gap and 150mm of depth as shown in Figure 10. In this figure, the Mini-260 laser camera and its laser beam projected diagonally to maximize the capturing ability can be seen.

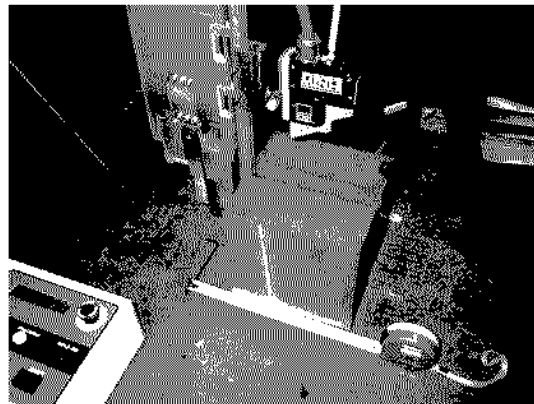

Figure 10. Profile capturing test of the narrow gap joint

Because the resolution at the close plane of the depth-of-field is higher than that of the far plane, it is recommended that the upper surface should be captured at the close plane of the depth-of-field. But it should be careful not to stray out of narrow depth-of-field during seam tracking. The result of joint profile capturing of the narrow gap and signal intensity is shown in Figure 11. The intensity display is maximum at the upper surface and minimum at the corner of the root gap. The narrow gap joint profile was processed successfully and 6 breakpoints and tracking points are also distinctly marked on the profile. The measured root gap is 17.95mm and upper gap is 24.9mm. The measurement error is 0.05mm and 0.1mm.

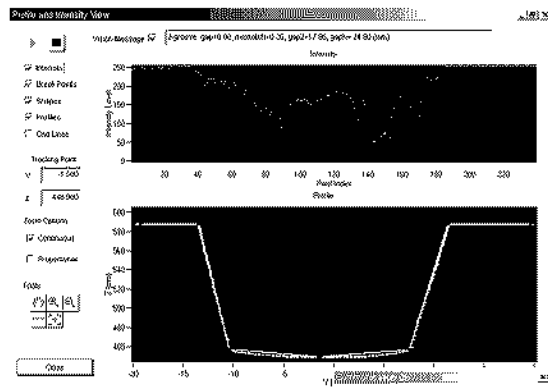
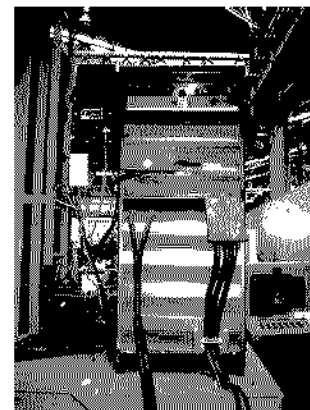
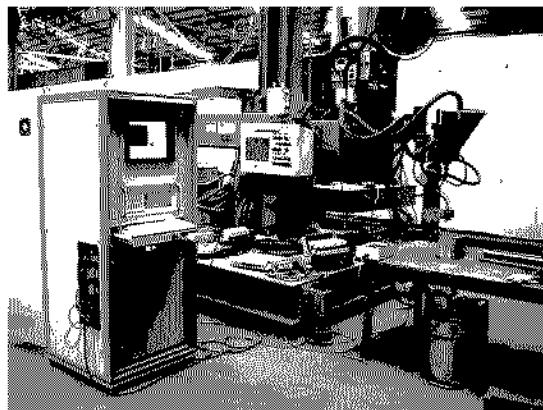

Figure 11. The result of joint profile capturing of the narrow gap

WinUser, the user interface program of Servo-Robot, provides statistical measurements used to inspect resolution. By running this program we find that the mean value of the root gap is 17.99mm and the standard deviation is 0.186. During the tracking sequence, the measured seam points are line fitted by a trajectory generator making the torch move along the way smoothly.

5. Welding Test

We have made and installed a proto type of the automation system of narrow gap welding which consists of the laser vision system, welding manipulator, control panel, welding power supply, flux feeder and recovery as shown in Figure 12. The PC on which the WinUser program runs, the PLC which controls system sequences, AC servo drivers, and the laser vision system are integrated in the 19 inch rack. A remote control box to be installed on the boom slide in case of using a huge manipulator has been made enables the operator to monitor and control everything remotely. Lincoln DC1500 and NA-5 are used and interfaced with the laser vision system as a welding power supply.



(a) Full automation system (b) Lincoln DC1500 welding power supply

Figure 12. Automation system of narrow gap welding

The welding voltage was set to 28V and current was set to 350A. The diameter of wire was 4 mm. In the DC1500 model, welding current means the speed of wire feeding. The SAW welding test has been done as in Figure 13. The flux used was exclusive for narrow gap and it was fed into joint gap at the same time as the wire touched the work piece. The laser vision scanned the front area of the seam line.

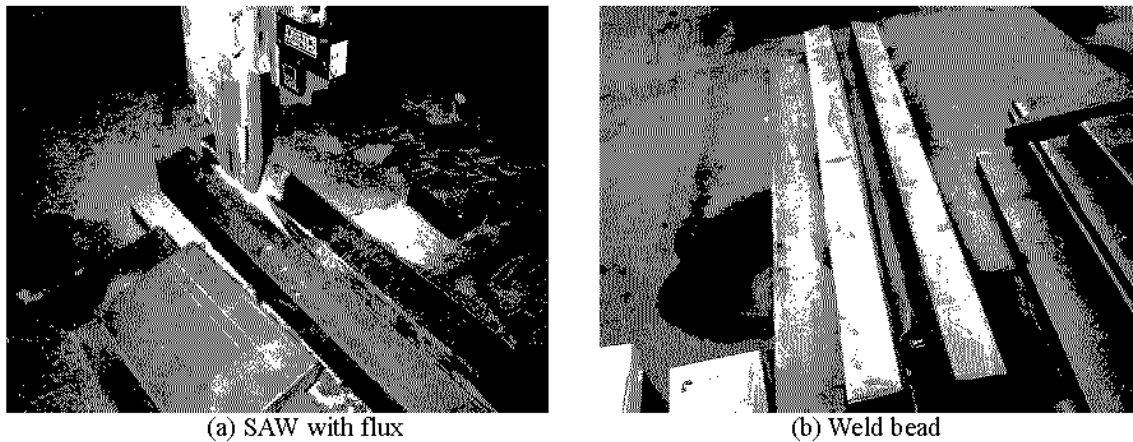
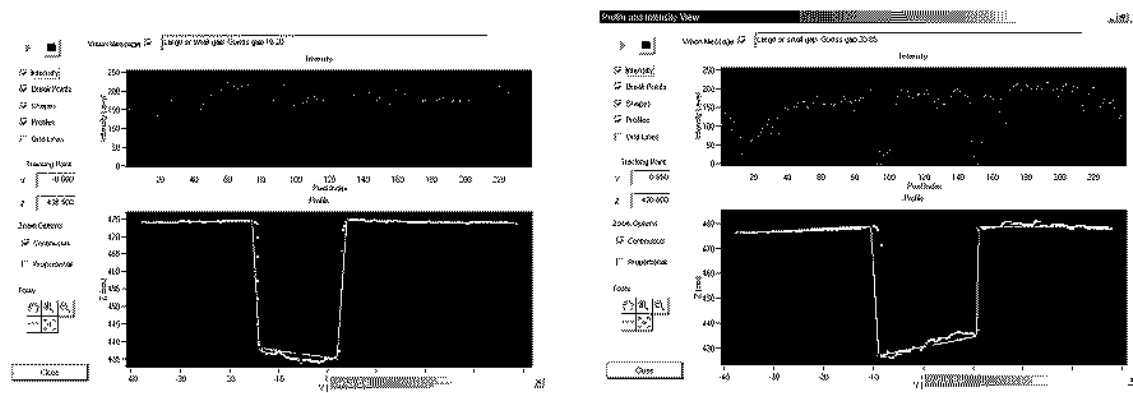

Figure 13. Welding test on the long seam line

As a result, the full sequence control and the seam tracking by the laser vision system have been carried out successfully. Arbitrary errors or emergency stops by trivial disturbances such as tips in the joint have never occurred. The bead shapes were very uniform and linear. The laser vision system was programmed to track the center of the bottom joint, and there should be two passes per one layer, so the tilting angle of the torch was controlled by a preset value. The torch angle should not be changed during welding because the joint gap does not change along the layers in narrow gap.

The result of narrow gap joint profile capture and signal intensity is shown in Figure 14. (a) means the profile capture and break points on second layer, (b) means the profile and break points on 4th layer. The tracking point was calculated very precisely by the processing method of "Layer detection by inflection points". Because the bead surface was very rough, the tracking point could have been altered by the processing method but the error was only 1 or 2 mm, so it did not influence the seam tracking or bead shape.



(a) Profile capture on the 2nd layer

(b) Profile capture on the 4th layer

Figure 14. Profile capture and break points during welding

6. Conclusion

This project was performed with the support of the Ministry of Commerce, Industry and Energy as an international joint project. The SAW narrow gap multi-pass welding on thick plates is generally used in heavy industries, for example in the field of manufacturing ship building or pressure vessels. An intelligent automation system for the purpose of uniformity, improved quality of multi-pass welding, and reduction of idle time caused by long process time which would replace skillful welders was required. Servo-Robot Inc has provided a laser vision system and control software, and Doosan Heavy have provided the world's best SAW multi-pass welding technology for this project. Jonghap Machinery also has provided their highly experienced welding automation technology and KIMM has integrated all of these technologies to develop a highly sophisticated system. The multi-pass welding strategy, which is most important in this project, has also been developed in collaboration with KIMM, Servo-Robot, Doosan and Jonghap. I would like to thank them very much.

In this project, the automation system of multi-pass narrow gap SAW using the laser vision system has been developed,

and the narrow gap multi-pass welding by this system has proven its reliability. Great improvements have been made when compared with the previous automation system of V-groove welding. The capability of finding break points and tracking points even on the deep and narrow gap during welding has become much more reliable, seam tracking has been carried out very precisely with the user interface program, and WinUser has proven very convenient to set parameters and monitor profiles and retrieve useful information.

I would like to believe that these automation systems will contribute highly to improve the productivity and quality in heavy industries where multi-pass narrow gap SAW is mainly used.

Acknowledgments

This project has been supported by the Ministry of Commerce, Industry and Energy (C00-99C-1104-02-1-2).

References

- [1] H. C. Park, "Development of Automatic Welding System By Using Laser Vision System", KIMM, Sep. 1997.
- [2] H. C. Park and Y. H. Jung, "The Development of Narrow Gap Multi-pass Welding System Using Laser Vision System", KIMM, Sep. 2002.
- [3] H. C. Park and L. Didier, "The Development of SAW Multi-pass Welding System Using Laser Vision System", Proceedings of 32nd ISR, Apr. 2001.
- [4] H. C. Park and K. H. Song, "Development of Automatic SAW Multi-pass Welding System by Using Laser Vision System", KIMM, Nov. 1998.
- [5] J. P. Boillot, "Servo-Robot Inc.'s Multi-pass Welding System", Servo Robot, 1997.
- [6] J. P. Boillot, "MULTI User Manual", Servo Robot, 1998.