

R600a용 리니어 압축기 (Linear Compressor for R600a)

김정우

 LG 전자(주) DA 연구소 Comp Gr.

LGE's Linear Compressors

R134a

R600a

1st Model

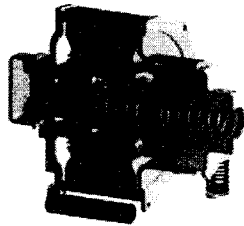

2nd Model

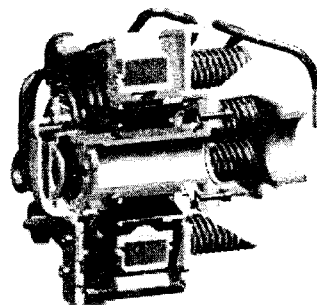
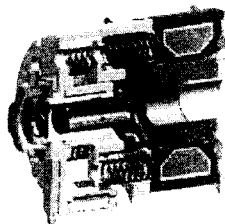

Theoretical Comparisons, R134a / R600a

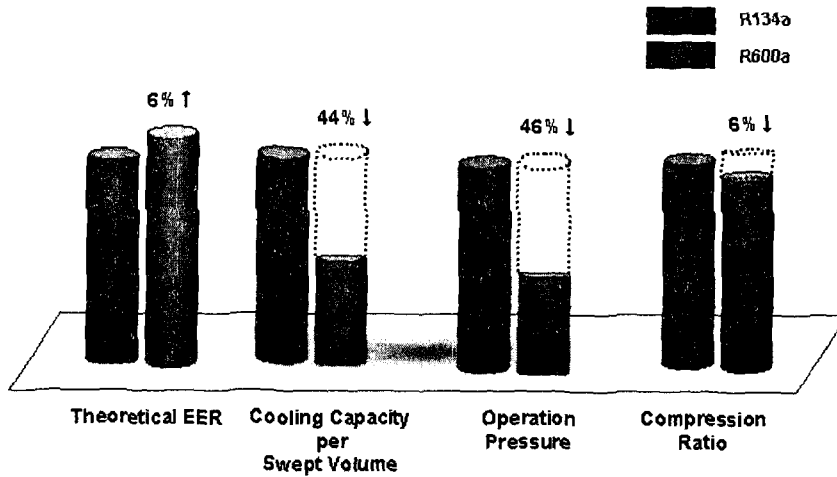

3/14



Piston and Cylinder

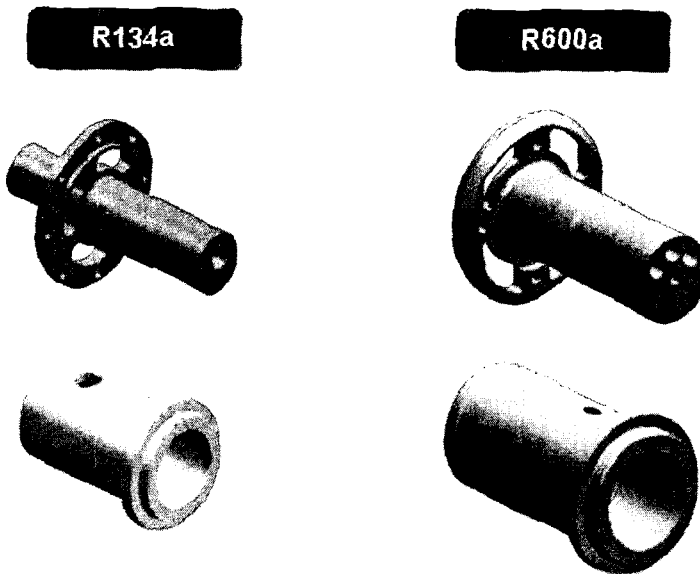

4/14



Spring

R134a

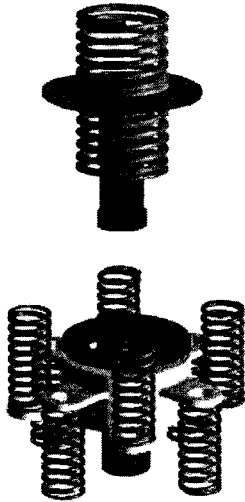

R600a

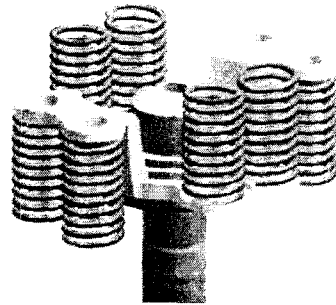

5/14



Linear Motor

R134a

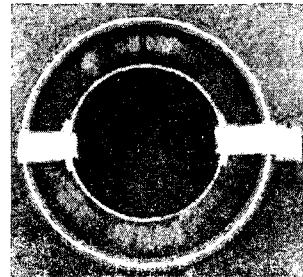

R600a

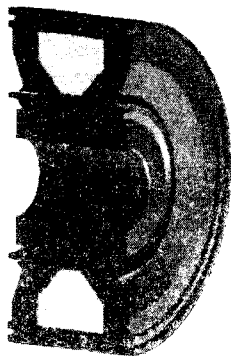
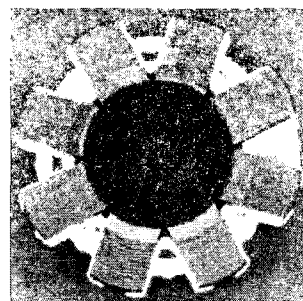

6/14



Muffler Tuning

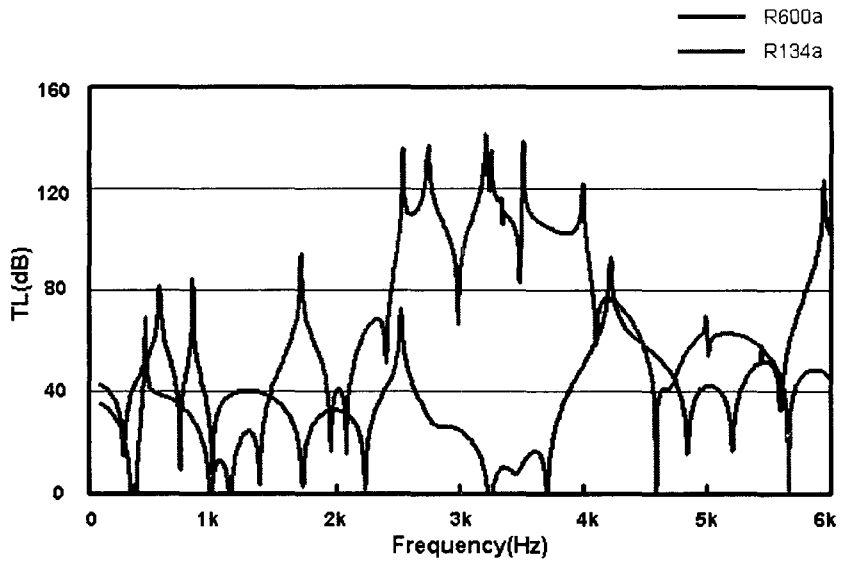

7/14



Hardware of Controller

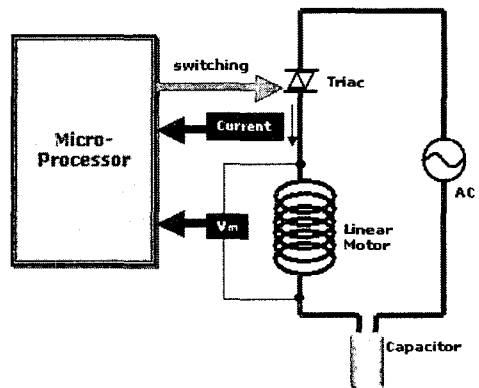
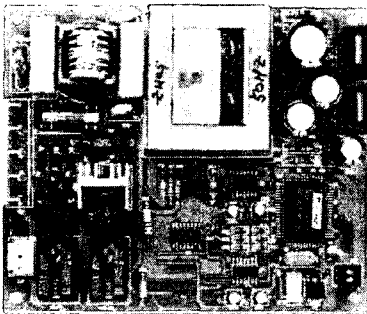

8/14



TDC Searching by Controller

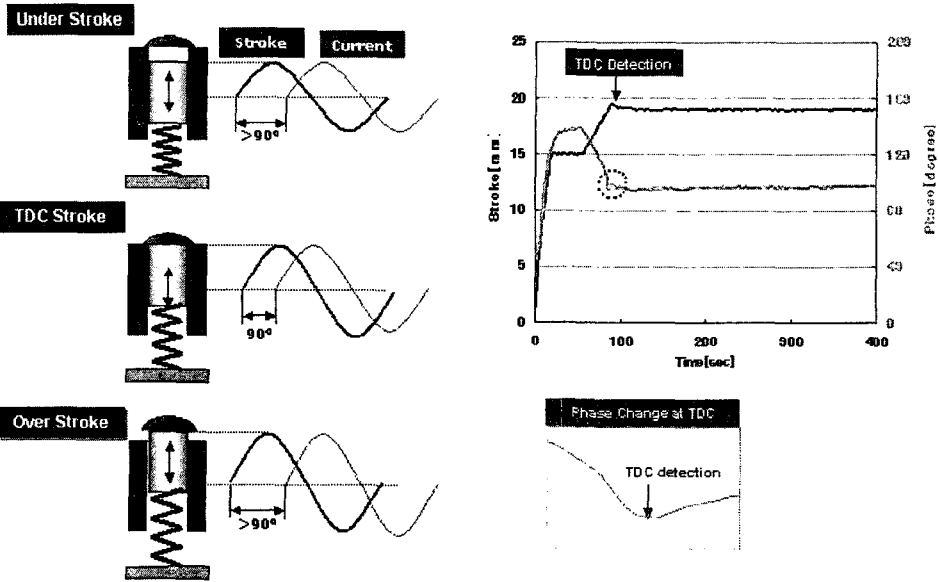

9/14



Compressor Efficiency

EER (Including Drive Loss, 38/26 °C Condition)

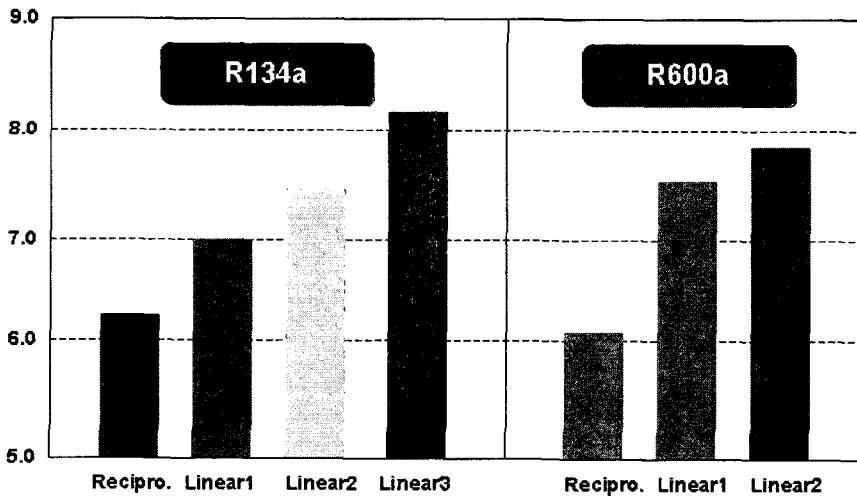

10/14



Characteristics of Capacity Control

EER (Including Drive Loss, 38/-26°C Condition)

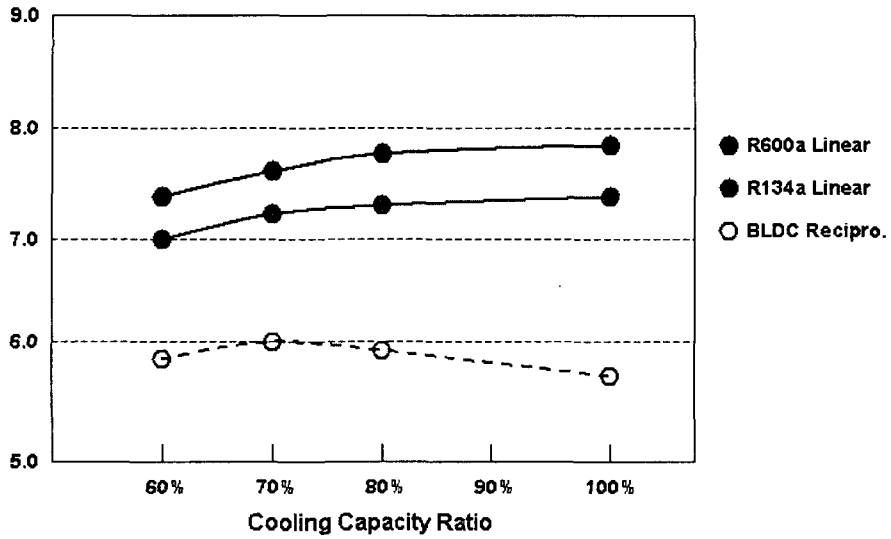

11/14



Noise Characteristics

SPL(dBA)

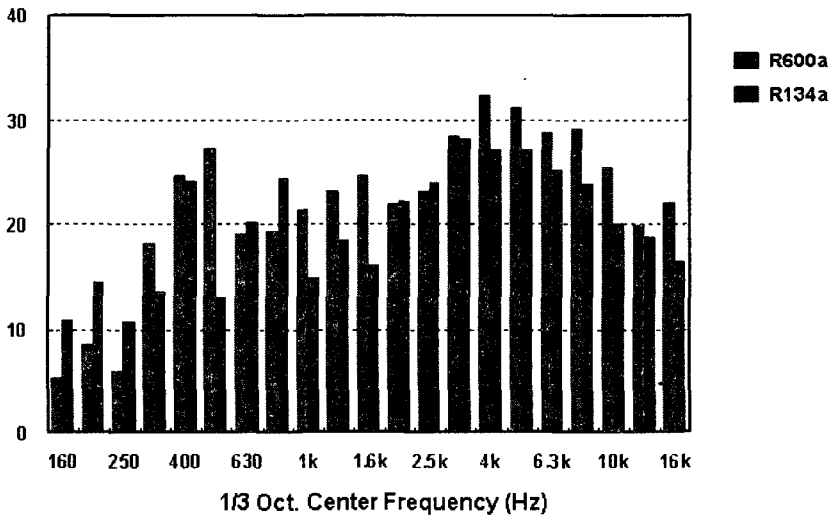

12/14



Energy Saving with R600a Linear Compressor

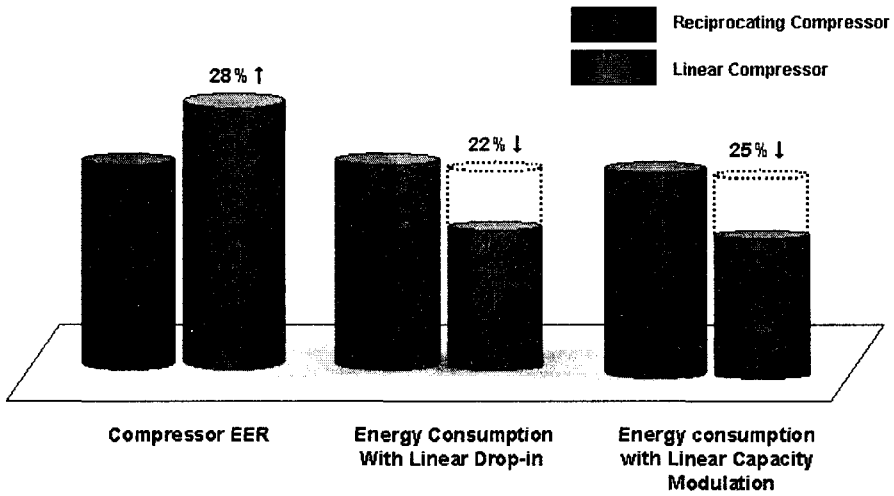

* Tested with refrigerator & freezer for European market in 2002

13/14



Linear Compressor for R600a

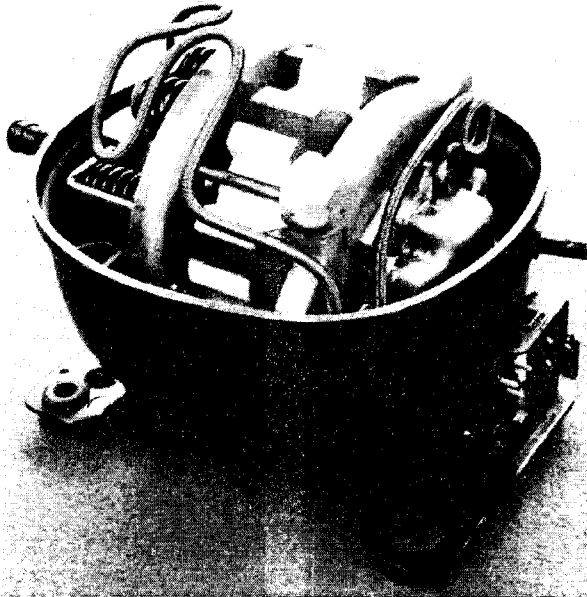

14/14

