

# A DESIGN OF SMALL DATA UTILIZATION SYSTEM FOR THE COMS

Seok-Bae Seo, In-Hoi Ku, Chi-Ho Kang, Hyun-Su Lim, and Sang-IL Ahn

Korea Aerospace Research Institute  
P.O. Box 113, Yuseong, Daejeon, Korea  
sbseo@kari.re.kr

## ABSTRACT:

COMS (Communication, Ocean, and Meteorological Satellite) will be launch at end of year 2008. For receiving of COMS LRIT, KARI (Korea Aerospace Research Institute) finished design and software realization of COMS SDUS (Small Data Utilization System). SDUS is a small station receiving LRIT data for distribute satellite image, weather information, and so on. For the future project, KARI preparing COMS MDUS (Mass Data Utilization System) that can receiving large size of data over than 2M BPS (Bit Per Seconds) data size.

**KEY WORDS:** COMS, SDUS, MDUS, LRIT, HRIT

## 1. Introduction

COMS will be launch by KARI at end of year 2008. COMS has two type of services that SDUS and MDUS. Both of systems consist hardware and software as conventional system. The hardware separated in two systems - receiving system and processing system. In this paper assure that all of hardware system is working well for software system design. Here working well means SDUS receiving no error CADU that consisted 4 byte sync code (1A CF FC 1D h) and 1024 byte data with ECC (Error Correction Code). Fig. 1 shows a rough design of COMS SDUS configuration [C.H. Kang 2004].

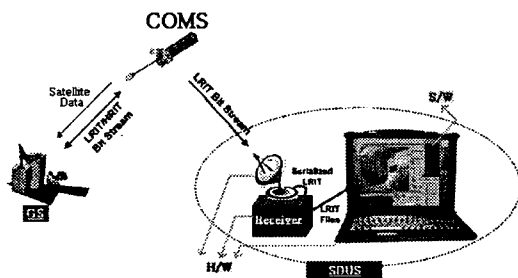

Fig. 1. COMS SDUS configuration

## 2. COMS SDUS design

Fig. 2 shows COMS SDUS and COMS SDUS SS (Support System). PC 1 is configuration of COMS SDUS SS and PC 2 is COMS SDUS in Fig. 2. Dark boxes in Fig. 2 are H/W part, therefore assure that they will work well and explain roughly.

## 3. COMS SDUS Support System

Fig. 2. COMS SDUS and COMS SDUS SS

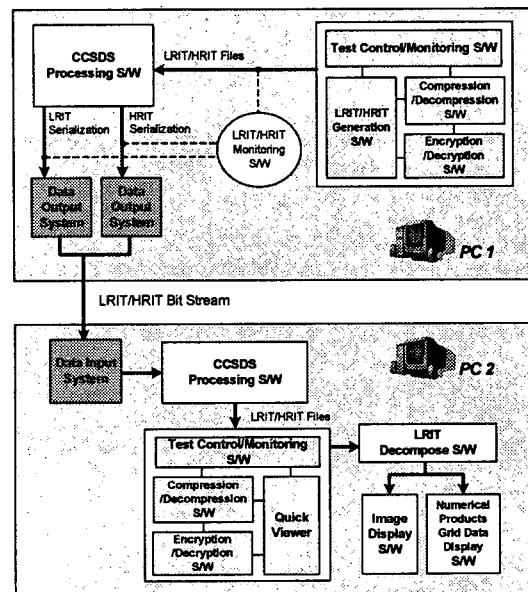

COMS SDUS SS is designed for verification for COMS SDUS that makes satellite data and LRIT bit stream in Fig. 1 by predefined schedules. As additional function, COMS SDUS SS can measure distance from GS (Ground Station) to COMS. Fig. 3 shows block diagram of PDR (Product Data Ranging) S/W of COMS. PDR S/W measures distance using up and down link timestamp.

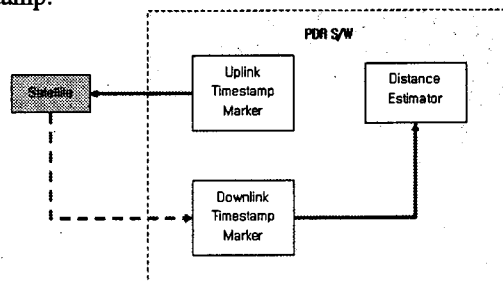

Fig.3 PDR S/W

Fig. 4 shows consist of LRIT Generation S/W of

COMS SDUS SS. COMS LRIT based on CGMS LRIT/HRIT Specification. LRIT Generation S/W convert from received data from COMS to transportable format data via LRIT communication channel. More detailed information of COMS LRIT is explained in 'The MSG Ground Station LRIT/HRIT Mission Specific Implementation' document. COMS LRIT generation S/W has two inputs. NWP (Numerical Weather Prediction), first input data, is supplied from KMA (Korea Meteorological Agency). Because of there are no images of COMS, the GOES-9's Image data used COMS LRIT input image data instead of COMS ones.

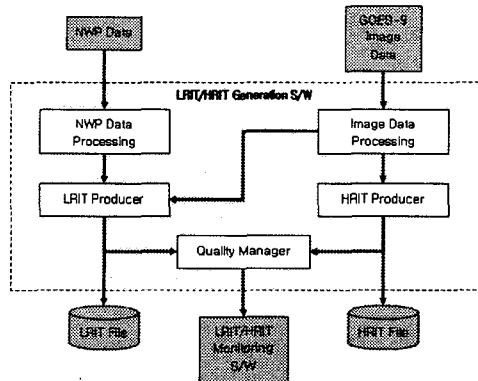

Fig.4 LRIT Generation S/W

Fig. 5 explains consist of COMS LRIT monitoring S/W. The S/W surveilles all of COMS LRIT generation processes.

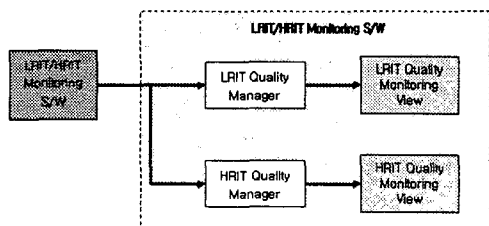

Fig.5 LRIT Monitoring S/W

Fig. 6 explains consist of COMS LRIT Test Control/Monitoring S/W. The S/W helps to user can controlling and monitoring test of LRIT receiving, display, and quality checking.

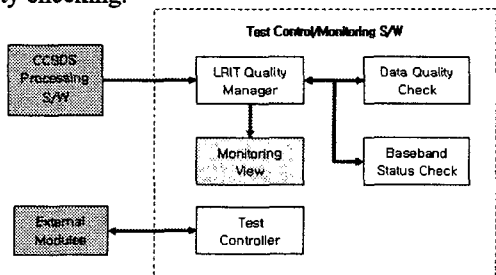

Fig.6 LRIT Test Controlling/Monitoring S/W

Fig. 7 explains consist of COMS LRIT CCSDS processing S/W. The S/W makes bit stream as CCSDS recommendations for data transmit.

Fig. 8 explains consist of COMS LRIT Compression/Decompression S/W.

COMS LRIT compression/decompression compliances with Lossy and Loss-less JPEG standards.

Fig. 9 explains consist of COMS LRIT Encryption/Decryption S/W. COMS LRIT encryption/decryption compliances with DES (Data Encryption Standard).

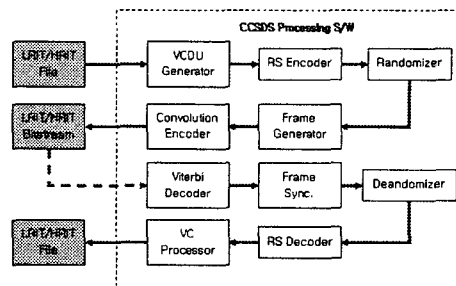

Fig.7 LRIT CCSDS Processing S/W

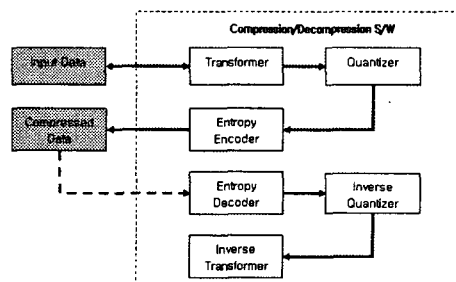

Fig.8 LRIT Compression/Decompression S/W

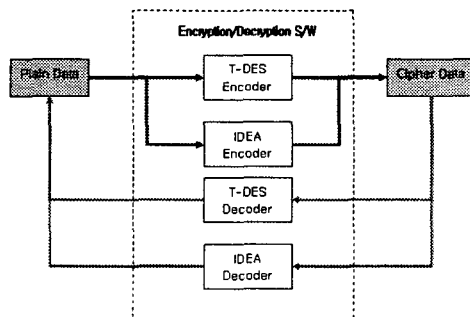

Fig.9 LRIT Encryption/Decryption S/W

#### 4. COMS SDUS

Fig. 10 explains detail block diagram of COMS SDUS, and Fig. 11 explains Receiver Monitoring S/W of COMS SDUS. COMS LRIT Monitoring S/W is monitoring status of COMS LRIT Receiver H/W like small size antenna, LNB (Low Noise Block), Demodulator, and so on. We suppose Output data of Receiver Monitoring S/W has no error.

Fig. 12 explains consist of Receiving Schedule S/W. Receiving Schedule of COMS LRIT is based on the KMA Users Requirements. TM (Telemetry) is a status data from data input system of COMS SDUS.

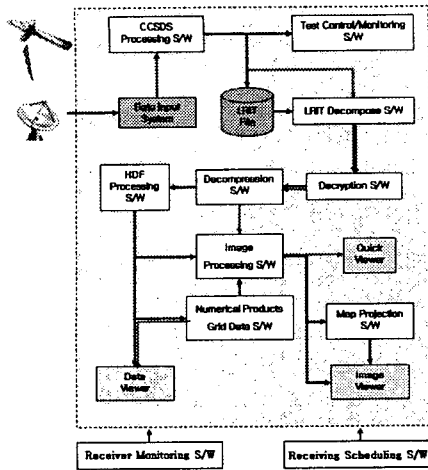

Fig.10 Detailed Block Diagram of COMS SDUS

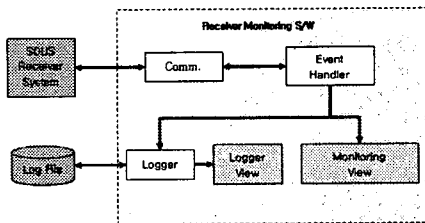

Fig.11 LRIT Receiver Monitoring S/W

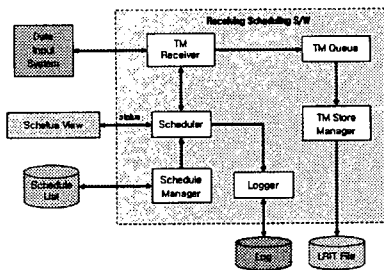

Fig.12 LRIT Receiving Scheduling S/W

Fig. 13 explains consist of COMS LRIT Quick Viewer. The Quick Viewer displays image and qualities of current receiving LRIT data.

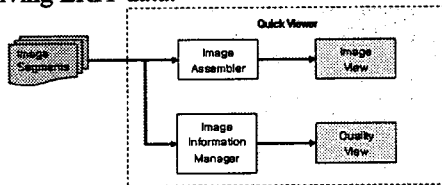

Fig.13 LRIT Quick Viewer

Fig. 14 explains consist of COMS LRIT Decomposition S/W. This S/W converts from received LIRT data to convenient data for COMS LRIT data processing.

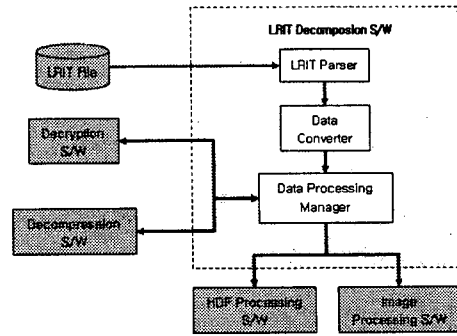

Fig.14 LRIT Decomposition S/W

Fig. 15 explains consist of COMS LRIT HDF5 and HDF5-EOS (Earth Observing System) File Processing S/W. Here, HDF (Hierarchical Data Format) is a data format for various mass data change that developed by the NCSA (National Center for Supercomputing Applications) [NCSA 2005].

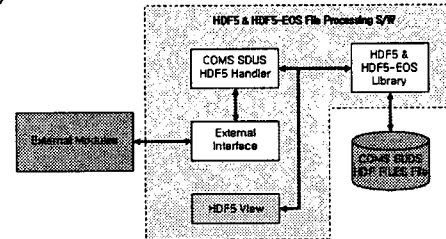

Fig.15 LRIT HDF5

Fig. 16 explains consist of COMS LRIT Geographical Location S/W. The S/W supports transform between pixel coordinate and geodetic coordinate with each other.

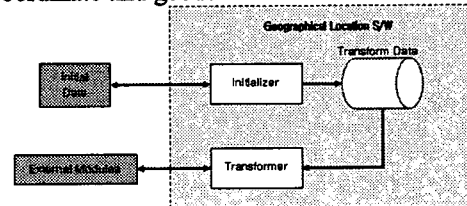

Fig.16 LRIT Geographical Location S/W

Fig. 17 explains consist of COMS LRIT Image Display S/W. So COMS image size is large, that the S/W needed supporting of partial image processing.

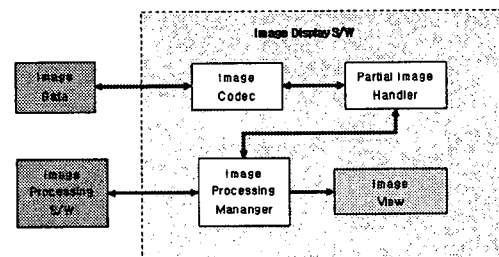

Fig.17 LRIT Image Display S/W

Fig. 18 explains consist of COMS Image Processing S/W. The S/W has function of enhancement, filtering, zooming, band combination, and so on for COMS LRIT Images.

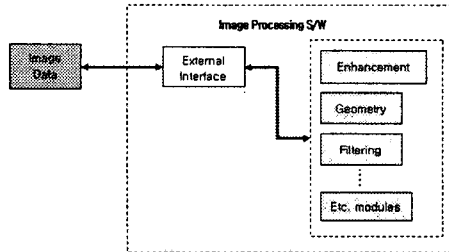

Fig.18 LRIT Image Processing S/W

Fig. 19 explains consist of COMS LRIT Image Generation S/W. The S/W can save to BMP, JPEG, and TIFF image format for partial or whole image from COMS SDUS S/W.

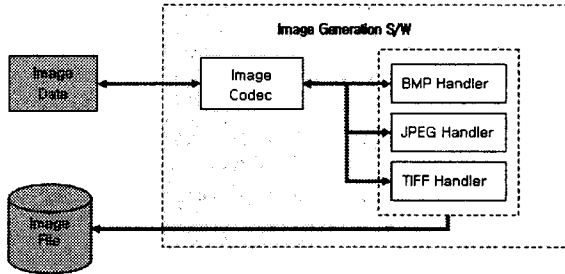

Fig.19 LRIT Image Generation S/W

Fig. 20 explains consist of COMS LRIT Map Projection S/W. The S/W supports transform among polar-stereographic, Lamber conformal conic, Mercator, perspective, and normalized geostationary with one another.

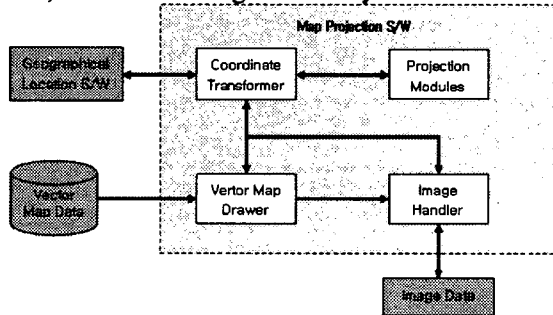

Fig.20 LRIT Map Projection S/W

Fig. 21 explains consist of COMS LRIT Meteorological Product Display S/W. The S/W supports display like plotting, thermodynamic display, cross-section, stability index calculation and display, and objective analysis to produce grid values.

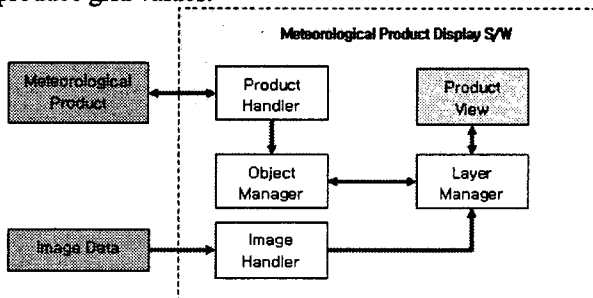

Fig.21 LRIT Meteorological Product Display S/W

Fig. 22 explains consist of COMS LRIT Numerical

Product Generation S/W. The S/W makes meteorological products using COMS LRIT images and numerical predictive data.

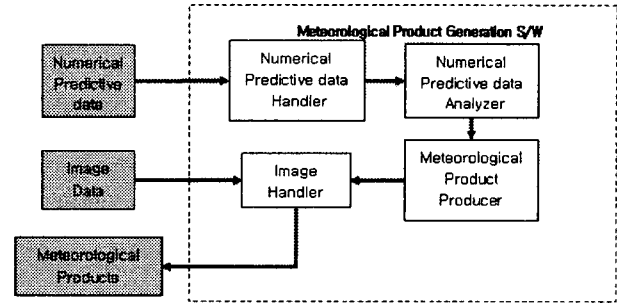

Fig.22 LRIT Numerical Product Generation S/W

Fig. 23 explains consist of COMS LRIT Numerical Products Grid Data Display S/W. The S/W displays numerical products grid data and overlays plotting, contour, and so on.

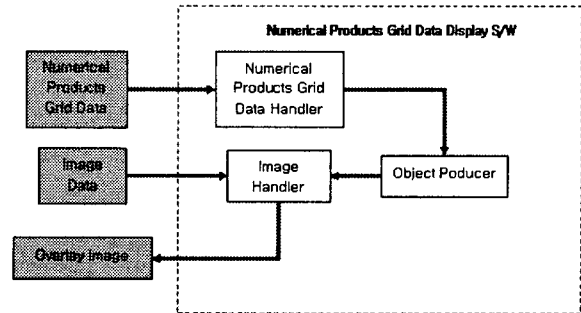

Fig.23 LRIT Numerical Products Grid Data Display S/W

Fig. 24 explains consist of COMS LRIT Meteorological Observation Data and Administration Message Display S/W. The S/W supports observation and administration of H/W like small size antenna, LNB, demodulator, and so on.

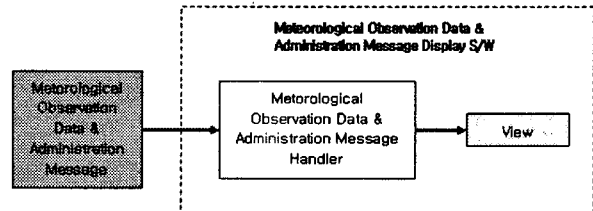

Fig.24 LRIT Meteorological Observation Data and Administration Message Display S/W

## 5. Conclusions

This paper explains current states of COMS SDUS design researching in KARI. We expect that SDUS will carry out as good small data utilization System for COMS after COMS launching.

## References

- [C.H. Kang 2004] The Global Perspective Plane Image Generation using the GOES-9 Satellite Images, KARI Technical Memo, KOREA.
- [NCSA 2005] NCSA HDF-EOS Project Homepage <http://hdf.ncsa.uiuc.edu/hdfeos.html>