

High Efficacy and High Speed Addressing of a Spatial Positive Column Discharge PDP

T. Shiga and S. Mikoshiba

Dept. of Electric Engineering, The Univ. of Electro-Communications, Chofu,
Tokyo, Japan

Phone: +81-42-443-5178, E-mail: shiga@ee.uec.ac.jp

Keywords: plasma display, PDP, luminous efficacy, positive column discharge

Abstract

Luminous efficacy of 6.0 lm/W has been realized by introducing a spatial positive column discharge together with delayed D pulses, shared sustain pulse voltage, and low sustain frequency drive. Also a high speed addressing of 0.25 μ s was achieved. The luminance was 157cd/m², which is high enough for a 260-in. FHD display.

1. Introduction

A thick film ceramic sheet (TFCS) PDP [1] provides a long sustain discharge gap, enabling a use of the positive column discharge, which gives higher efficacy compared with the negative glow discharge. Also the structure utilizes "spatial discharges". Figure 1 compares the conventional "surface discharge" and the spatial discharge. The spatial discharges are completely free from touching the surface of

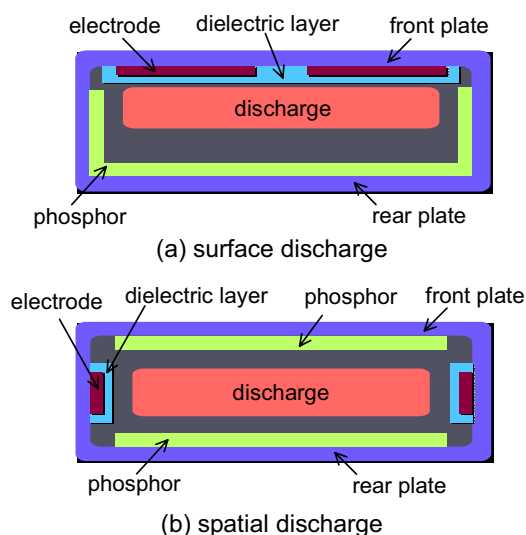

Fig. 1. Cross sectional view of discharge.

substrates and hence reducing diffusion losses. This enhances the efficacy improvement. A further efficacy improvement with the delayed D pulses which are applied to data electrodes during the sustain period has been proposed [2]. The pulses introduce wall-charge-induced perturbation of the electric field, reducing the peak discharge current, resulting in higher efficacy and luminance. In this paper, the efficacy improvement with the delayed D pulses and a driving method integrating the delayed D pulses will be discussed.

2. Panel Structure and Driving Waveforms

A structure and the cross sectional view of a PDP used for the experiments is shown in Figs. 2 and 3 [1]. The diagonal size of the panel is 5.4 inches, with discharge-cell pitches 1mm horizontally and 0.75mm vertically. A 3x4 discharge-cell block consists of a 3mm x 3mm pixel. This yields large-area pixels by using the conventional fabrication techniques. Ne+Xe (30%) is admitted at $p=47$ kPa or 60kPa. Barrier ribs

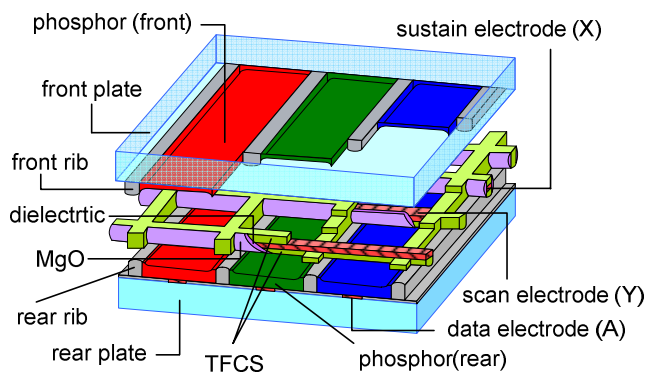

Fig. 2. Structure of thick film ceramic sheet (TFCS) PDP.

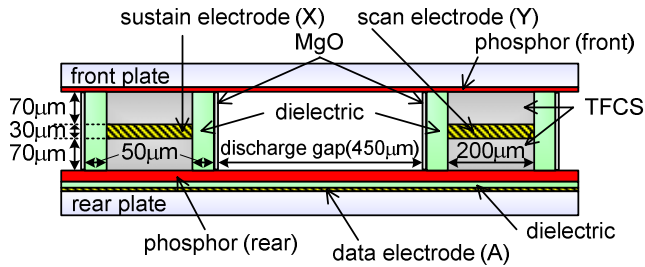

Fig. 3. Cross sectional view of TFCS PDP along the data electrode.

are made of thick film ceramic sheets (TFCS) and the sustain electrodes (X) and scan electrodes (Y) are sandwiched between the sheets. The structure provides a sustain discharge gap of 0.45mm, enabling a use of the high efficacy positive column discharge.

Figure 4 shows drive voltage waveforms which adopts the contiguous subfield, erase addressing scheme [3]. The driving of a full HD panel with a single scan mode was assumed. The delayed D pulses, V_{delayD} , are applied to the data electrodes with a delay, τ_{delay} , from the leading edge of the sustain pulses. Note that the last two delayed D pulses are eliminated (denoted as $N=2$ for a future use).

3. Efficacy Improvement with Delayed D pulses

Figure 5 shows the applied waveforms of sustain voltage and delayed D pulse voltage, and discharge current waveforms of X and A electrodes when

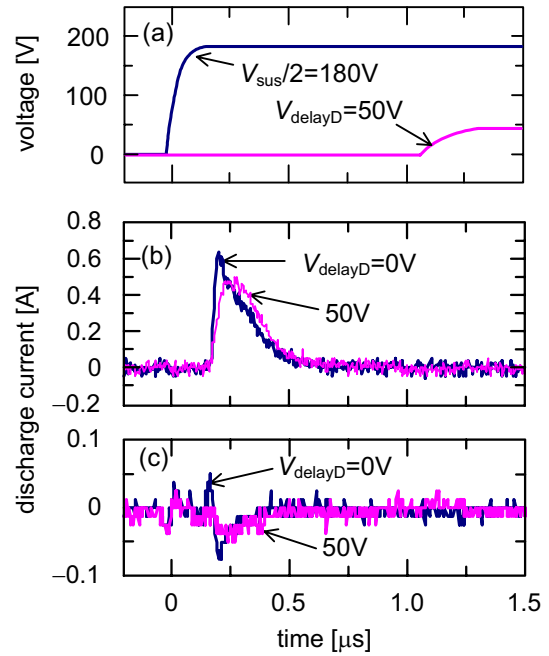

Fig. 5. Applied voltage and discharge current waveforms for 4 vertical and 32 horizontal pixels, $p = 60 \text{ kPa}$. (a) voltages, (b) sustain electrode current, (c) data electrode current.

$V_{\text{delayD}}=0$ and 50V with $\tau_{\text{delay}}=1\mu\text{s}$. The displacement current was eliminated from the traces. It can be seen from the figure that the discharge current build-up slows down and the peak value decreases with an application of 50V to the delayed D pulse. There is no discharge current on X and A electrodes when the delayed D pulse is applied at $1\mu\text{s}$.

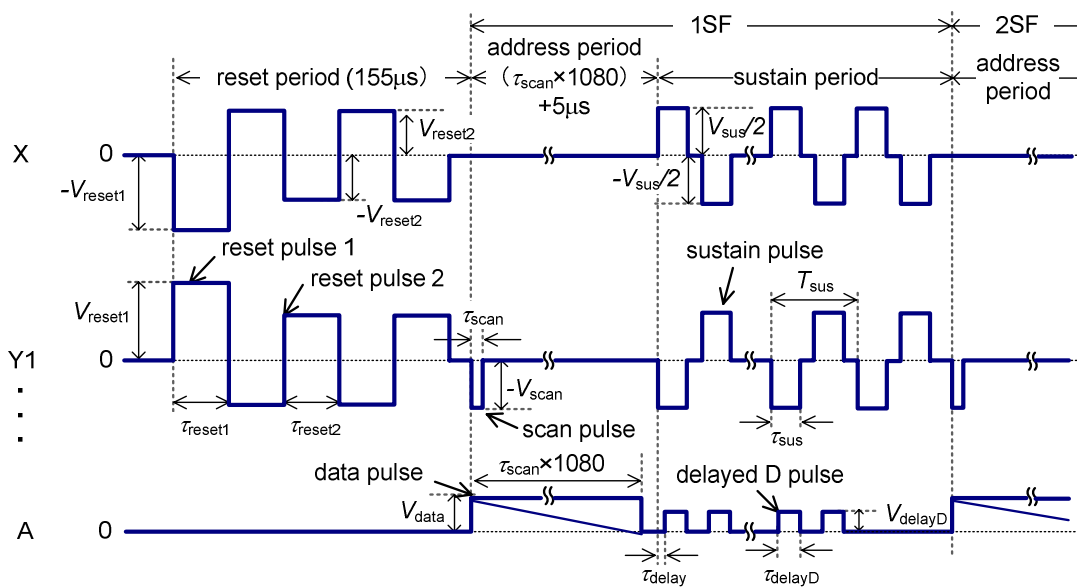

Fig. 4. Drive waveforms for contiguous subfield, erase addressing scheme.

When the delayed D pulse is applied, negative wall charges are accumulated on the data electrode during the application of the preceding sustain pulse. Since the delayed D pulse is applied with the delay, the electric field near the X electrode is perturbed and reduced at the beginning of the sustain pulse. This delays the discharge build-up, resulting in lower current density and higher efficacy.

The τ_{delay} is made longer than the time required for the sustain discharge to be self-terminated by an accumulation of wall charges, but shorter than the time when all the space charges diffuse to the walls.

Various techniques of applying voltage on the data electrode during sustain period have been proposed for the purpose of efficacy improvement [4, 5, 6]. One of the differences between these techniques and the technique presented here is that there is no discharge between X or Y and A electrodes. Therefore there is no extra power consumption.

4. Panel Performance

Figure 6 shows efficacy vs. V_{delayD} . The values obtained when $\tau_{\text{delay}}=0$ are identical to those obtained when $\tau_{\text{delay}}=0.5\mu\text{s}$ and $V_{\text{delayD}}=0$. This is because the field perturbation due to the wall charges on the data electrode are shielded by the V_{delayD} , as explained earlier. When $\tau_{\text{delay}}=0.5\mu\text{s}$, the efficacy improvement of 35% is achieved at $V_{\text{delayD}}=80\text{V}$. With the delayed D pulse, luminance is also increased by 38%. A further increase of V_{delayD} generates relatively strong discharge between X or Y and A electrodes. This reduces the efficacy.

The efficacy can further be improved by lowering

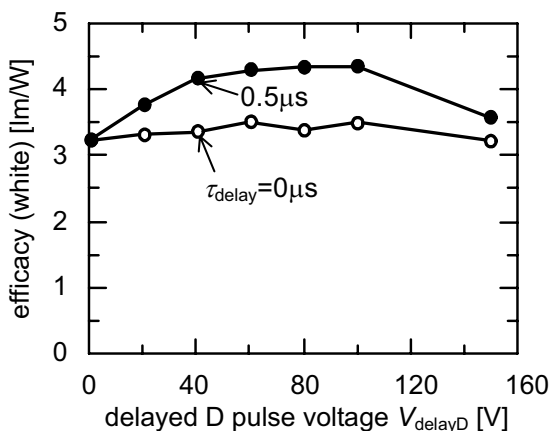

Fig. 6. Efficacy vs. V_{delayD} . $V_{\text{sus}}=360\text{V}$, $T_{\text{sus}}=30\mu\text{s}$, $\tau_{\text{sus}}=10\mu\text{s}$, $p=60\text{kPa}$.

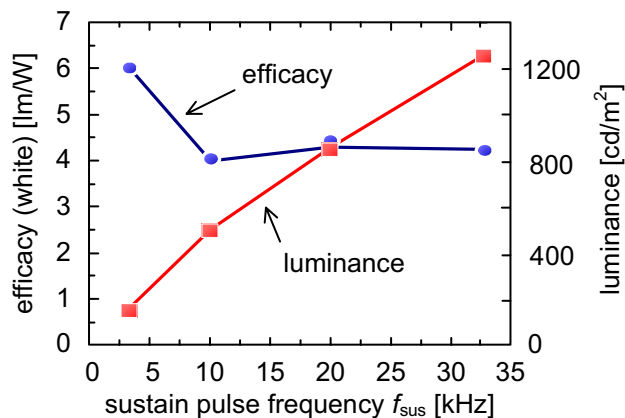

Fig. 7. Luminance, efficacy vs. f_{sus} . $p=47\text{kPa}$. Light-emission duty in a TV field is 70%.

the sustain pulse frequency, f_{sus} , since the phosphor saturation can be reduced. Fig. 7 shows efficacy and luminance vs. f_{sus} . When f_{sus} is 3.3kHz, the efficacy attained the maximum value of 6.0 lm/W in white, although the luminance was reduced to 157cd/m². If one chooses 33kHz, then the efficacy and luminance are 4.2 lm/W and 1,260cd/m². Luminance is approximately proportional to f_{sus} .

5. High Speed Addressing

Figure 8 shows a gradation pattern on the test panel which was used in the dynamic voltage margin measurements. The size of pattern is 4 pixels vertically and 5 pixels horizontally. The dynamic voltage margins of the scan and data pulse voltage when $V_{\text{delayD}}=0\text{V}$ for various scan pulse width, τ_{scan} , is shown in Fig. 9. Although the voltages are little higher than others, the margin of $\tau_{\text{scan}}=0.25\mu\text{s}$ is large enough. The high speed addressing was made possible due to faster build-up of the triggering discharges between

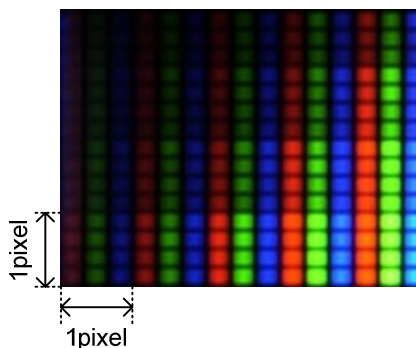

Fig. 8. Gradation pattern expressed on a test panel. (4x5 pixels)

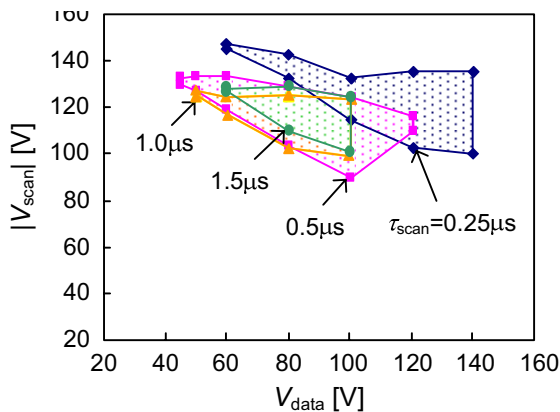

Fig. 9. V_{data} and V_{scan} drive margins for various τ_{scan} . $V_{\text{delayD}}=0\text{V}$, $p=47\text{kPa}$.

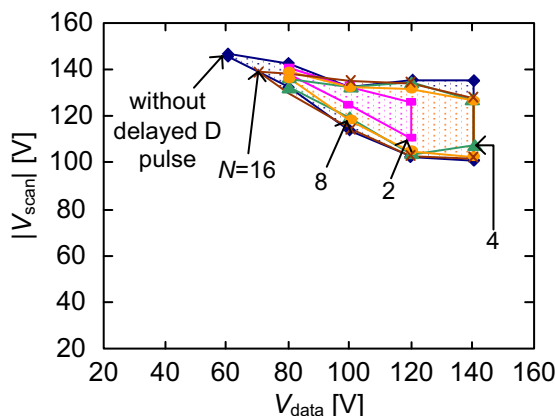

Fig. 10. V_{data} and V_{scan} drive margins for various N . $\tau_{\text{scan}}=0.25\mu\text{s}$, $V_{\text{delayD}}=50\text{V}$, $p=47\text{kPa}$.

X-A and Y-A electrodes which are $70\mu\text{m}$ apart.

When the delayed D pulses were applied at all the sustain pulses, the panel did not function because the negative wall charges accumulated on the data electrode disturb the address operation. The drive voltage margin could be obtained by eliminating the last several delayed D pulses, as explained in Fig. 4.

V_{data} and V_{scan} voltage margins are shown in Fig. 10 for values of N . τ_{scan} is $0.25\mu\text{s}$. As N increases, the margin becomes large. However the effect of efficacy improvement by the delayed D pulses becomes small. Therefore it is concluded that an optimum values of N is 4.

6. Conclusions

The efficacy of the spatial positive column discharge PDP attained 6.0 lm/W in white by introducing (1) positive column discharges, (2) spatial

discharges, (3) delayed D pulses, (4) shared sustain pulse voltage, and (5) reduction of sustain pulse frequency. The luminance was 157cd/m^2 . Alternatively, the panel can achieve 4.2 lm/W and $1,260\text{cd/m}^2$.

Also a high speed addressing of $0.25\mu\text{s}$ was realized. This enables 18 contiguous subfields for the full HD, single scan mode, when light-emission duty is 70%.

Luminance of 157cd/m^2 may seem too low for TV expression. If one considers a full-HD TV display having a pixel pitch of 3mm , then the diagonal size becomes 260 inches with the output luminous flux of $9,200\text{ lm}$. When compared with the flux of 40W fluorescent lamps of $3,000\text{ lm}$, this output flux may even be too high, since the TV display may affect the lighting condition of the room.

7. Acknowledgements

Authors would like to express their thanks to Messrs. T. Sato, M. Ono and Miss N. Kobayashi of The Univ. of Electro-Communications and Messrs. H. Asai and N. Kikuchi of Noritake Co., Ltd. for their support.

8. References

1. S. Mori *et al.*, *Proc. IDW '04*, pp.937-940 (2004).
2. T. Sato *et al.*, *Proc. IDW '06*, pp.1761-1764 (2006).
3. T. Tokunaga *et al.*, *Proc. IDW '99*, pp.787-790 (1999).
4. B.-G. Cho, *et al.*, *SID '02 Digest*, pp.440-443, (2002).
5. K. Yamamoto, *et al.*, *SID '02 Digest*, pp.856-859, (2002).
6. K.-W. Whang, *et al.*, *SID '05 Digest*, pp.1130-1133, (2005).