

Recent Trend of Ultra-Pure Water Producing Equipment

Yoshito Motomura

Kurita Water Industries Ltd.

(Received July 30, 1996)

1. Introduction

Since 1980, the water quality of ultra-pure water has been rapidly improved, and presently ultra-pure water producing equipment for 64 Mbit is in operation. Table 1 shows the degree of integration of DRAM and required water quality example. The requirements of the ultra-pure water for 64 Mbit are resistivity: 18.2 MΩ/cm or higher, number of particulates: 1 pc/ml or less (0.05 μm or larger), bacteria count: 0.1 pc/l or less, TOC (Total Organic Carbon, index of organic substance): 1 ppb or less, dissolved oxygen: 5 ppb or less, silica: 0.5 ppb or less, heavy metal ions: 5 ppt or less. The effect of metals on the silicon wafer has been well known, and recently it has been reported that the existence of organic substance in ultra-pure water is closely related to the device defect, drawing attention. It is

reported that if organic substance sticks to the natural oxidation film, the oxide film remains on the organic substance attachment in the hydrofluoric acid treatment (removal of natural oxidation film). The organic substance forms film on the silicon wafer, and harmful elements such as metals and N. P. S., components contained in the organic substance and the bad effect due to the generation of silicon carbide cannot be forgotten. In order to remove various impurities in raw water, many technological developments (membrane, ion exchange, TOC removal, piping material, microanalysis, etc.) have been made with ultra-pure water producing equipment and put to practical use.

In this paper, technologies put to practical use in recent ultra-pure water producing equipment are introduced.

Table 1. Ultrapure Water Quality Target Values for Semiconductor Manufacturing in Japan

Integration Scale		256 Kbit	1 Mbit	4 Mbit	16 Mbit	46 Mbit	256 Mbit
Items							
Resistivity (MΩ · cm)		17~18	17.5~18	> 18	> 18.1	> 18.2	> 18.2
Particle (number/ml)	0.1 μm	50~150	10~20	< 5			
	0.05 μm			< 10	< 5	< 1	
	0.03 μm					< 10	< 5
Bacteria (number/l)		50~200	10~50	< 10	< 1	< 0.1	< 0.1
TOC (ppb)		50~100	30~50	< 10	< 2	< 1	< 0.5
O ₂ (ppb)		50~100	30~50	< 50	< 10	< 5	< 1
SiO ₂ (ppb)		10	5	< 1	< 1	< 0.5	< 0.1
Metal, Ion (ppt)		~1000	100~500	< 100	< 10~50	< 5	< 1

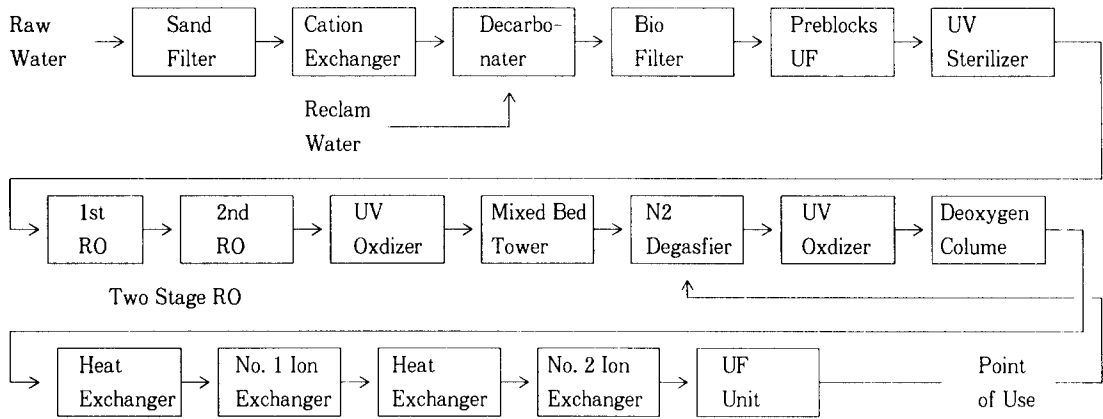

Fig. 1. Example of ultrapure water production system.

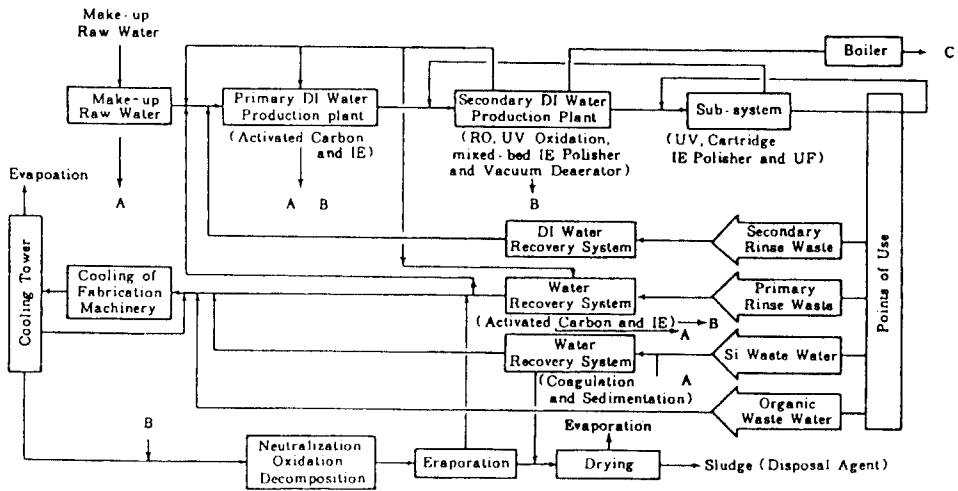

Fig. 2. Example of closed system.

2. Example of Ultra-Pure Water Producing System and Element Technologies

Figs. 1 and 2 show examples of ultra-pure water producing systems now in operation. Fig. 2 shows an example of a closed system. In order to remove various impurities in water efficiently, various units are arranged.

As element technologies used for ultra-pure water producing system, especially the membrane separation, ion exchange, ultraviolet oxidation, degas treatment, biological treatment, and technolo-

gy of piping, etc. are important. The analytic evaluation technology is a basic technology for developing such technologies and grasping the performance of a system.

3. Inherent Technologies

3. 1. Membrane Technology

Of the element technologies of the ultra-pure water producing system, the membrane technology plays a central role. As a result of the progress of the membrane technology, it can be said that the

higher purity of the ultra-pure water quality has been achieved. The present ultra-pure water system has the RO module (Reverse Osmosis) and UF module (Ultra Filtration) built in.

3. 1. 1. RO Module

The RO module is generally classified as follows, depending on the operating pressure.

- a) High-pressure module: operated at pressure of 40 kg/cm^2 or higher
- b) Medium-pressure module: operated at pressure of about 30 kg/cm^2
- c) Low-pressure module: operated at pressure of about 15 kg/cm^2
- d) Ultra-low-pressure module: operated at pressure of 10 kg/cm^2 or lower

For the ultra-pure water producing system, the low-pressure module is used. Recently, the performance of the ultra-low-pressure module has been improved and adopted for some systems.

(1) Structure of RO Module

As to the RO module, various structures have been developed, depending on the application, but the spiral type module is the mainstream. An example of the structure of the RO module is shown in Fig. 3.

Two flat membranes are bonded together like an envelope, a spacer is inserted, and the open end is connected to the water collecting pipe. These plural

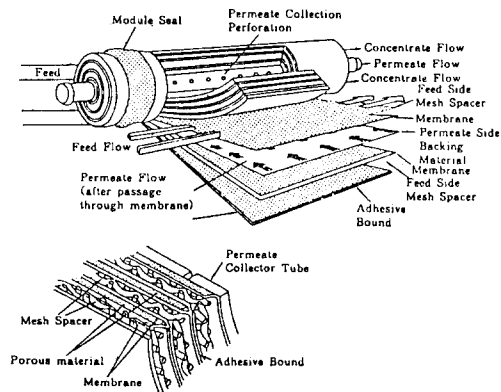

Fig. 3. Structure of spiral RO element.

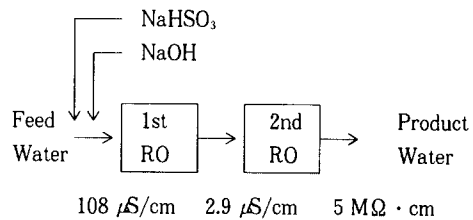

Fig. 4. Operation data of two stage RO.

sets shall be wound together with the spacer centering the water collecting pipe to be formed. These are generally called elements and, in case they are practically used, 3 to 6 pieces connected in series are used in a FRP vessel.

(2) Two-stage RO system

RO module, whose ion removing performance in a low concentration area was improved, has been developed recently. A two-stage RO system incorporating this module at the later stage has been put to practical use. Fig. 1 shows an example of an ultra-pure water producing system incorporating the two-stage RO system. The two-stage RO system can remove the ion and silica components to a level which could not be achieved with the conventional single-stage RO system. Since the water quality at the second stage greatly changes depending on pH, pH adjustment is made toward alkali. Fig. 4 shows an example of purity rise of the two-stage RO system. Fig. 5 shows the relationship between water pH and resistivity.

With this system, the resistivity of treated water is increased to $5 \text{ M}\Omega/\text{cm}$ by adjusting the water pH to 7.5. The optimum pH area differs depending on the type of RO module to be used.

3. 1. 2. UF Module

The UF module is often installed at the last stage of the ultra-pure water producing system. The UF module has the following characteristics in comparison with the RO module.

- a) Since the quantity of water transmitted per unit area is large, the equipment is compact.
- b) Since the operating pressure is low (1 to 6 kg/

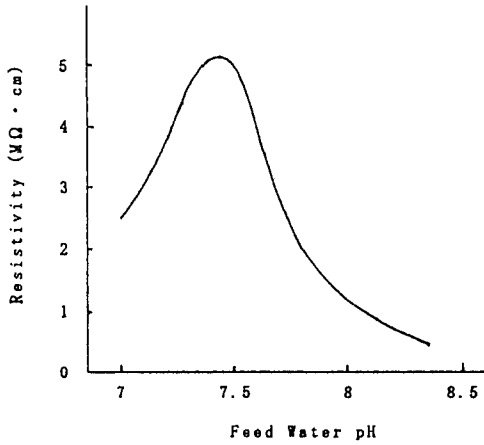

Fig. 5. Comparison of feed water pH with product water resistivity in two stage RO system.

cm²), the power consumption of the pump is less.

c) Since a high-pressure pump is not used, vibration from the pump is less and the equipment can be installed near the use point.

(1) Structure of UF module

The UF membrane is composed of a dense skin layer having a removing function and porous layer to support it, and it has an symmetrical structure or symmetrical structure. The skin layer is said to have the thickness of 0.1 to 1 μm. This layer can be considered to be thin skin of the surface produced when the solvent evaporates during manufacture.

As the UF module structure, spiral type and capilar type are available, and presently, the module used at the final stage of the ultra-pure water system is the capillary type.

The cross-sectional photograph of the UF membrane of the capillary type is shown in Fig. 6. Portion A is the skin layer, and portion B the supporting layer. This UF membrane has the skin layer at the outer periphery and inner periphery, and it is called a double skin structure. These capillary are bundled to form the module. Fig. 7 shows the sketch drawing of the capillary type module.

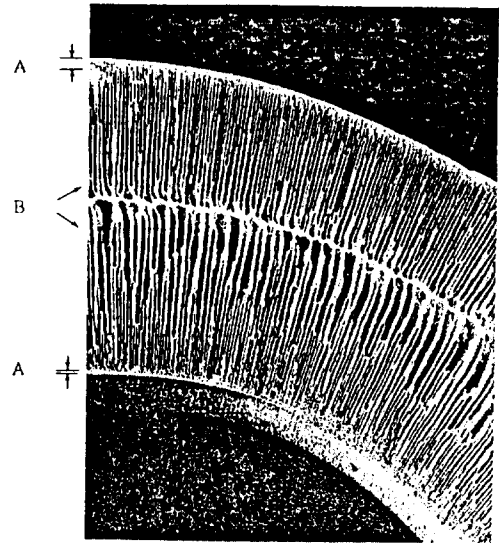

Fig. 6. Section of capillary UF (by SEM).

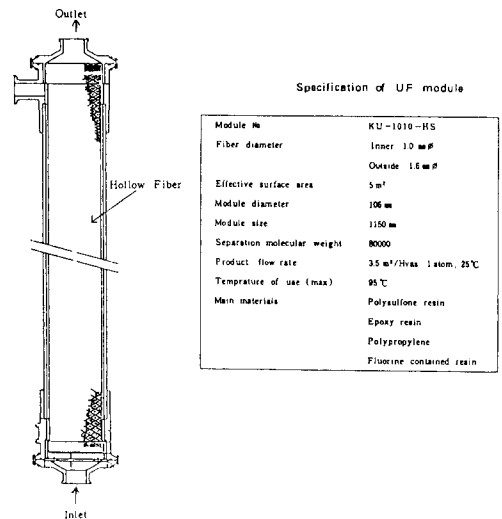

Fig. 7. Structure of capillary UF module.

(2) Required performance

The performance required of the UF module for the final filter is the following 3 items.

a) Less elution from module material

Since the UF module is installed at the final stage of the ultra-pure water producing system, the reduction in resistivity or elution of ionic substances from the membrane module components must be

minimized. It is also necessary to reduce the elution of nonionic substances and organic substances which do not appear in resistivity.

b) Less separation of particulates from membrane components

If the UF membrane which allegedly does not transmit particulates of 10 to 100 angstroms in diameter is used as the final filter, in principle, it is possible to completely remove the particulates of $0.05 \mu\text{m}$ to $0.2 \mu\text{m}$. In reality, however, particulates are present on the side of the product water. These are particulates separated from the components on the side of the product water, and it is necessary to remove them.

c) Structure should not allow liquid accumulation

If liquid accumulates in the module, it takes time for the purity to increase at the initial startup. The ultra-pure water producing system is regularly sterilized to prevent microorganism from growing in the system, but the liquid accumulation cannot be sterilized, so microorganisms grow, adversely affecting the water quality.

As the capillary type module, internal pressure type to have water transferred from inside to outside and external pressure type, the opposite, are available. As a structure with less self-dusting and without liquid accumulation, the external pressure type UF is more advantageous, and presently, most of the UF modules used at the final stage are of the external pressure type. The comparison on the number of particulates between the internal pressure type and the external pressure type is shown in Figs. 8 and 9. While the number of particulates of the internal pressure type is 2~3 number/ml 1000 hrs after the waste supply is started, the number of particulates of the external pressure type is 1 number/ml or less. To check the separation from the used members, a vibrator was installed at the center of the module and the number of particulates on the side of the transferred water was measured, and the result is shown in Fig. 10. The upper portion of the figure shows the internal pressure type and the lower portion the external pressure type.

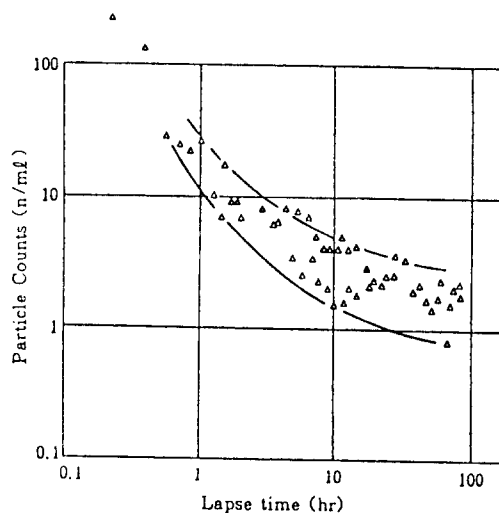

Fig. 8. Transition of particle counts(Inside pressure type UF).

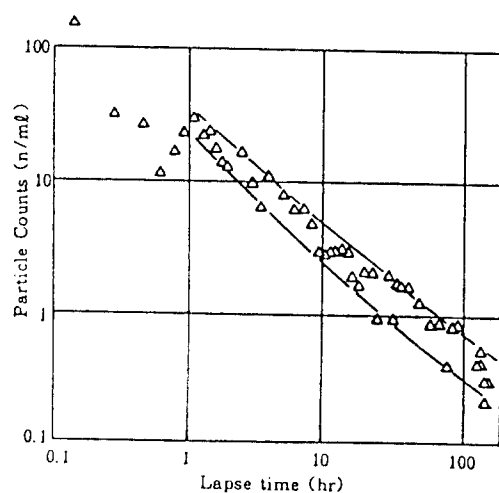

Fig. 9. Transition of particle counts(Outside pressure type UF).

The internal pressure type UF module is very weak against vibration from outside, and the number increased 100~1000-fold in comparison with the normal time. The external pressure type UF module has a very small area of treated water in contact with other members than the membrane portion, in comparison with the internal pressure type, and the particulates did not increase and stable water quality was obtained.

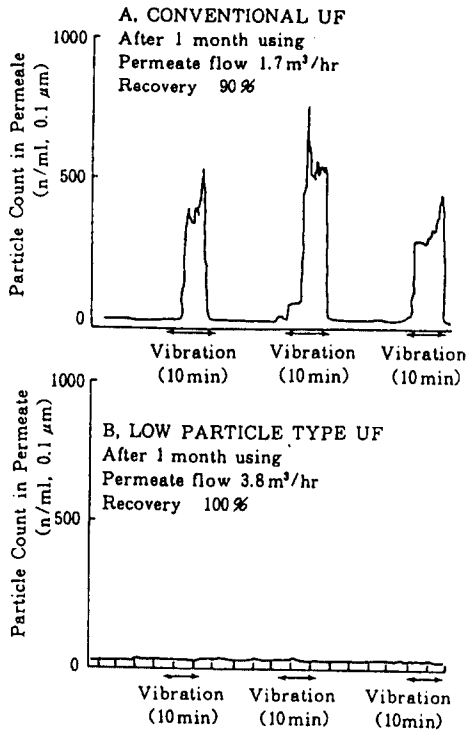

Fig. 10. Particle generation from UF element with vibration.

3. 2. TOC Decomposition Technology

As the organic substance decomposition method, the ultraviolet oxidation method, ozone oxidation method, biological decomposition method, thermal decomposition method, etc. are available, but in this paper, the ultraviolet oxidation method and biological treatment method widely used with the ultra-pure water equipment are described.

3. 2. 1. Ultraviolet Oxidation Method

This method is to decompose the organic substance by irradiating ultraviolet rays, and two types, low-pressure ultraviolet ray oxidizing equipment and high-pressure ultraviolet ray oxidizing equipment, are available.

(1) Low-pressure ultraviolet ray oxidizing equipment

This equipment is to decompose a trace of organic

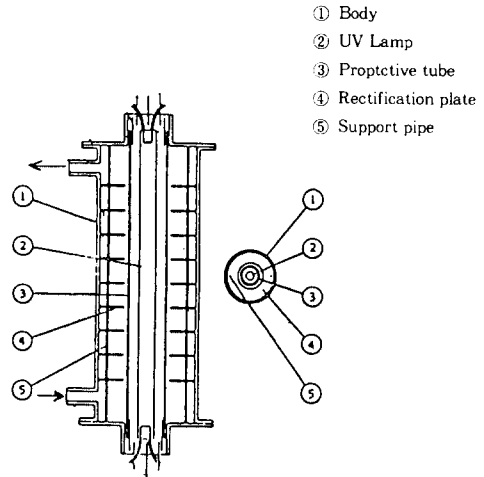
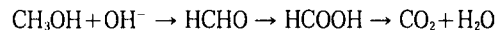
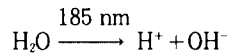

Fig. 11. Example of low pressure ultraviolet ray oxidizing equipment.

substance in water without using an oxidizing agent. Among the ultra-pure water producing units, this plays a role like that of the polishing unit and is used within the secondary demineralizer.

Its outline is shown in Fig. 11. This unit is a stainless steel cylinder and contains several low-pressure mercury lamps. The low-pressure mercury lamps are contained in a protective tube made of quartz to prevent their contact with water.

The decomposing principle of the low-pressure ultraviolet ray oxidizing equipment (L-UVox) is that the hydroxy radical (OH⁻) obtained by ultraviolet rays (wavelength 185 nm) acts as the oxidizing agent to decompose the organic substance, as shown in the following reaction formula.



Take the example of the decomposing mechanism of methanol. Finally, it is decomposed into carbon dioxide and water, but a huge amount of ultraviolet irradiation is required, so the decomposition is made to organic acid, which is adsorbed by the ion exchange resin. Fig. 12 shows an example of change

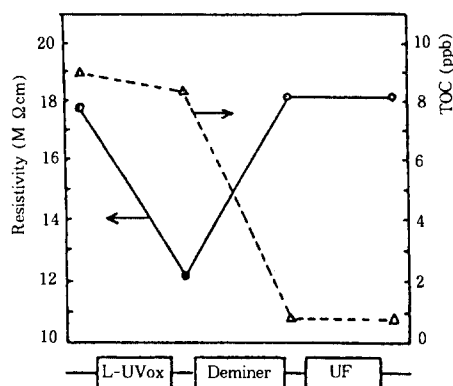

Fig. 12. Example of change in water quality in the secondary pure water production system.

in water quality in the secondary pure water producing system. There is almost no change of TOC at the outlet of the low-pressure ultraviolet ray oxidizing equipment, but from the reduction in resistivity it is known that organic acid is generated. In the nonregenerative ion exchange equipment at the later stage, organic acid is removed and the resistivity is increased and TOC is reduced.

As described above, the low-pressure ultraviolet ray oxidizing method makes it possible to treat the organic substance efficiently by means of the ultraviolet ray oxidizing equipment and ion exchange equipment.

(2) High-pressure ultraviolet ray oxidizing equipment

This equipment is suitable for decomposing organic substances of relatively high concentration and is applied to organic substance decomposition of recovered water (TOC concentration: hundreds of ppb-several ppm) in the ultra-pure water producing system. Fig. 13 shows the outline of the equipment.

This equipment uses high-pressure mercury lamps as the ultraviolet light source and decomposes organic substances in water by using in combination an oxidizing agent and the ultraviolet rays of maximum 400 nm generated from the light source. As the oxidizing agent, hydrogen peroxide is used.

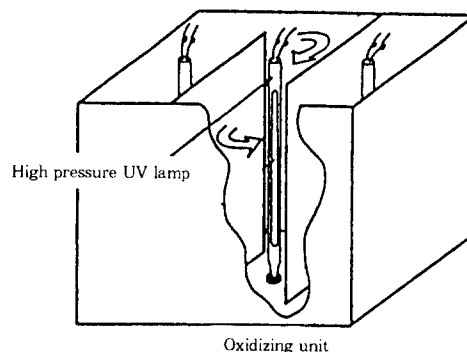

Fig. 13. High pressure ultraviolet ray oxidizing equipment.

Several high-pressure mercury lamps contained in protective tube are installed in a rectangular reaction tank (material: SUS). In the tank, partition plates are provided to increase the decomposing efficiency.

In the high-pressure ultraviolet ray oxidizing equipment, a lot of hydroxy radical is generated to decompose the organic substances by means of the hydrogen peroxide and the ultraviolet rays of 400 nm maximum, as shown below. In this decomposing method, the organic substance is decomposed and changed from organic acid to carbon dioxide. This is the same as the reaction of the low-pressure ultraviolet oxidation except that the hydrogen peroxide is used to generate a large amount of hydroxy radical.

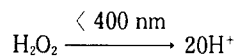

Fig. 14 shows an example of the system incorporating the high-pressure ultraviolet oxidation. The process water is treated by the ion exchange equipment, and then the remaining organic substances are treated by the high-pressure ultraviolet ray oxidizing equipment. Hydrogen peroxide is injected before the tank, and since some hydrogen peroxide remains at the outlet of the equipment, equipment to decompose it is installed at the later stage. Presently, catalyst resin (H_2O_2 decomposing resin) carrying activated charcoal or palladium (Pd) is used.

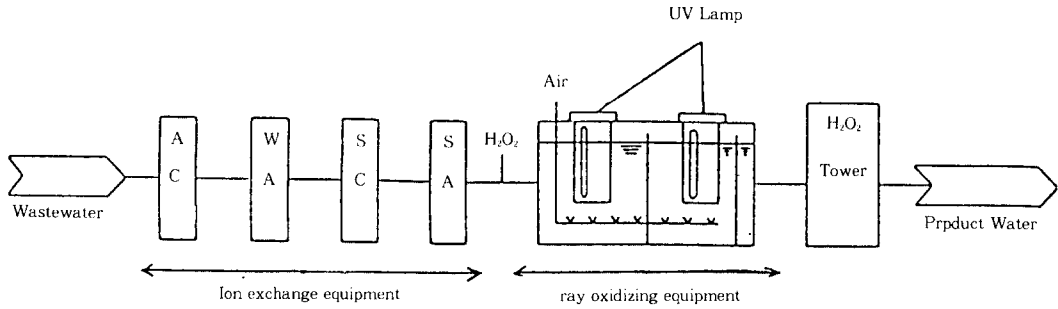

Fig. 14. Example of the system incorporating the high pressure ultraviolet ray oxidizing equipment.

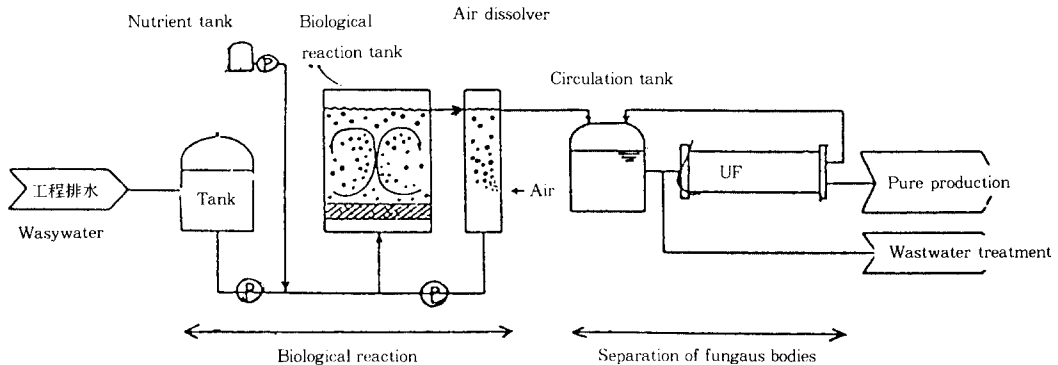

Fig. 15. Example of biological decomposing system(trade name: Biofilter & Preblock).

3. 2. 2. Biological Decomposing Method

In the field of waste water treatment, biological decomposing equipment is widely used as the method of treating organic waste water. With the ultra-pure water producing system, the biological decomposing equipment was not used in the past. The reason is that the objects to be removed for producing ultra-pure water included microorganisms and there was resistance to its growth within the system and it was considered to be inefficient for treating organic substances of low concentration.

The merits of introducing biological treatment are as follows.

- ① Economical (equipment cost and operation cost can be reduced)
- ② Reduction in installation area
- ③ Possibility of treating organic substances of high concentration (up to 10 ppm)

Presently, the biological decomposing equipment is used for treating organic substances in recovered water in place of the high-pressure ultraviolet ray oxidizing equipment. Fig. 15 shows an example of biological decomposing system (trade name: Biofilter & Preblocks). The system consists of biological decomposing portion and biomass separating portion. The features of each unit are described below.

(1) Biodegradation

Table 2 shows the results of separating/confirming the fungus bodies from actual ultra-pure water. Most of them are bacteria belonging to Pseudomonas and living bacteria are rather limited in comparison with ordinary waste water. These fungus bodies belonging to oligotrophic bacteria show a high growth rate even for the organic substances of low

Table 2. Example of Bacteria Separation from Ultra-pure Water

Kind of bacteria	Number of detect
Pseudomonas	101
Acinetobacter	16
Alcaligenes	5
Falvobacterium	5

concentration, and it is reported that they can be applied to the ultra-pure water system. The equipment consists of a raw water tank, biological reaction tank, and air dissolver, and performs circulating treatment. As nutrient salt, a trace of nitrogen and phosphorus is added.

In the biodegradation, the organic substances, nutrient source, can be easily decomposed. The waste water (recovered water) from the semiconductor process contains a lot of such biologically decomposable organic substances.

Organic substances (e. g., high polymer organic substances) which cannot be biologically decomposed are removed by other equipment (activated charcoal, RO membrane equipment, etc.) shown in Figs. 1 and 2.

(2) Separation of fungus bodies

In biodegradation, microorganisms grow in proportion to the concentration of organic substances, and fungus bodies of about 10^6 CFU/ml per TOC 1 ppm of raw water are generated. In the ultra-pure water producing system, the generation of such a large amount of fungus bodies is a major problem and the fungus bodies must be efficiently separated.

As the fungus body separating technology, the RO membrane and UF membrane are available, but they are not suitable for removing such a large amount of fungus bodies.

The separating performance is very good, but clogging in a short time makes water passage impossible. Therefore, a clogging-free membrane is required.

Fig. 16 shows the UF module (trade name: Preblocks) developed for removing fungus bodies. This

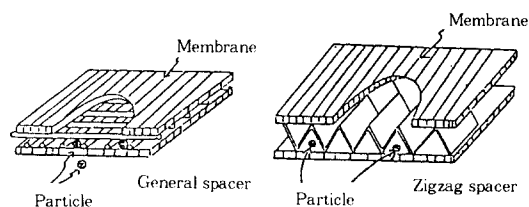
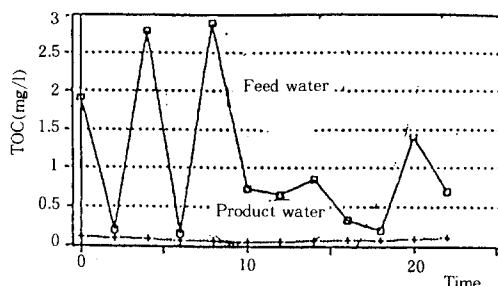
**Fig. 16.** UF module developed for removing fungus bodies (trade name: Preblocks).**Fig. 17.** Example of TOC treatment by biodegradation.

reduces clogging with fungus bodies and suspended substances in water by using a zigzag spacer for the spacer portion of the spiral type UF module, securing a sufficient passage. When raw water containing a lot of fungus bodies is passed as in the case of biodegradation, the contamination of the membrane faces cannot be avoided. With the membrane separating equipment, therefore, automatic backwashing (water is passed from membrane transmitted side to raw water side) is done regularly.

(3) Example of application to system

Fig. 17 shows an example of TOC treatment by biodegradation + UF membrane treatment. Although the concentration of the raw water (recovered water) greatly fluctuates, the treated water shows a stable quality with TOC concentration 100 ppb or less. The FI value, contamination index of water, was 1.7 for recovered water, 5.4 for biologically treated water, and 0.6 for UF treated water, and the separation of fungus bodies was good. The

Table 3. Example of Analysis of Representative Organic Substances (Many Organic Substances in Semiconductor Waste Water)

Items	Case-1		Case-2	
	Feed	Product	Feed	Product
TOC	—	—	120	65
IPA	1000	< 20	< 20	< 20
Acetone	50	< 50	< 50	< 50
Methanol	260	< 100	< 100	< 100
Ethanol	200	< 100	—	—

($\mu\text{g/l}$)

FI value is calculated by the following formula after water is filtered by the membrane filter ($0.45 \mu\text{m}$).

$$\text{FI value} = (1 - T_0/T_{15})/15 \times 100$$

T_0 : filtering time (sec) of initial 0 to 500 ml

T_{15} : filtering time (sec) of 0 to 500 ml after 15 minutes

Table 3 shows an example of analysis of representative organic substances (many organic substances contained in semiconductor waste water) with actual equipment using the head space gas chromatograph. The lower limit value differs depending on the substance, but the organic substances are well treated proving that these biodegradation units are sufficiently functioning.

(4) Behavior of TOC within ultra-pure water system

Fig. 18 shows an example of TOC behavior within the ultra-pure water system. In the figure, comparison was made between a recent system incorporating biological treatment and a system without biological treatment.

The amount of TOC decomposed by the biological treatment is hundreds of ppb, as large as the absolute amount. Subsequently, the TOC is treated by the units. Finally, it is treated to become 1 ppb or less by the low-pressure ultraviolet ray oxidizing equipment. With the system without biological treatment, the final TOC level is high.

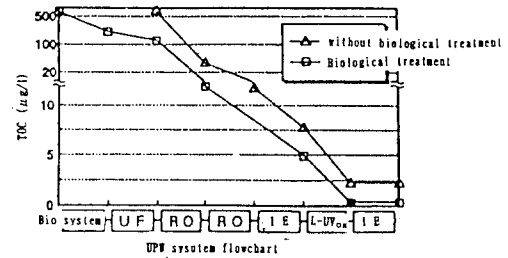

Fig. 18. Example of TOC behavior within the ultra-pure water system.

3.3. Piping Materials

The ultra-pure water piping from the ultra-pure water producing equipment to the use point is required to prevent the purity of ultra-pure water from decreasing. The ultra-pure water is produced in the utility area and sent through the main piping of several hundreds of meters to the clean room where it is subdivided into branch pipes and finally distributed to tens of use points. In such a long complicated piping system, the purity of the ultra-pure water is reduced due to various factors. As the main factors to reduce the purity, the following items can be cited.

- 1) Elution and separation of impurities from piping material
- 2) Microorganism growth in piping system
- 3) Entry of air and gas into piping system

To minimize such effects, a proper piping material with less elution is selected/used, and special consideration is given in terms of piping structure and construction. In terms of operation, the ultra-pure water piping system is designed to always circulate the water so that the water quality will not be reduced due to water stagnation.

The piping material used for ultra-pure water was PVC (Polyvinyl Chloride) in the beginning, but to cope with higher purity of the ultra-pure water, the clean PVC Pire for ultra-pure water was put to practical use in 1987. Subsequently, to cope with much higher purity and because of the adoption of a thermal sterilization method and use of warm ultra-pure water, heat-resisting piping material drew at-

Table 4. Piping Material for Ultrapure Water

	requirement
1. Chemical stability	<ul style="list-style-type: none"> ◦ Neither main component nor additives should be released into ultra pure water ◦ No deterioration with hydrogen peroxide, ozone.
2. Physical stability	<ul style="list-style-type: none"> ◦ Withstanding the water pressure in the range of 5 to 10 kg/cm²
3. Heat resistant properties	<ul style="list-style-type: none"> ◦ Having heat resistant up to 100 °C ◦ Less thermal expansion
4. Product	<ul style="list-style-type: none"> ◦ Inside surface smoothness, particle contamination should be controlled ◦ A variety of size in pipes, fittings and valves should be available
5. Cost, Fitting	<ul style="list-style-type: none"> ◦ Material cost is reasonable ◦ Pipe fitting is a easy work

tention. As the heat-resisting piping material, PVDF (Polyvinylidene Fluoride), PEEK (Polyetheretherketon), etc. are put to practical use.

3.3.1. Required Quality

Table 4 shows the properties required of the ultra-pure water piping material. As to the chemical stability, it is necessary for the main material and additive not to elute in ultra-pure water. For sterilizing the ultra-pure water system, hydrogen peroxide, oxidizing agent, or hot water is used, but the material must not be deteriorated due to these. As to the mechanical stability, it must have the strength to withstand the water pressure of 5 to 10 kg/cm², and it is desirable that deformation due to creep will not occur even after use for a long time. As to heat resistance, it must retain the mechanical strength at a high temperature, and it is important that it is chemically stable with little thermal expansion. When the linear expansion is large, long piping should be installed in such a way that the expansion of piping due to thermal expansion is absorbed.

As a product, pipes of various bore diameters and joints must be prepared. As the product quality, the quality control must be made to prevent the inner surfaces from being contaminated.

3.3.2. General Properties

Table 5 shows the structure and general properties of the materials used as the ultra-pure water piping material. For the PVC piping material, stabi-

lizer, pigment, and lubricant are added, so their elution into ultra-pure water becomes a problem. On the other hand, no additive is used for PVDF and PEEK. Since their heat-resisting temperature is high, they are widely used as the piping for ultra-pure water. PEEK is the best material, but the cost is high, so it is used as the piping for hot ultra-pure water.

3.3.3. Evaluation on Elution

As a method to measure the eluting rate and amount of impurities (ions, organic substances, etc.) eluted from the piping material, the short pipe water sealing test is conducted. Table 6 outlines the method.

This method is to seal ultra-pure water in a pipe of 25 mm in inside diameter and 1 m in length, with one end welded with the same material, let it stand for a certain period, then take out the water, and analyze the components eluted. This method was standardized by the Standardization Committee of Ultra-Clean Society in Japan and announced at the Semiconductor Pure Water and Chemical Conference in February 1996 (SPWCC '96).

Tables 7 and 8 show the results of the elution evaluation tests using the above evaluating method. with both PEEK and PVDF, the metal elution was small. Of the measurement items, the results of TOC and fluorine ion with much elution are shown in Fig. 18 and 19. It is known that the elution of TOC and fluorine ion differs depending on the type

Table 5. General Characteristics of Piping Materials

	Unit	Polyvinyl Chloride (PVC)	Polypropylene (PP)	Polyvinylidene fluoride (PVDF)	Perfluoroalkoxy vinyl ether (PFA)	Poly-ether-ether-ketone (PEEK)
Molecule structure						
Additives		Stabilizer, pigment	Oxidation inhibitor, stabilizer, pigment	None	None	None
Color		Blue	Blue	Milky white	Milky white	Light brown
Specific gravity		1.43	0.91	1.77	2.17	1.30
Strength against stretching	kg/cm ²	500~550	250	500~600	320	930
Elasticity	kg/cm ²	2.7 × 10 ⁴	1.5 × 10 ⁴	1.4 × 10 ⁴	—	4.0 × 10 ⁴
Elongation	%	50~150	400~600	200~300	280~300	150
Expansion const.	1/°C	6~8 × 10 ⁻³	11 × 10 ⁻³	12 × 10 ⁻³	12 × 10 ⁻³	5 × 10 ⁻³
Heat conductivity	kca/m · h°C	0.13	0.15~0.2	0.11	0.22	0.22
Applicable temp, limit	°C	60	100	140	260	152

Table 6. Imprisoning Test Procedure

Piping	
Size	: 25 mmφ × 1000 mmL
Test piping have three sockets, glued cap on bottom and detachable cap on top end.	
Condition	
Imprisoned liquid	: Ultrapure water 500ml
Temperature	: 25°C, 80°C
Period	: 1, 7 and 30 days
Analysis	
Ion · chromatography (Na, K, F, Cl, SO ₄ , PO ₄ , NO ₃)	
Flameless AA (Fe, Cu, Zn, Ni, Sn, Ca, Mg)	

of piping. Eventually, the elution decreases for all and no difference is recognized among the pipings, but just after the installation, the elution amount is large. In comparison with the ordinary-temperature

system, the elution is more in hot ultra-pure water (80°C) suggesting that the selection of piping material is important.

3.3.4. Effect of Elution from Piping on Quality of Ultra-Pure Water

On the basis of the results in Tables 7 and 8, the degree of effect on water quality with actual piping was calculated. The results are shown in Table 9. The calculation result of TOC reveals that the effect in ordinary-temperature water is very small, but at 80°C, the effect remains for about one month. It is also known that the effect varies slightly depending on the type of piping.

As to the fluorine ion, the elution is very small at the ordinary temperature, but at 80°C, it increases and affects the resistivity even after the elapse of one month after the start of water supply.

Table 7. Imprisoning Test in PEEK and PVDF Pipe (Tem. 20°C)

Items	Period (Days)	PEEK		PVDF(A)		PVDF(B)	
		Mean Concentration(ppb)	Release ($\mu\text{g}/\text{m}^2 \cdot \text{Day}$)	Mean Concentration(ppb)	Release ($\mu\text{g}/\text{m}^2 \cdot \text{Day}$)	Mean Concentration(ppb)	Release ($\mu\text{g}/\text{m}^2 \cdot \text{Day}$)
TOC	~ 1	15.5	58	36.3	186	23.2	105
	2~ 7	14.5	8.6	77.0	72	40.4	35
	8~30	19.0	3.4	124	31	44.7	10
Silica	~ 1	< 5	<31	< 5	< 31	< 5	< 31
	2~ 7	< 5	< 5.1	< 5	< 5.1	< 5	< 5.1
	8~30	< 5	< 1.3	< 5	< 1.3	< 5	< 1.3
Na	~ 1	0.1	0.6	0.2	1.2	< 0.1	< 0.6
	2~ 7	0.2	0.2	0.2	0.2	< 0.1	< 0.1
	8~30	< 0.1	< 0.03	< 0.1	< 0.03	< 0.1	< 0.03
K	~ 1	0.4	2.5	< 0.2	< 1.2	< 0.2	< 0.6
	2~ 7	0.3	0.3	0.3	0.3	< 0.2	< 0.1
	8~30	0.2	0.05	0.3	0.08	0.2	< 0.03
Mg	~ 1	< 0.4	< 2.5	0.4	2.5	< 0.4	< 1.2
	2~ 7	< 0.4	< 0.4	< 0.4	< 0.4	< 0.4	< 0.2
	8~30	< 0.4	< 0.11	< 0.4	< 0.11	< 0.4	0.05
Ca	~ 1	< 0.5	< 3.1	< 0.5	< 3.1	< 0.5	< 2.5
	2~ 7	< 0.5	< 0.5	< 0.5	< 0.5	< 0.5	< 0.4
	8~30	< 0.5	< 0.13	< 0.5	< 0.13	< 0.5	< 0.11
Fe	~ 1	< 0.5	< 3.1	< 0.5	< 3.1	< 0.5	< 3.1
	2~ 7	< 0.5	< 0.5	< 0.5	< 0.5	< 0.5	< 0.5
	8~30	< 0.5	< 0.13	< 0.5	< 0.13	< 0.5	< 0.13
Sn	~ 1	< 5	<31	< 5	< 31	< 5	< 31
	2~ 7	< 5	< 5	< 5	< 5	< 5	< 5.1
	8~30	< 5	< 1.3	< 5	< 1.3	< 5	< 1.3
Cl ⁻	~ 1	0.8	4.9	0.9	5.5	1.0	6.1
	2~ 7	< 0.5	< 0.5	0.5	0.5	< 0.5	< 0.5
	8~30	< 0.5	< 0.13	< 0.5	< 0.13	< 0.5	< 0.13
F ⁻	~ 1	<10	<61	11	67	26	159
	2~ 7	<10	<10	40	41	74	76
	8~30	<10	< 2.7	107	29	150	40

Table 8. Imprisoning Test in PEEK and PVDF Pipe (Tem. 80°C)

Items	Period (Days)	PEEK		PVDF(A)		PVDF(B)	
		Mean Concentration(ppb)	Release ($\mu\text{g}/\text{m}^2 \cdot \text{Day}$)	Mean Concentration(ppb)	Release ($\mu\text{g}/\text{m}^2 \cdot \text{Day}$)	Mean Concentration(ppb)	Release ($\mu\text{g}/\text{m}^2 \cdot \text{Day}$)
TOC	~ 1	43.5	226	1370	8360	329	1980
	2~ 7	88.2	86	3070	3130	645	654
	8~30	89.0	22	4770	1270	978	259
Silica	~ 1	< 5	< 31	< 5	< 31	< 5	< 31
	2~ 7	< 5	< 5.1	< 5	< 5.1	< 5	< 5.1
	8~30	< 5	< 1.3	< 5	< 1.3	< 5	< 1.3
Na	~ 1	0.2	1.2	0.3	1.8	0.9	5.5
	2~ 7	0.4	0.4	0.3	0.3	0.4	0.4
	8~30	< 0.9	0.24	0.4	0.11	0.5	0.13
K	~ 1	< 0.2	< 1.2	0.5	3.1	< 0.2	< 1.2
	2~ 7	0.4	0.4	2.5	2.6	1.1	1.1
	8~30	0.5	0.13	0.4	0.11	0.5	0.13
Mg	~ 1	< 0.4	< 2.5	< 0.4	< 2.5	< 0.4	< 1.2
	2~ 7	< 0.4	< 0.4	< 0.4	< 0.4	< 0.4	< 0.4
	8~30	< 0.4	< 0.11	< 0.4	< 0.11	< 0.4	0.11
Ca	~ 1	< 0.5	< 3.1	< 0.5	< 3.1	< 0.5	< 3.1
	2~ 7	< 0.5	< 0.5	< 0.5	< 0.5	< 0.5	< 0.5
	8~30	< 0.5	< 0.13	< 0.5	< 0.13	< 0.5	< 0.13
Fe	~ 1	< 0.5	< 3.1	< 0.5	< 3.1	< 0.5	< 3.1
	2~ 7	< 0.5	< 0.5	0.7	7.2	0.7	0.7
	8~30	< 0.5	< 0.13	< 0.5	< 0.13	< 0.5	< 0.13
Sn	~ 1	< 5	< 31	< 5	< 31	< 5	< 31
	2~ 7	< 5	< 5	< 5	< 5.1	< 5	< 5.1
	8~30	< 5	< 1.3	< 5	< 1.3	< 5	< 1.3
Cl ⁻	~ 1	4.4	27	4.1	25	3.9	24
	2~ 7	< 0.5	< 0.5	< 0.5	< 0.5	< 0.5	< 0.5
	8~30	< 0.5	< 0.13	< 0.5	< 0.13	< 0.5	< 0.13
F ⁻	~ 1	<10	< 61	407	2.5×10^3	413	2.5×10^3
	2~ 7	<10	< 10	1300	1.3×10^3	1200	1.2×10^3
	8~30	<10	< 2.7	1400	373	600	160

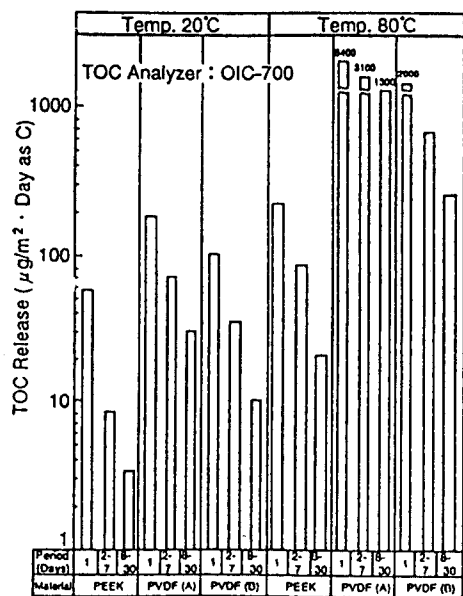

Fig. 19. Imprisoning test in PEEK and PVDF pipe (TOC).

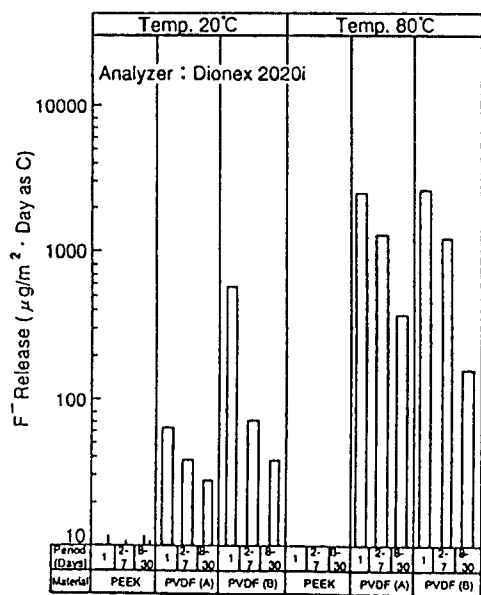

Fig. 20. Imprisoning test in PEEK and PVDF pipe (F).

Table 9. Effect of Elution from Piping on Quality of Ultrapure Water

	Temp (°C)	Period (Days)	PEEK	PVDF (A)	PVDF (B)
TOC	25	~ 1	0.06	0.2	0.12
		2~ 7	0.01	0.08	0.04
		8~30	0.004	0.03	0.01
	80	~ 1	0.25	9.3	2.2
		2~ 7	0.1	3.5	0.7
		8~30	0.02	1.4	0.3
F ⁻	25	~ 1	<0.07	0.07	0.2
		2~ 7	<0.01	0.05	0.08
		8~30	<0.003	0.03	0.04
	80	~ 1	<0.07	2.8	2.8
		2~ 7	<0.01	1.4	1.3
		8~30	<0.003	0.4	0.2

Pipe size 25 mm
 Pipe length 600 m
 Flowrate 1 m/sec

4. Conclusion

For ultra-pure water, the removal of various impurities is required, and the requirement level is rising year by year. To cope with this problem, various removing technologies and system technologies have been developed and the introduction of new materials for the piping, etc. to form the system have been positively made.

For the element technologies to be used for ultra-pure water production, their range will be expanded from the technological and economic viewpoints.

Therefore, it is absolutely necessary to develop trace analysis evaluation technologies for ultra-pure water. Especially to raise the analytical level of heavy metals and organic substances is important. It is also important to establish individual analysis methods of organic substances. It is expected that the analytical methods will be established and new treating methods will be put to practical use in the near future.

5. Reference

1. P. A. McCnnelee, S. J. Porier, R. Hanselka, Proceedings for Fifthannual, Semiconductor Pure Water Conference, San Francisco, p 219, 1986.
2. Isikawa, Ultraclean Technology Handbook Vol. 1. Ultrapure Water, Riaraiizu.
3. Yamakoshi, TOC Removal Equipment. Pioing and Equipment.
4. Sibata, Technology of Manufactuaering Water, Vol. 18. No. 3, p 56-60, 1992.
5. Motomura, Proceeding for Semiconductor Pure Water and Chemical Conference, 1995.