

Experimental Study on Strengthening Transverse Joints between Precast Concrete Slabs

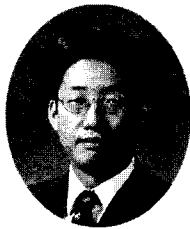

Park, Jong-Jin*



Cheung, Jin-Hwan **



Shin, Su-Bong***

Abstract

Precast R.C. slabs are being used widely for the construction of bridge structures due to their simplicity in construction processes. However, one of the disadvantages in precast R.C. slabs is the existence of transverse joints between two precast slabs. The transverse joints are structurally fragile and the task of strengthening the joints is difficult one due to their structural discontinuity. The aim of this study was to improve the behavior of transverse joints between precast R.C. slabs by introducing prestress with external cables. Three steel-concrete composite bridge specimens, which were prestressed with the external cables anchored on steel girders, were fabricated in the laboratory. Both pre-tension and post-tension methods were applied to introduce prestressing on the concrete slab with a straight tendon arrangement. Static tests were conducted at service load and ultimate load test was performed to evaluate punching shear capacity of the transverse joint. In this paper, two prestressing methods were tested and their effects were evaluated with respect to the elastic behavior and ultimate loading capacity of the transverse joints.

Keywords : precast R.C. slabs, prestress, external cables, pre-tension, post-tension, ultimate loading capacity

* KCI Member, Research Fellow, Dept. of Civil Engineering, Dong-A University, Korea

** KCI Member, Professor, Dept. of Civil Engineering, Pusan National University, Korea

*** Associate Professor, Dept. of Civil Engineering, Dong-A University, Korea

1. Introduction

Precast concrete slab is a pre-fabricated transverse floor which is often adopted to reduce the construction cost and period. An application of the precast concrete slabs is shown in Fig. 1.

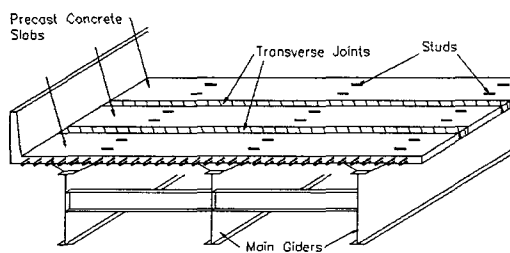

Fig. 1 Usage of precast concrete slab

In order to enhance durability of the precast slab, development of cracks have to be controlled, especially at the joints where damages are concentrated⁽¹⁾. By preventing the transverse cracks, continuity of the slab in the longitudinal direction can be maintained. Continuity of the precast slabs through the transverse joints would greatly enhance durability of the slabs. A common method of strengthening the transverse joints is by introducing prestress on the precast slabs through the transverse joints. Prestressing the precast concrete slabs in the longitudinal direction is somewhat difficult because of the existence of transverse joints between two precast slabs. Usage of the internal cables for applying longitudinal prestress is not practical because future replacements of the precast slabs can not be performed without the removal of internal cables.

The external prestressing, previously used for strengthening the existing bridges, may be applied to new bridge structures, especially where precast concrete slabs are used^(2,3). Advantages of the external prestressing are as follow;

(1) cross sectional area of concrete structures

may be decreased if internal tendons are not used,

- (2) partial repair of the structures can be easily performed by removing the prestressing force, and
- (3) overall quality can be improved because casting of concrete and introduction of prestress are independent and worked in separate operations.

Most of the study on the transverse joints have been limited to ultimate loading test conducted on the beam specimens^(4,5,6). In this paper, two applicable methods for prestressing the slabs with external cables were introduced. The tests were conducted on the steel-concrete composite structure constructed with precast concrete slabs. Static tests at service load and ultimate load were applied to study the elastic behavior and ultimate loading capacity of the transverse joints.

2. Test Specimens

2.1 Method of Prestress

Two applicable methods for introducing prestress on the precast concrete slab with external cables are described in Figs. 2 and 3.

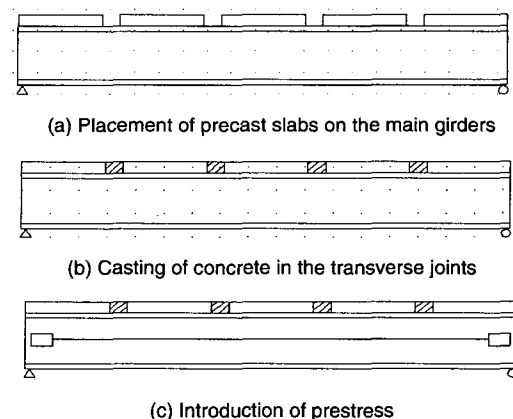

Fig. 2 Post-Tension method

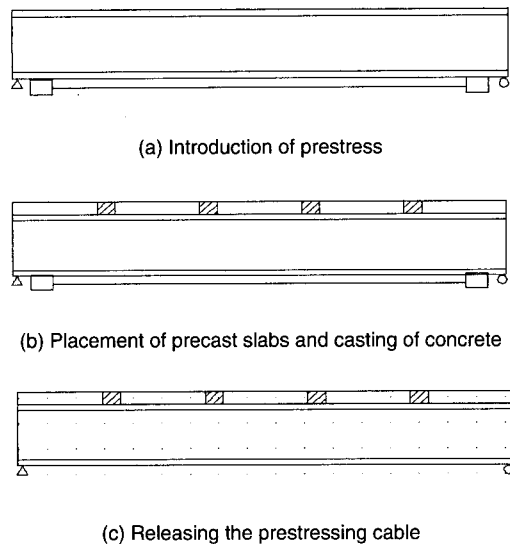

Fig. 3 Pre-Tension method

Post-tension method was applied in the following order;

- (1) installation of precast slabs on the support girders,
- (2) casting of concrete in the transverse joints between the precast slabs, and
- (3) prestressing the cables after curing the concrete in the transverse joints.

The construction can be finished in three simple steps and the construction period can also be reduced because of its simplicity.

Pre-tension method provides pre-flex to the girders before the placement of slabs as shown in Fig. 3. By giving a large eccentricity of cable position on the girder, a large amount of pre-flex can be given with a minimum cable force. Pre-tension method was performed in the following order;

- (1) introduction of prestress,
- (2) placement of precast slabs and casting of concrete in the transverse joints, and
- (3) release of the prestressing cables.

Due to the moment restoration capacity of the girders, even a small amount of prestress applied

with pre-tension method causes a large amount of compressional force in the slab. The location of the external cables is usually under the lower flange of girders. Greater the eccentricity of the prestressing cables, less tensile force is needed to introduce prestress on the slab.

2.2 Construction of Specimens

The test specimens prestressed by both post-tension and pre-tension methods are shown in Fig. 4. The position of the external cables for the post-tension was at the web 203 mm from the bottom of the steel girder and 52 mm below the bottom flange for pre-tension method. The size of the precast concrete slab was 140cm in width, 45cm in length, and 6cm in thickness. The precast concrete slabs for all test specimens were fabricated approximately a month prior to the assembly of each specimen. Prestress on the slab in the transverse direction was not introduced to isolate the effect of longitudinal prestress.

The same steel girders were used for all three specimens. The 16 mm bolts were used as the shear connector so that replacement of the precast concrete slabs could be accommodated. Holes around each bolt were grouted in order to restrict motion of the bolts and to make composite structure of girders and slabs. Concrete was filled in the joints between precast concrete slabs and was cured properly.

The size of the specimens were about 1/6 model of a commonly used bridge structure in length of 30m. The results of the compressive strength test for the concrete used in the test specimens are shown in Table 1.

The longitudinal reinforcements for every precast slabs were connected at the joints by the Lap-Joint method, which is very simple in its form⁽⁷⁾. The type of the transverse joint is shown in Fig. 5. Expansive concrete was filled in the joints between precast concrete slabs.

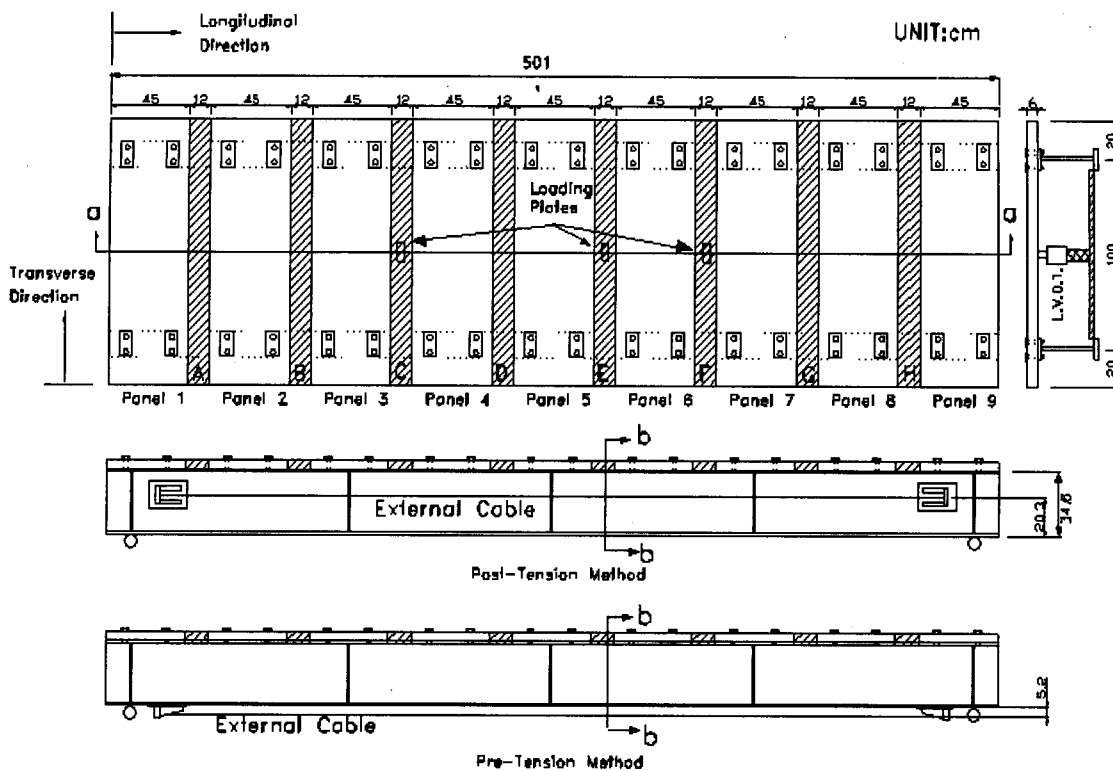

Fig. 4 The test specimens

Table 1 Properties of precast slabs

Specimens		Compressive Strength (kgf/cm ²)	Modulus of Elasticity (kgf/cm ²)
1	Precast Slab	373	2.65 x 10 ⁵
	Transverse Joint	349	2.88 x 10 ⁵
2	Precast Slab	288	3.42 x 10 ⁵
	Transverse Joint	321	2.72 x 10 ⁵
3	Precast Slab	430	3.15 x 10 ⁵
	Transverse Joint	302	3.21 x 10 ⁵

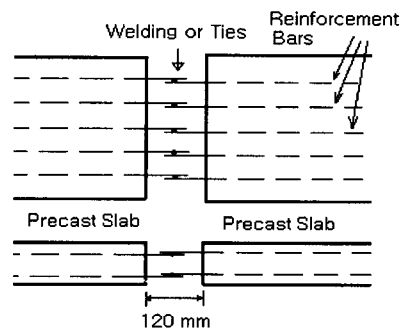

Fig. 5 Connection of longitudinal reinforcement

The test results were summarized for two types of loading cases. First, each test specimen was monotonically loaded up to the service load of 1000 kgf. The service load was applied on the transverse joints E in a prestressed condition while the joint F was loaded without the prestress.

Ultimate loading test was also performed on the transverse joints C and E in order to evaluate punch shear capacity of the concrete slab at the joint. A loading on the joint C was applied to a prestressed condition while the joint E was loaded without the effect of prestress for the ultimate load test. All loadings were applied on the specimens using 4 cm x 10 cm plate.

3. Test Results

3.1 Introduction of Prestress

Prestress on the specimens 1 and 2 was introduced by post-tension method with a total of 4 cables (2 on each girder) while prestress on the specimen 3 was introduced by pre-tension method with 2 cables (1 on each girder). Prestresses on all specimens were applied with symmetric cable arrangements. Table 2 shows the method and amount of prestress introduced

for each test specimen. Fig. 6 also shows the values of the strain due to the prestress on the composite sections of the slabs and girders. Measurement of the strain was taken along the section b-b through the transverse joint E. Specific location of the section b-b is illustrated in Fig. 4.

The measured strains are compared with theoretical quantity obtained using the beam theory in Fig. 6. The measured strains were in a good agreement with the theoretical values. Post-tension method yielded a higher compression on the bottom surface than the top surface of the concrete slab. Reversely, pre-tension method resulted in a higher compression on the top surface of the slab. The bottom surface of the concrete was subjected to a small amount of strain when the pre-tension method was used.

A disadvantage of prestressing with external cables was that a high level of prestress could not be introduced on the slab because large anchors

Table 2 Method and amount of prestress

Specimens	Prestressing Method	Calculated Amount of Prestress on the Concrete Slab (kgf/cm ²)			Measured Amount of Prestress on the Concrete Slab (kgf/cm ²)		
		Top Surface	Bottom Surface	Average	Top Surface	Bottom Surface	Average
1	Post-Tension	8	12	10	7.6	12.2	9.9
2	Post-Tension	12	18	15	12.2	18.5	15.4
3	Pre-Tension	17.5	2.5	10	16.8	3.4	10.1

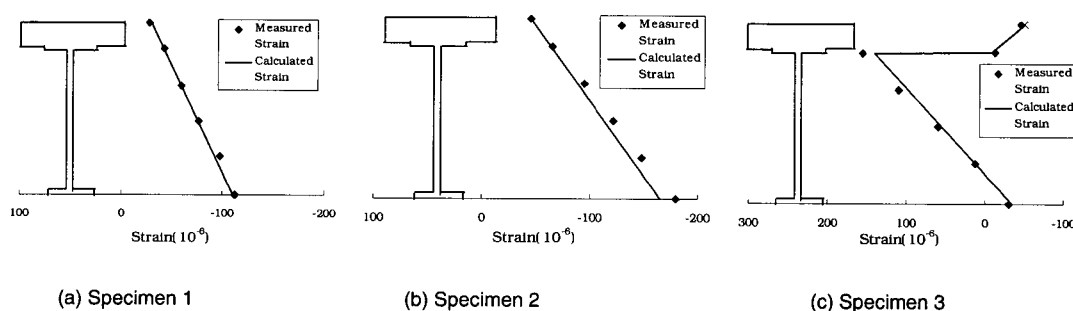
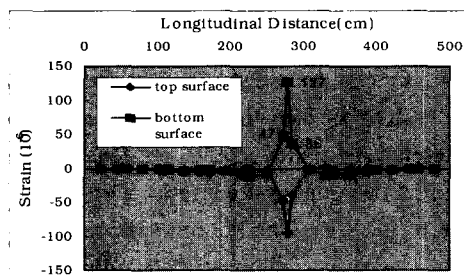

Fig. 6 Strain distributions of the composite sections due to prestress

had to be attached to the girders in order to withstand high tension of the external cables. The number of cables that could be attached to each girder was also limited. Based on the capacity of the anchors which sustain tension of the external cables, only 10 ~ 15 kgf/cm² of prestress were applied on the precast concrete slabs.

3.2 Static Test at Service Load

The strain distributions for all specimens along the section a~a when the loadings applied on the joints E and F are shown in Fig. 7. Maximum tensile strain values and strain values at the interfaces of the precast slab and transverse joint near the loading are also shown in the figure. The



(a) Specimen 1 - loading on joint E with prestress

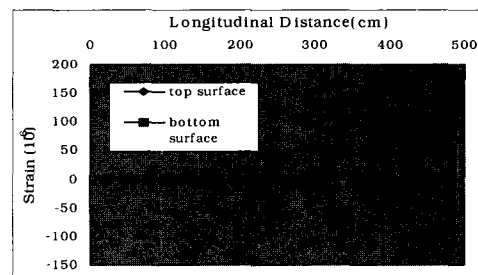

(b) Specimen 1 - loading on joint F without prestress

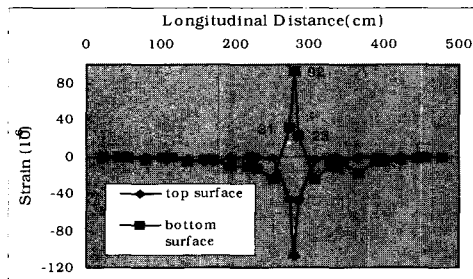

(c) Specimen 2 - loading on joint E with prestress

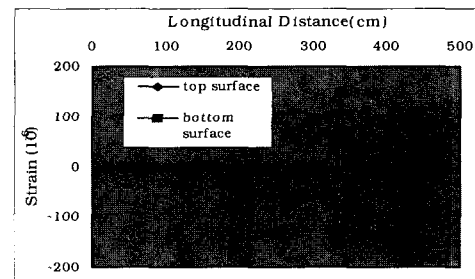

(d) Specimen 2 - loading on joint F without prestress

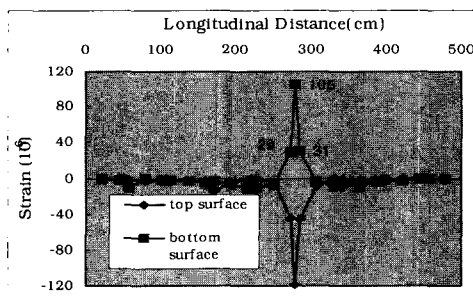

(e) Specimen 3 - loading on joint E with prestress

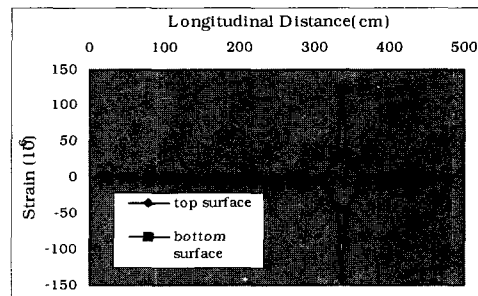

(f) Specimen 3 - loading on joint F without prestress

Fig. 7 Longitudinal strain distributions of concrete slabs due to the service load

Table 3 Strain ratio

Specimens	Specimen Conditions/ Loading Position	Maximum Strain (10^{-6})	Ratio of Maximum Strain	Average Strain at interface (10^{-6})	Ratio of Strain at the interface
1	Prestressed/ Joint E	127	1.12	41.5	1.18
	Non-Prestressed/ Joint F	142		49	
2	Prestressed/ Joint E	92	1.61	27	1.79
	Non-Prestressed/ Joint F	148		48.5	
3	Prestressed/ Joint E	105	1.16	30	1.02
	Non-Prestressed/ Joint F	122		29.5	

tensile strain for the prestressed specimens shows lower values than those of the specimens without the effect of prestress. This is to indicate the effectiveness of prestress.

Table 3 shows increase in the rigidity of the transverse joints due to introduction of prestress. Increase in the rigidity was quantified by two ratios composed of the maximum tensile strain values and strain at the interface. The ratios were obtained through division of the strains from the loading on the joint F by those of the loading on the joint E. The specimen 2, whose average prestress on the concrete slab was 15 kgf/cm^2 , showed the highest ratio of 1.61 and 1.79 while the specimens 1 and 3 showed much less in their respective ratios. This indicated that 15 kgf/cm^2 of prestress introduced in the specimen 2 was more effective than 10 kgf/cm^2 prestress for increasing the rigidity of the transverse joints.

3.3 Ultimate Loading Test

Three specimens were also tested until their ultimate strength of the transverse joints were obtained. The transverse joint of the concrete slab failed in punching shear like the case of

reinforced concrete slab⁽⁸⁾. Punching shear capacity of the concrete slab has a significance, because it influences the fatigue strength of the concrete slab. The fatigue strength of the concrete slab can be obtained as⁽⁸⁾;

$$\log(Q/P) = -0.07835 \log N + \log C \quad (1)$$

where,

Q: applied load,

P: punching shear capacity of the concrete slab,

N: number of loading cycles which can be applied on the slab, and

C: a constant.

Eq. (1) clearly implies that the fatigue strength of the concrete slab increases as the punching shear capacity (P) is enhanced.

The measured capacity of the concrete slab when the loading is applied on the transverse joint is compared with the estimated values provided by Abul and Matsui^(9,10). Abul suggests the estimation of the punching shear capacity as follows⁽⁹⁾;

$$P = 0.332\sqrt{f_c'} b_o d \quad (2)$$

$$b_o = 2(a + b) + 6.93d \quad (3)$$

where,

f_c' : compressive strength of concrete (N/mm²),

a, b : size of loading plate(cm), and

d : effective depth of concrete slab(cm).

Assumed failure line for Eq. (2) is schematically shown in Fig. 8. The failure line is assumed to be 30° and the location of the neutral axis is at the center of slab depth. Section of the slab below the neutral axis, where tensile stress is working, does not provide resistance against punching shear.

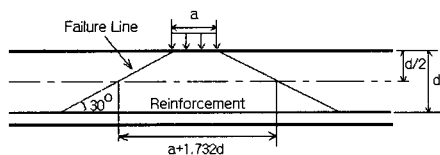

Fig. 8 Assumed failure lines for Eq.(2)

Matsui suggested the punching shear capacity of the slab as follows⁽¹⁰⁾;

$$P = \tau_s(2(a + 2X_m)X_d + 2(b + 2X_d)X_m) + f_t(2(a + 2d_m)C_d + 2(b + 2d_d + 4C_d)C_m) \quad (4)$$

where,

τ_s : shear strength of concrete (kgf/cm²),

f_t : tensile strength of concrete (kgf/cm²),

a, b : size of loading plate (cm),

X_m, X_d : depth of neutral axis for transverse and longitudinal sections of concrete slab (cm),

C_m, C_d : cover for transverse and longitudinal tension reinforcements (cm), and

d_m, d_d : effective depth of concrete slab for transverse and longitudinal sections of concrete slab (cm).

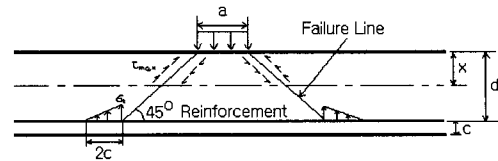

Fig. 9 Assumed failure lines for Eq.(4)

Assumed failure line for Eq. (4) is illustrated in Fig. 9. The failure line is assumed to be 45° . The section of the slab below the neutral axis, where tensile stress is working, does not provide resistance against shear. However, vertical tensile stress of the slab acting on the steel reinforcement is considered as a factor resisting the punching shear⁽¹¹⁾.

The difference between measured and calculated capacity, shown in Table 4, is due to the support conditions. Matsui and Abul's equations were based on the concrete slab simply supported on four sides^(9,10), where as the test specimens were supported by two stiff girders along the longitudinal direction. Because of the existence of stiff girders, compressive stress on the slab in the transverse direction was induced as a result of arch action. It was found from the F.E.M. analysis that average compressive stress in the transverse direction for the applied load of 10 tonf was approximately 45 kgf/cm².

Fig. 10 shows the failure of the concrete slab when the loading is applied on the transverse joints with and without prestress. The failure for both cases occurred at approximately 45° in the transverse direction while the failure in the longitudinal direction occurred along the slope of 30° . Even though the transverse Joint C was tested with prestress, the Joint C failed similarly as the other joint tested without prestress.

Table 4 shows increase in ultimate capacity when prestress is introduced. When 10 kgf/cm² of prestress was applied using post-tension method to the specimen 1, the ultimate capacity

of the concrete slab slightly increased. On the other hand, when 15 kgf/cm² of prestress was introduced using post-tension method to the specimen 2, a significantly increase in the ultimate capacity of the concrete slab was observed. Pre-tension method applied for the specimen 3 also enhanced the ultimate bearing capacity of the transverse joints against punching shear failure.

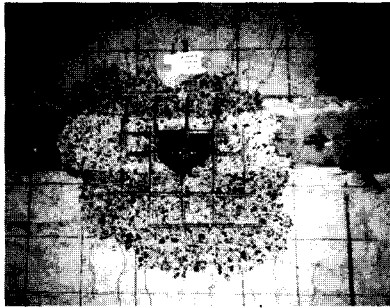

Fig. 10 (a) Failure of joint c - loaded with prestress

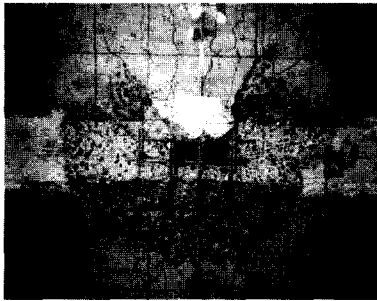

Fig. 10 (b) Failure of joint f - loaded without prestress

Eqs. (2) and (4) provide estimations for the punching shear capacity of concrete slabs without effect of prestress. Estimations may be used to calculate punching shear capacity of the slab in an ideal condition. However, other slabs which are supported by the complicated bearing conditions may not be estimated using the experimental equations. A Higher estimation given by Matsui is likely to be due to tensile stress acting on the steel reinforcement.

4. Conclusions

Behavior of the transverse joints between the precast concrete slabs can be improved by introducing the prestress with external cables. In this study, both pre-tension and post-tension methods were applied and the effects of prestress on the elastic behavior and ultimate strength of the transverse joints were evaluated.

The results can be summarized;

- 1) amount of prestress on the transverse joints can be calculated based on the tension of the prestressing cables,
- 2) prestress reduces strain on the transverse joints when the specimens are subjected to the service load,
- 3) ultimate strength of the transverse joint can be improved with introduction of prestress on the slab, and

Table 4 Punching shear capacity of concrete slab

Specimens	Loading Position	Ultimate Capacity (Measured)	Ultimate Capacity (Abul)	Ultimate Capacity (Matsui)
1	Joint C (Prestressed)	109.9 KN	65.3 KN	82.3 KN
	Joint F (Non-Prestressed)	109.6 KN		
2	Joint C (Prestressed)	109.6 KN	65.5 KN	81.1 KN
	Joint F (Non-Prestressed)	106.0 KN		
3	Joint C (Prestressed)	114.7 KN	70.7 KN	85.1 KN
	Joint F (Non-Prestressed)	111.6 KN		

- 4) Experimental equations may not provide accurate estimations of the punching shear capacity for concrete slab.

Acknowledgement

This work was supported by the Brain Korea 21 project.

References

1. Kim, Y., Matsui, S., and Keizo, E., "Prestressing Method and Shearing Strength of Slab Joints for Precast Slabs on Continuous Steel Girder Bridges," Proceedings of JSBM 98, Osaka, Osaka University, Vol.3, 362-363.
2. Yatsuzuka, H., Kashiwagi, R., Yamada, K., and Natori, T. (1996). "Strengthening of Existing Plate Girder Bridges by Prestressing Tendons." J. of Bridge and Foundation Engineering, Vol. 30, No. 3, 1996, pp.15-24.
3. Li, W., Albrecht, P., and Saadatmanesh, H. (1995) "Strengthening of Composite Steel-Concrete Bridges." J. of Structural Engineering, Vol. 121, No. 12, pp.1842-1849.
4. Chung, C., H., Kim, Y., J., Kim, S., W., and Park., C., L. (1998). "Static Tests on Transverse Joints of Precast Prestressed Concrete Bridge Deck." J. of the Korea Concrete Institute, Vol. 10, No. 2, pp.109-117.
5. Kim, Y., J., Chung, C., H., and Shim, C., S., (1998). "A Study on Bond Properties of Joint Grouting Materials for Precast Concrete Bridge Decks." J. of the Korea Concrete Institute, Vol. 10, No. 1, pp.153-160.
6. Kim, Y., J., Chung, C., H., and Kim, J., H., (1998). "Shear Test on Female-to-Female Type Joint between Precast Concrete Bridge Decks." J. of the Korea Concrete Institute, Vol. 10, No. 6, pp.161-168.
7. Nagai, H., (1988) Design of Composite Bridge Structures Using Precast Concrete Slabs, Morikita, Tokyo, Japan.
8. Matsui, S., "Technology Development for Bridge Deck - Innovations on Durability and Construction -." J. of Bridge and Foundation Engineering, Vol. 31, No. 8, 1997, pp.84-94.
9. Abul, A., Mohammed, B., Mohammed A., and Kaiser, K., "Punching Shear Capacity of Deck Slabs in Girder-Slab Bridges," ACI Structural Journal, Vol. 91, No. 6, Nov.-Dec., 1994, pp. 656-662.
10. Matsui, S., "Fatigue Strength of Concrete Slab for Bridge Structures," Ph.D. Thesis, Osaka University, 1984.
11. Ota, H., Matsui, S., Higashiyama, H., and Park, J., J., "Behavior of PCa-RC slab Prestressed by External Cables." Proc, 52th Annual Conference, Nagoya, JSCE, Vol.52, 362-363.