

Low Level Control of Metal Belt CVT Considering Shift Dynamics and Ratio Valve On-Off Characteristics

Talchol Kim, Hyunsoo Kim*

Department of Mechanical Design Engineering, Sungkyunkwan University

In this paper, low level control algorithms of a metal belt CVT are suggested. A feedforward PID control algorithm is adopted for line pressure based on a steady state relationship between the input duty and the line pressure. Experimental results show that feedforward PID control of the line pressure guarantees a fast response while reducing the pressure undershoot which may result in belt slip. For ratio control, a fuzzy logic is suggested by considering the CVT shift dynamics and on-off characteristics of the ratio control valve. It is found from experimental results that a desired speed ratio can be achieved at steady state in spite of the fluctuating primary pressure. It is expected that the low level control algorithms for the line pressure and speed ratio suggested in this study can be implemented in a prototype CVT.

Key Words : Low Level Control, Metal Belt CVT, Ratio Valve, Feedforward, Fuzzy

1. Introduction

It is well known that a continuously variable transmission (CVT) is able to achieve more efficient operating levels with respect to drive performance and fuel consumption than conventional multi-ratio gear box transmissions. However, in spite of the advantages mentioned above, earlier versions of CVTs' did not attract much attention in the market mainly due to the following two reasons. One is a simple control strategy that cannot provide various drive modes corresponding to the driver's intention and the driving environments, which is caused by the limited performance inherent to mechanical control adopted by the earlier CVTs'. The other is hydraulic system loss caused by relatively high line pressure requiring up to 50 bars that is 4 to 5 times higher than those of automatic transmissions. The above problems can be solved by

adopting electronic control. Since a fully electronically controlled CVT "Multimatic" was introduced by Honda (1996), Subaru (1996), Nissan (1997) in Japan, ZF (1996), Bosch (1996) in Germany have already presented or are preparing electronic controlled CVTs' of their own. It is expected that the future development of CVT will be forwarded to an intelligent and engine-CVT integrated control based on the electronic control strategy.

Control targets of CVT can be distinguished as speed ratio, line pressure and starting element. The speed ratio control is required to provide optimal engine operation (Song, 1997). It is an integral part which is related to the fuel economy as well as the vehicle performance. Line pressure control is a key element to hydraulic system efficiency. The line pressure is required to maintain the belt clamping force for a given speed ratio and a torque. Too much line pressure not only increases the hydraulic loss but also causes high stress in the belt. On the contrary, insufficient line pressure causes a gross slip between the belt and the pulley. So, adequate control of the speed ratio and the line pressure is essential for the development of the electronic controlled CVT.

* Corresponding Author,

E-mail : hskim@me.skku.ac.kr

TEL : +82-331-290-7438 ; FAX : +82-331-290-5849

Department of Mechanical Design Engineering, Sungkyunkwan University, 300, Chunchun-dong, Suwon, Kyonggi-do, 440-746, Korea. (Manuscript Received October 26, 1999; Revised March 9, 2000)

The control of speed ratio and the line pressure can be classified as high level and low level control. In the high level control, the optimal CVT ratio and the optimal line pressure are obtained with respect to the driver's intention and the driving environments. Outputs of the high level control are used as inputs of the low level controller. In the low level control, the target CVT ratio and the line pressure are realized through actuators by compensating error between the reference input and the feedback output. Since the low level control strategy directly depends on the control mechanism and actuator type by the CVT manufacturer, only a few studies have been reported. Hirano et. al. (1991) suggested a PI control strategy with adaptive gain using PWM high speed solenoid valve to control the speed ratio and the line pressure. Sato et. al. (1996) used a PI control for the line pressure and a PID control for the speed ratio. In their system, proportional solenoid valves are used as the actuators for both the line pressure and the speed ratio. However, the above studies have not dealt with the CVT shift dynamics. Since the line

pressure and the primary actuator pressure, which are directly related to the speed ratio, are determined by the flow balance of the hydraulic valves, the flow rate which is generated by the CVT movable flange during the transient shift should be considered together with the characteristics of the hydraulic control valves for the low level control of the CVT.

In this paper, low level control algorithms for the line pressure and the speed ratio are suggested for an electronically controlled metal belt CVT by considering ineffective duty range of the actuator, nonlinear behavior of the CVT shift dynamics, and on-off characteristics of the ratio control valve.

2. Modeling of Electronic Controlled CVT

In Fig. 1, a schematic diagram of an electronic controlled CVT used in this study is shown. The line pressure is regulated by a line regulator valve (LRV), which is operated by a variable force solenoid (VFS) type line pressure control

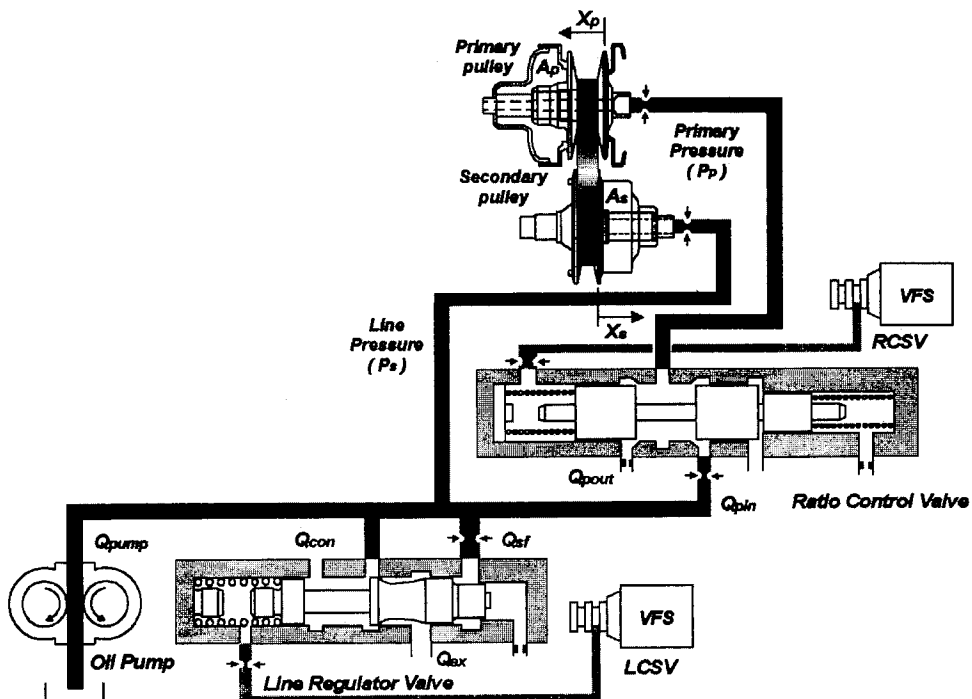

Fig. 1 Schematic diagram of an electronic controlled CVT

solenoid valve (LCSV). The LCSV generates a control pressure P_c which is applied to land #1 of the LRV spool. If the input duty decreases, P_c increases and the spool moves to the right side to close the exhaust port, which results in increased line pressure. If the input duty increases, P_c decreases and the decreased line pressure is obtained. So, the line pressure control is achieved by the LCSV duty control. The ratio control valve (RCV) is also operated by the VFS type ratio control solenoid valve (RCSV). If the input duty increases, the control pressure applied to land #2 of the RCV spool decreases, so the spool moves to the left side. This causes the exhaust port to open, thus the primary pressure decreases and the belt pitch radius decreases, which results in the downshift of the CVT ratio. The upshift can be obtained by decreasing the duty ratio of the RCSV. State equations of the secondary and the primary actuator pressure are represented as

$$\dot{P}_s = \frac{\beta}{V_s + A_s X_s} [Q_{pump} - Q_{pin} - Q_{con} - Q_{sf} - Q_{ex} - A_s \frac{dX_s}{dt}] \quad (1)$$

$$\dot{P}_p = \frac{\beta}{V_p + A_p + X_p} [Q_{pin} - Q_{pout} - A_p \frac{dX_p}{dt}] \quad (2)$$

where β is the bulk modulus, V is the initial volume of the actuator, A is the actuator area, X and dX/dt are the displacement and velocity of the CVT movable flange. Q is the flow rate. Subscript s denotes the secondary, p the primary. The last term of Eq. (1) and Eq. (2) represents the flow rate by the movement of the CVT movable flange during the ratio changing state. The velocity of the movable flange is directly related to the CVT shift dynamics as follows :

$$\frac{di}{dt} = \frac{di}{dX} \frac{dX}{dt} \quad (3)$$

where i is the CVT speed ratio, di/dX is the gradient of the speed ratio with respect to the flange displacement and depends on the CVT geometry. Figure 2 shows the relationship between the CVT ratio i and the movable flange displacement X for the primary and the second-

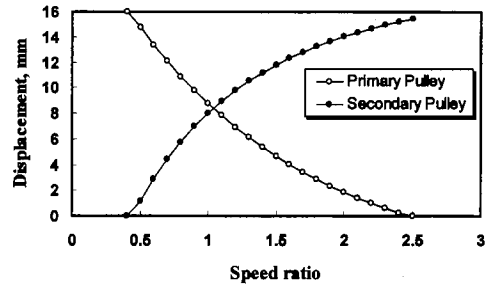

Fig. 2 Movable pulley displacement vs. speed ratio

ary pulley. The gradient di/dX can be obtained from Fig. 2. So, in order to obtain the flow rate by the CVT flange movement, the shift dynamics di/dt should be required.

3. CVT Shift Dynamics and Frequency Response

In this work, a CVT shift dynamics suggested by Ide (1995) was used based on the experiment (1998) as follows :

$$\frac{di}{dt} = \alpha(i) \omega_p (P_p - P_p^*) \quad (4)$$

where $\alpha(i)$ is the coefficient which is a function of the speed ratio, ω_p is the primary speed, P_p is a primary pressure, P_p^* is a steady state primary pressure for a given torque and a speed ratio. From the view point of ratio controller design, it is important to understand the response characteristics of the CVT of the shift dynamics. In the metal belt CVT, the ratio shift is obtained by changing the primary pressure P_p . Thus, in this study, frequency response of the CVT shift dynamics is investigated with respect to the primary pressure variation. Since P_p^* is a function of the speed ratio i and the secondary pressure P_s , the CVT dynamics Eq. (4) is basically a non-linear equation. So, in order to obtain the frequency response, a linear form of Eq. (4) is required.

A linearized form of Eq. (4) is obtained for perturbation states δ at the operating point as follows:

$$\frac{d\delta i}{dt} = \alpha_o \omega_{p_o} (\delta P_p - K_o \delta i) \quad (5)$$

where $K_o = \partial P_p^* / \partial i|_o$

In Eq. (5), since it can be assumed that the secondary pressure is maintained at a constant during the ratio shift, the perturbation of P_p^* can be expressed only as a function of i . Additionally, the constant α_o can be assumed as constant at the operating point. The Laplace transformation of Eq. (5) is represented as

$$\frac{\delta i(s)}{\delta P_p(s)} = \frac{1/K_o}{\tau s + 1} \tag{6}$$

where $\tau = 1/\alpha_o \omega_p K_o$.

The frequency response of Eq. (6) is plotted in Fig. 3. In order to investigate the effects of the speed ratio, the frequency response is obtained for the two operating points, (1) underdrive $i=2.5$ and (2) overdrive $i=0.45$. For these operating points, the same primary speed and the line pressure are used as $\omega_p=1000$ rpm and $P_s=10$ bar. It is seen from Fig. 3 that the magnitude and phase for the underdrive shows different characteristics from those for the overdrive, which demonstrates nonlinear characteristics of the CVT shift dynamics. In other words, a different shift magnitude and speed are expected depending on the speed ratio range for the same primary pressure change. This implies that a nonlinear control

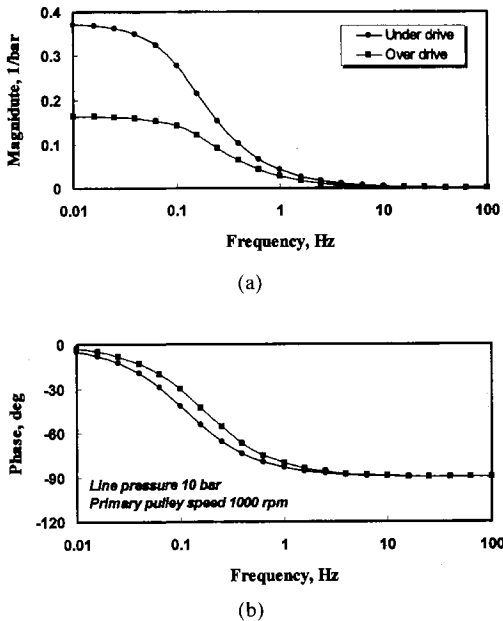

Fig. 3 Frequency response

algorithm is required for the CVT ratio control. Additionally, it is found that the magnitude of the CVT ratio change approaches zero for the primary pressure variation with high frequency. This means that a constant CVT ratio can be achieved for the high frequency pressure variation.

4. Steady State Characteristics of LRV and RCV

In Fig. 4, the line pressure characteristics of the LRV with respect to the LCSV duty at steady state are plotted for various pump speeds and compared with experimental results. As shown in Fig. 4, the effective duty range where the line pressure can be controlled depends on the pump speed. It is seen that as the pump speed decreases, the effective duty range decreases since the efficiency of the pump decreases with the decreased speed. The simulation results are in good accordance with the experiments. In Fig. 5, performance characteristics of the RCV from the simulation are compared with those of the experiment. From Fig. 5, the effective duty range where the primary pressure can be controlled is observed as 37~45 % in the simulation and 37~44 % in the experiment. It is considered that the effective duty range is so narrow that the RCV seems to operate like an on-off valve, which may cause a pressure fluctuation in the primary actuator. As shown in

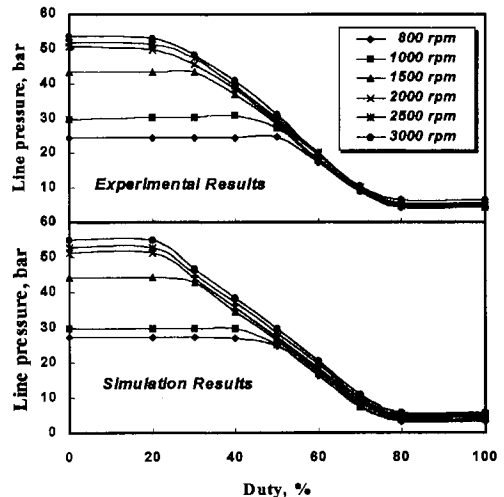

Fig. 4 Line pressure characteristics

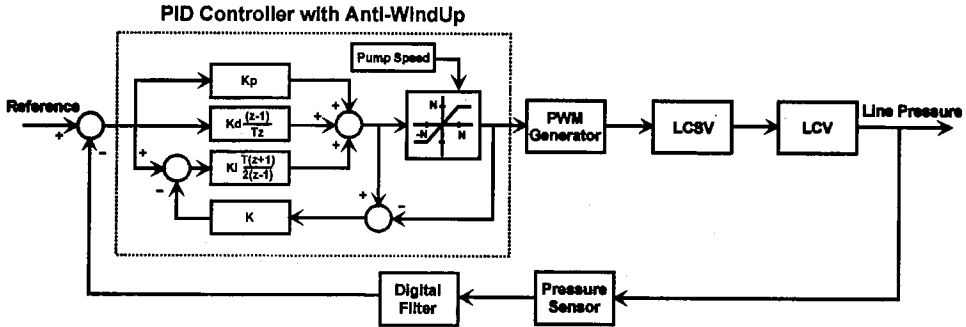

Fig. 6 Block diagram of low level control for line pressure

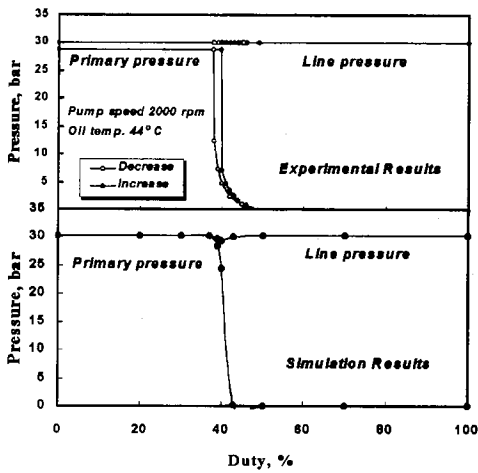

Fig. 5 RCV characteristics

Fig. 5, the simulation results agree well with the experiment.

5. Low Level Control of Line Pressure

Before carrying out the ratio control system design, line pressure control should be performed for the following reasons: (1) to prevent the belt slip, (2) to improve the hydraulic system efficiency, and (3) to minimize the effect of the line pressure variation on the ratio control. Figure 6 shows a block diagram of the low level control for the line pressure. Considering the characteristics of the effective duty range of the LRV, an anti-windup PID controller is suggested with changing anti-windup range with respect to the pump speed. Control gains $K_p=0.15$, $K_i=11.0$ and $K_d=0.01$ were obtained by experiments after selecting the approximate gains based on Ziegler

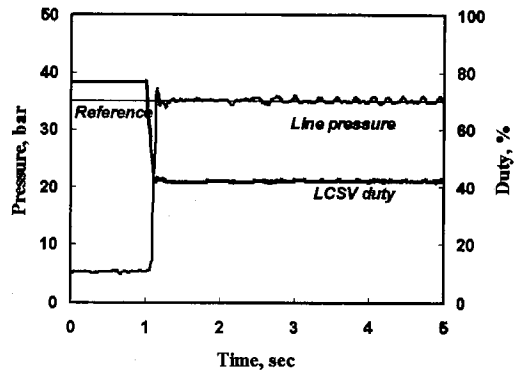

Fig. 7 Line pressure response of LRV

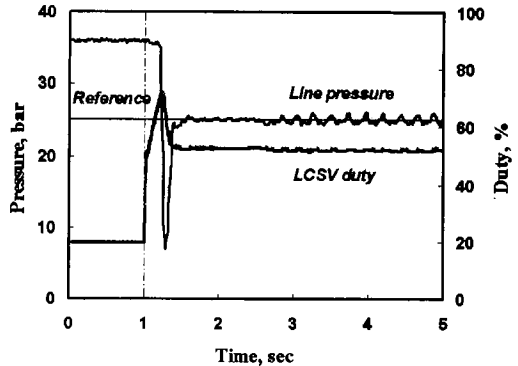

Fig. 8 Line pressure response for ineffective duty range

-Nichols tuning. In Fig. 7, the line pressure response of the LRV is plotted for the stepwise input of the LCSV duty ratio. It is seen from Fig. 6 that the LRV using the anti-windup PID control algorithm shows fast response for the stepwise increase of the line pressure. The peak time is observed as less than 0.1 sec. When the engine torque increases suddenly such as in a kickdown

maneuver, the response time of the line pressure should be faster than the torque response time in order to prevent the belt slip. The peak time shown in Fig. 7 is considered to be fast enough considering the engine dynamics. In this study, the target peak time is selected as $t_p=0.2$ sec. In Fig. 8, the line pressure response is shown for the stepwise decreasing input when the initial duty starts from the ineffective range. From Fig. 8, the response delay of 0.25 sec. is observed in addition to the large undershoot. The response delay is due to the response lag of the LRV when the duty

signal moves from the ineffective region to the effective region. Additionally, in the response delay period, the error between the reference input and the line pressure is accumulated and this error is amplified by the integral action of the PID control, which results in the large undershoot. In Fig. 9, test results of the robustness of the line pressure control system with anti-windup PID control is plotted. As a disturbance, the speed ratio is varied from the lowest gear ratio $i=2.45$ to the highest ratio $i=0.46$ (Fig. 9(b)), while the target line pressure is maintained at 25 bars. When the upshift begins from the lowest gear ratio, the line pressure decreases (Fig. 9(a) A) since part of the oil supply from the pump is used to fill up the actuator volume which is empty in the initial state. The line pressure increases by the flow rate from the secondary actuator and the feedback action of the LRV and shows a large oscillation (Fig. 9(a) B). This pressure oscillation is caused by the integral action of the PID controller which tries to compensate for the accumulated error. The large undershoot in the line pressure shown in Fig. 8 and Fig. 9 may cause slip between the belt and the pulley resulting in a failure in the power transmission. So this large undershoot should be reduced.

In order to reduce the large undershoot in the line pressure, a feed forward control is added to the anti-windup PID controller (Fig. 10). The feed forward gain K_f is selected to generate a line pressure higher than the reference based on a steady state relationship between the input duty and the line pressure to reduce the large under-

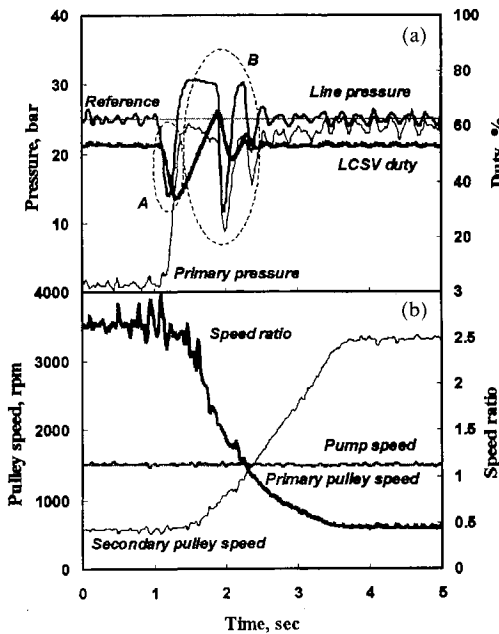

Fig. 9 Test results of robustness for line pressure control system

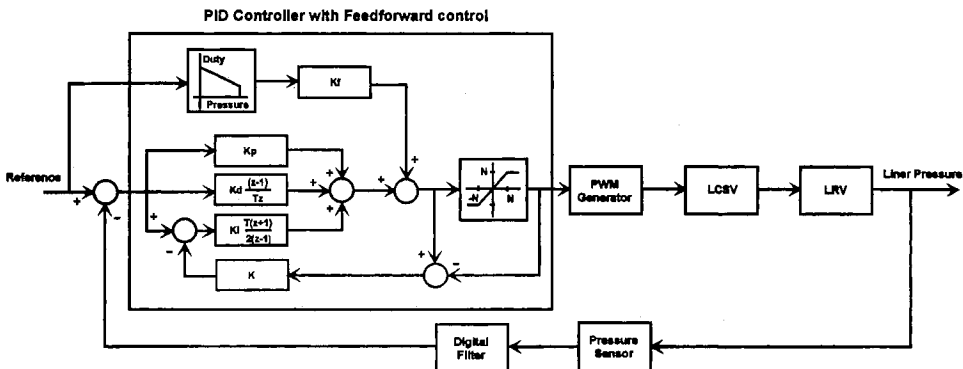

Fig. 10 Block diagram of feedforward control for line pressure

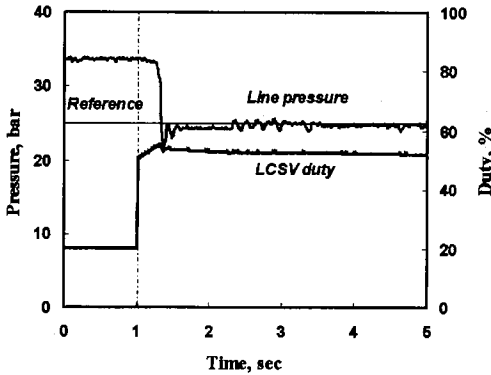

Fig. 11 Line pressure response for feedforward controller

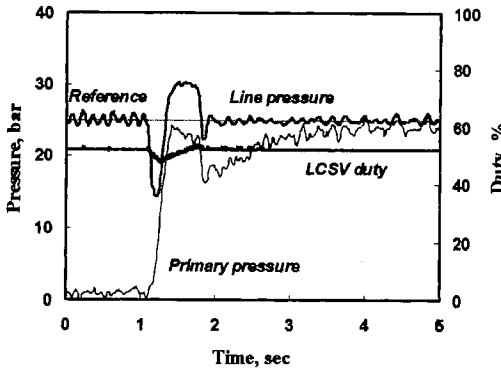

Fig. 12 Line pressure response at upshift with feed-forward controller

shoot. In Fig. 11, line pressure response of the LRV using the feed forward anti-windup PID control is plotted. It is seen from Fig. 11 that the line pressure undershoot is almost eliminated by the feed forward action even if the response delay time increases a little compared with the response by the PID control (Fig. 7). In Fig. 12, robustness test results of the feed forward PID controller are shown when the speed ratio changes as shown in Fig. 9(b). It is observed that the pressure oscillation (Fig. 9(b) B) is reduced by a great amount. From Fig. 7, Fig. 11 and Fig. 12, it is found that the line pressure by the feed forward anti-windup PID control shows a fast response which guarantees no belt slip in the case of fast engine torque rise and shows a reduced undershoot, which prevents the belt from slip.

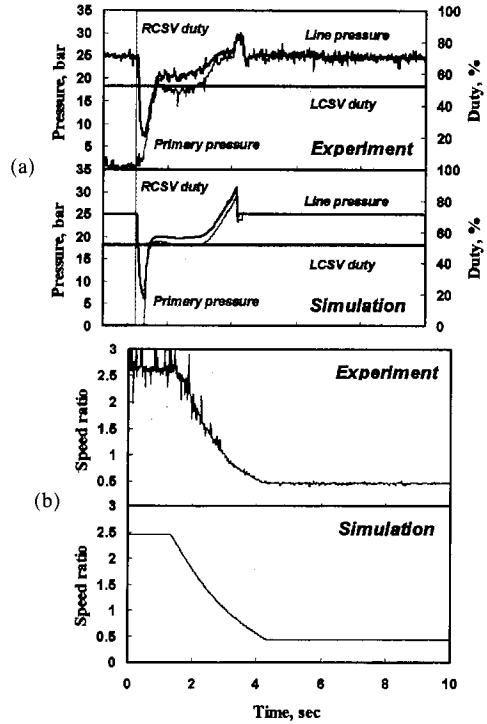

Fig. 13 Dynamic characteristics of CVT system

6. Low Level Control of Speed Ratio

The design of the CVT ratio low level controller was carried out based on the dynamic models of the CVT system obtained. At first, in order to use the dynamic models in control system design, the validity of the dynamic models should be investigated at the transient state.

In Fig. 13, dynamic characteristics of the CVT system by simulation are compared with the experimental results. In the simulation, dynamic models of the LRV and the RCV were used including the CVT shift dynamics, Eq. (4). Simulations were performed for the stepwise input of the RCSV duty from 100 % to 0 % at oil pump speed $\omega_p=1000$ rpm while the line pressure is controlled to maintain 25 bars. As shown in Fig. 13(a), the line pressure decreases rapidly as soon as the RCSV input duty is applied. This results from the insufficient oil flow rate since the oil flow from the pump is used to fill up the empty volume in the primary actuator when the shift begins from the lowest gear ratio. The line pres-

sure increases sharply as the primary pressure builds up. Then the line pressure increases slowly by the feedback action of the LRV and by the increased oil flow due to the secondary flange movement as the shift goes on. The primary pressure builds up with some time delay and follows the line pressure. The CVT ratio changes from the lowest gear ratio, $i=2.45$ to the highest, $i=0.46$. As shown in Fig. 13, the simulation results of the line pressure, primary pressure and the CVT ratio are in good accordance with the experimental results, showing that the dynamic models of the CVT system derived are valid.

A fuzzy logic based ratio controller was designed using the dynamic models of the CVT system. Fuzzy control logic was adopted considering nonlinear characteristics of the CVT shift dynamics and the on-off characteristics of the RCV as described in the previous sections. The fuzzy rule base suggested in this study is shown in Fig. 14. As shown in the fuzzy rule base in Fig. 14, medium (M) or very big (VB) variables are used near zero (ZE) rather than small variables in order to respond to the on-off characteristics of the RCV. Since the RCV has a characteristic of a flow control valve and the CVT has a response

lag in the ratio change, it is required to use large variables such as M or VB near zero values of the error and changes in the error. The fuzzy control gains were obtained based on simulations, and the final control gains were determined through experiments. For the fuzzy logic control, considering the RCV characteristics, it is designed such that the computation time which calculates the error of the ratio and the rate of the error can be changed depending on the velocity of the rate of the CVT ratio. In Fig. 15, a block diagram of the fuzzy control is shown. Figure 16 shows the response of the ratio control by fuzzy logic for the stepwise input of the CVT ratio from $i=2.45$ to i

	NVB	NVB	NVB	NVB	NVB	NB	NM	NS	ZE
	NVB	NVB	NVB	NVB	NB	NM	NS	ZE	PM
	NVB	NVB	NVB	NVB	NM	NS	ZE	PM	PB
	NVB	NVB	NVB	NB	NS	ZE	PM	PB	PVB
	NVB	NVB	NB	NM	ZE	PM	PB	PVB	PVB
	NB	NM	NM	ZE	PS	PB	PVB	PVB	PVB
	NB	NM	ZE	PS	PM	PVB	PVB	PVB	PVB
	NM	ZE	PS	PM	PB	PVB	PVB	PVB	PVB
	ZE	PS	PM	PB	PVB	PVB	PVB	PVB	PVB

Fig. 14 Fuzzy rule base

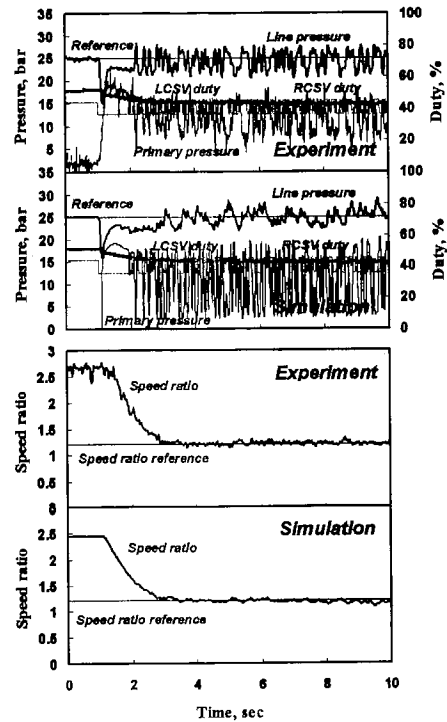

Fig. 16 Speed ratio response for fuzzy control

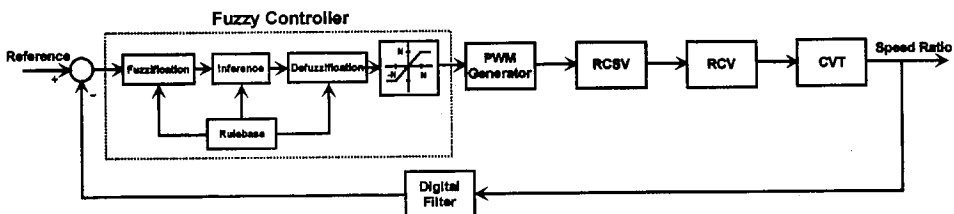

Fig. 15 Block diagram of fuzzy control for CVT speed ratio

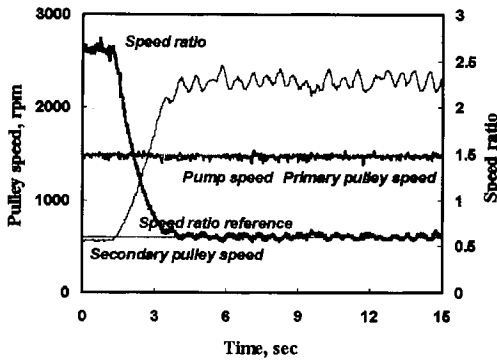

Fig. 17 Speed ratio response for fuzzy control

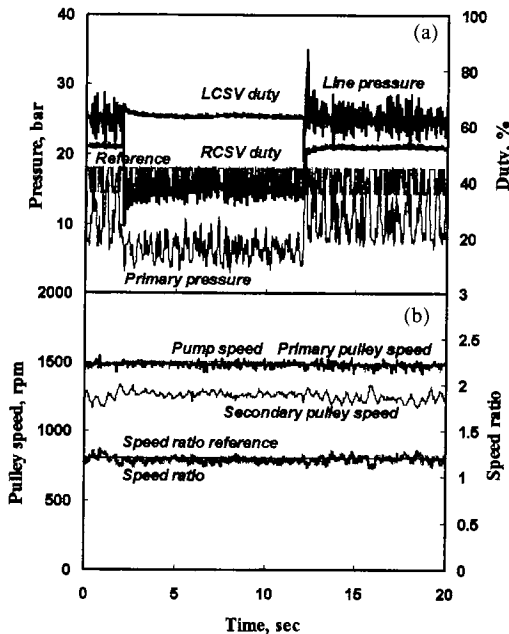

Fig. 18 Response for line pressure disturbance with fuzzy control

= 1.2 while the line pressure is kept at 25 bars. It is seen from Fig. 16 that the RCSV input duty shows high frequency oscillation and correspondingly the primary pressure oscillates. This high frequency oscillation is due to the RCV characteristics. As shown in Fig. 5, the effective duty range is so narrow that the primary pressure changes greatly even for a small change of the input duty. So, when the duty signal changes to obtain the desired speed ratio by the fuzzy algorithm, the primary pressure fluctuates in accordance with the duty signal. However, in spite of the primary

pressure fluctuation, the CVT ratio follows the reference input and maintains the desired ratio at steady state since the average value of the fluctuating pressure works to generate the desired speed ratio by the fuzzy logic suggested in this study. In Fig. 16, experimental results of the CVT ratio using the fuzzy logic control are plotted for the stepwise input of the speed ratio from $i=2.45$ to $i=0.6$. It is seen from Fig. 17 that the desired speed ratio is obtained at a steady state. In Fig. 18, test results of the robustness are shown. As a disturbance, the line pressure is changed in a stepwise manner from 25 bars to 15 bars and vice versa while the reference speed ratio is maintained at $i=1.2$. As shown in Fig. 18, the target speed ratio is maintained by the fuzzy logic control in spite of the line pressure disturbance.

From the experimental results in Fig. 16~Fig. 18, it is found that the fuzzy logic based ratio control shows good tracking performance and robustness in spite of the nonlinear CVT shift dynamics and the on-off characteristics of the RCV.

7. Conclusion

Low level control algorithms of a metal belt CVT are suggested for the line pressure and the speed ratio. The following conclusions are obtained:

(1) Dynamic models of the CVT system including the line regulator valve, the ratio control valve and the CVT shift dynamics are obtained. From experiments and simulation results, it is found that the ratio control valve has a narrow operating duty range and may behave like a on-off valve. Additionally, it is seen from the frequency response analysis that the CVT shift dynamics show nonlinear behavior, which requires a corresponding control logic to manage these characteristics.

(2) A feedforward anti-windup PID control algorithm is suggested for the line pressure control by considering the ineffective duty range of the solenoid valve. Experimental results show that the line pressure control algorithm guarantees fast response while reducing the pressure undershoot

which may result in belt slip.

(3) Based on dynamic models of the CVT system, a fuzzy logic ratio control algorithm is suggested considering the on-off characteristics of the ratio control valve and the nonlinear behavior of the CVT shift dynamics. In the fuzzy logic control, variable computation time for the error of the ratio and the rate of the error is used depending on the velocity of the rate of the CVT ratio. Experimental results of the CVT ratio by fuzzy control shows that good tracking performance and robustness can be obtained. It is expected that the low level control algorithm for the line pressure and the speed ratio suggested in this study can be implemented in a prototype CVT.

References

- Boos, M., Mozer, H., 1996, "CVT at ZF", *Proc. Int. Conf. on Continuously Variable Transmission*, pp. 37~42.
- Engelsdorf, K., Senger, K. H., Bolz, M. P., 1996, "Electronic CVT Control for Power Train Optimization," *Proc. Int. Conf. on Continuously Variable Transmission*, pp. 71~76.
- Funatsu, K., Koyama, H., Aok, T., 1996, "Electronic Control System of Honda for CVT," *Proc. Int. Conf. on Continuously Variable Transmission*, pp. 43~52.
- Hirano, S., Miller, A. L., Schneider, K. F., 1991, "SCVT-A State of the Art Electronically Controlled CVT," *SAE Paper 910410*, pp. 33~48.
- Ide, T., Uchiyama, H., Kataoka, R., 1996, "Experimental Investigation on Shift Speed Characteristics of a Metal V-Belt CVT," *Proc. Int. Conf. on Continuously Variable Transmission*, pp. 59~64.
- Ide, T., Udagawa, A., Kataoka, R., 1995, "Simulation Approach to the Effect of the Ratio Changing Speed of a Metal V-Belt CVT on the Vehicle Response," *Vehicle System Dynamics*, Vol. 24, pp. 377~388.
- Kim, T. C., Jeon, J. W., Kim, H. S., 1998, "Performance of Fuzzy Logic Based Engine-CVT Consolidated Control," *Proc. Global Powertrain Congress*, Vol. 3, pp. 1~9.
- Kurosawa, M., Fujikawa, T., Yoshida, K., Kobayashi, M., 1997, "Development of High Torque Belt CVT with Torque Converter," *Japan Automotive Technology*, Vol. 51, No. 9.
- Sato, T., Sakakiyama, R., Nakamura, H., 1996, "Development of Electronically Controlled CVT System Equipped with CVTip," *Proc. Int. Conf. on Continuously Variable Transmission*, pp. 53~58.
- Song, H. L., Kim, J. J., Kim, H. S., 1997, "Shifting Characteristics of PWM Electro-Hydraulic Controlled CVT and Engine Optimal Operation," *Trans. of KSME*, Vol. 21, No. 4, pp. 646~654.