

Neural Network Tuning of the 2-DOF PID Controller With a Combined 2-DOF Parameter For a Gas Turbine Generating Plant

Dong-Hwa Kim

Dept. of I&C, Taejon National University of Technology, 16-1 San
Duckmyong-Dong Yusong Gu Taejon City Seoul, Korea, 305-320.

Abstract

The purpose of introducing a combined cycle with gas turbine in power plants is to reduce losses of energy, by effectively using exhaust gases from the gas turbine to produce additional electricity or process. The efficiency of a combined power plant with the gas turbine increases, exceeding 50%, while the efficiency of traditional steam turbine plants is approximately 35% to 40%. Up to the present time, the PID controller has been used to operate this system. However, it is very difficult to achieve an optimal PID gain without any experience, since the gain of the PID controller has to be manually tuned by trial and error procedures. This paper focuses on the neural network tuning of the 2-DOF PID controller with a combined 2-DOF parameter (NN-Tuning 2-DOF PID controller), for optimal control of the Gun-san gas turbine generating plant in Seoul, Korea. In order to attain optimal control, transfer function and operating data from start-up, running, and stop procedures of the Gun-san gas turbine have been acquired and a designed controller has been applied to this system. The results of the NN-Tuning 2-DOF PID are compared with the PID controller and the conventional 2-DOF PID controller tuned by the Ziegler-Nichols method through experimentation. The experimental results of the NN-Tuning 2-DOF PID controller represent a more satisfactory response than those of the previously-mentioned two controllers.

Key Words : Neural Network, 2-DOF PID controller, Gas turbine, 2-DOF parameter

1. Introduction

The role of combined power generation plants has become more important over recent years, due to technological advances and the changing needs of the energy market.

Therefore, studies on the control of gas turbines have been the subject of interest, since gas turbine engines have been widely adopted as peak load candidates for electrical power generation [1]. The fully automatic start-up function and the fast running-up characteristics of gas turbine systems have made them particularly suitable for peak-load lopping and stand-by power supply purposes.

The start-up procedure for a gas turbine consists of several stages: warming up of the main steam pipeline, warming up of turbine parts, turbine run-up, synchronization, and loading. So, the various studies about control at each step, from start-up to loading, are required for stability and safety [3]. Start-up and shutdown procedures are the most challenging problems to consider when developing new control algorithms for a gas turbine.

In order to successfully develop new algorithms for the controller, the performance of the controller must be proven through a sequence of operating stages. At the

same time, it must have a function which can monitor many kinds of variables, to ensure safe operation [3], [4].

Moreover, minimum time and energy losses during the start-up or running-up procedures would be desirable.

Additional problems are involved with start-up or shut down of certain components within a larger power station. This is especially difficult in combined cycle gas turbines, because interconnections between components occur not only through the electric network but also on the heat exchange side, i.e. the flows of gas and steam.

Hence, failure to operate will cause an inevitable plant shutdown, from which production loss and considerable damage to the plant may result. Therefore, a more accurate gas turbine control technology than those previously studied is required to maintain system stability following a disturbance [2], [4].

This paper focused on the neural network tuning of a 2-DOF PID controller with a combined 2-DOF parameter (NN-Tuning 2-DOF PID controller). This controller was designed and tested after acquiring transfer function and operating data from start-up, running, and stop procedures of the Gun-san gas turbine generation plant in Korea. For optimal tuning of a designed NN-Tuning 2-DOF PID controller, a neural network is used.

II. Gun-san Gas Turbine Generating Plant

2.1 The model of the Gun-san Gas Turbine System

The model of the gas turbine is composed of compressor, combustor, turbine, and fuel system as in the

arrangement shown in Fig. 1 [4].

In Fig. 2,

- W_{air} =Air flow to the turbine
- W_{fuel} =Fuel flow to the turbine
- W_{inj} = Steam (water) injection flow
- P_{ar} =Enthalpy, density, pressure and temperature of inlet air, and temperature of injection liquid
- P =Mechanical power
- ω =Rotational speed
- g_{no} = N_{∞} content in exhaust gas
- T_o =Exhaust gas temperature
- W_o =Exhaust gas flow
- h_o =Exhaust gas enthalpy

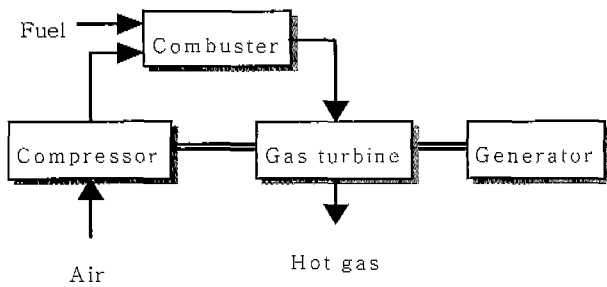

Fig. 1 (a). Gas turbine system.

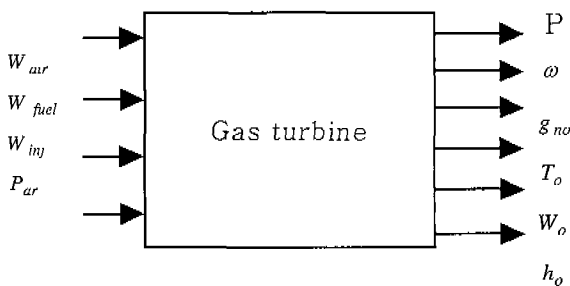

Fig. 1 (b). The control variables of the gas turbine system.

The fuel system in the gas turbine consists of the fuel valve and the actuator, and these devices regulate the fuel flow to the gas turbine.

On the other hand, if air at atmospheric pressure enters the compressor, this air is compressed to achieve the most favorable conditions for combustion. The compressed air is mixed with the fuel offered from the fuel system within the combustion chamber, and combustion takes place. The hot exhaust gas from the combustion chamber produces a mechanical power by means of expanding through the turbine. That is, as the gas generating power system is a single-shaft engine, power by the expanding exhaust gas from the combustion chamber drives the compressor and high-pressure turbine, and the combined power of these components rotates a generator through a gearbox. A detailed model is given

in reference [2], [3].

In order to design the proper controller for a gas turbine generating plant, all components of the generating plant should be represented by a linear model, which is devised assuming that the components, including a gas turbine engine, can be represented as a collection of multivariable functions. This method has been extensively used in gas turbine control studies up to now [2], [3].

However, it is very difficult to design a controller using the modeling procedure of a gas turbine with the nonlinear characteristics.

As described above, in a gas-turbine engine, the fuel flow, gas temperature, and inlet guide vane opening are very important factors for the efficiency of the gas turbine. So, the dependent variables chosen for modeling are the fuel system, the compressor discharge pressure, the exhaust gas pressure, the exhaust gas temperature, and the exhaust gas power.

2.2. Control system Characteristics of the Gun-san Gas Turbine Plant

Fig. 2. represents a simplified block diagram for a single-shaft Gun-san gas turbine generating plant. The control system includes speed control, temperature control, acceleration control, and upper fuel and lower fuel limits [4].

The speed controller operates on the speed error formed between the reference speed and the rotor speed. A droop

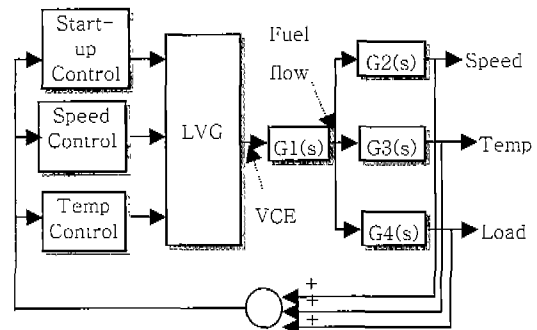

Fig. 2. Control system of the Gun-san gas turbine generating plant: VCE=fuel flow signal, G1(s)= transfer function of fuel system, G2(s)=transfer function of between fuel flow and turbine speed, G3(s)=transfer function of between fuel flow and turbine exhaust gas temperature, G4(s)=transfer function of between fuel flow and generator output.

governor is a straight proportional speed controller in which the output is proportional to the speed error.

Temperature control is the normal means of limiting gas turbine output at a predetermined firing temperature, independent of variation in ambient temperature or fuel characteristics. Acceleration and deceleration fuel schedules are basic control requirements for maintaining the gas turbine engine to operate within its safe margin, during steady state or transient conditions.

Acceleration control is used primarily during gas turbine start-up to limit the rate of rotor acceleration prior to reaching governor speed, thus ameliorating the thermal stresses encountered during start-up. This control serves a secondary function during normal operation, in that it acts to reduce fuel flow and limit the tendency to over-speed, in the event that the turbine generator separates from the system.

These three control functions (speed governing under part load conditions, temperature control acting as an upper limit, and acceleration control to prevent over-speeding) are all inputs to a low value selector. The output of the low value selector, which is called VCE, is the lowest of the three inputs, i.e., whichever requires the least fuel. Transfer from one control to another is bumpless and without any time lags. The output of the low value selector is compared with maximum and minimum limits. The minimum limit is more important. This is because the minimum limit is chosen to maintain adequate fuel flow and to insure that a flame is maintained with the gas turbine combustion system.

Gas turbine fuel systems are designed to provide energy input to the gas turbine, proportional to the product of the command signal (VCE) times the unit speed. This is analogous to the actual mode of operation of the fuel system, since liquid fuel pumps are driven at a speed proportional to turbine rotor speed, and gas fuel control is accomplished in two stages, with the output pressure of the first stage being proportional to rotor speed.

The fuel gas control system consists of two valves in series, the first of which controls the pressure between the two valves as a function of speed. The second valve has a linear characteristic versus lift range, and is aerodynamically designed so that sonic velocities are attained at the controlling area with flange-to-flange valve pressure ratios as low as 1.25. If valve position is maintained proportional to the VCE signal, the actual result is a flow rate of fuel gas, which is proportional to the gas turbine speed [4].

Both the torque and exhaust temperature characteristics of the single-shaft gas turbine are essentially linear with respect to fuel flow and turbine speed over the 95 to 107% design rating. The exhaust temperature equations are somewhat less accurate at part load; however, since temperature control is only active at the design point, the impact of the part load inaccuracy is negligible to the overall simulation [3].

An ideal acceleration control allows the engine to accelerate at a reasonably fast rate without the engine being driven into the surge region or the engine components overheating. Following load rejection, a rapid reduction of fuel flow is required to limit the maximum speed rise.

There is a minimum level to which the fuel flow can

be reduced without causing a flameout problem. A deceleration fuel schedule is required to minimize the turbine speed rise on load rejection, but it is not the flaming-out of the engine.

2.3. PID Controller in Gun-san a Gas Turbine Generating Plant

The Proportional-Integral-Derivative (PID) controller has been widely used owing to its simplicity and robustness in chemical process, power plant, and electrical systems. Its popularity is also due to easy implementation in hardware and software. However, with the only P, I, D parameters, it is very difficult to control a plant with complex dynamics, such as large dead time, inverse response, and highly nonlinear characteristics. That is, since the PID controller is usually poorly tuned, a higher of degree of experience and technology is required for the tuning in the actual plant [5].

There are many well known PI and PID tuning formulas for stable processes. However, PID tuning formulas for unstable processes or complex plants are less common.

Up to this time, many sophisticated tuning algorithms have been tried to improve the PID controller performance under such difficult conditions, since the control performance of the system depends on the P, I, D parameter gains. In many cases, especially in the actual plant, they are manually tuned through a trial and error procedure, and the derivative action is switched off, since it is difficult to tune.

Table 1. Gun-san gas turbine operating condition [4]

NO.	Name in system	Signal range	Physical standard
1	Set point	-2.5~+3.5	95~102%
2	Exhaust temp	0~6v	111~538°C
3	TBN speed	0~25v	0~3600rpm
4	VCE	0~20v	0~3600rpm
5	Fuel flow	-8~0v	0~120gpm
6	Control position	-8~+8v	0~120gpm

The Gun-san gas turbine was constructed about 30 years ago, and its PID controller tuning must be manually performed by trial and error procedures as in old plants.

So, it is very difficult to obtain the optimal PID gain without any operational experience. Table 1 represents the operating condition at each input port and out port of the Gun-san gas turbine component.

III. 2-DOF PID Controller for the Gun-san Gas Turbine Generating Plant

3.1. 2-DOF PID Controller with a Combined 2-DOF Parameter

A 2-DOF PID controller with a combined 2-DOF parameter for the Gun-san gas turbine generating plant is composed as in Fig. 3. The transfer function between the process value $PV(s)$ and the settling value $SV(s)$, and between the process value $PV(s)$ and the manipulated value, $MV(s)$ are given as the following equations, respectively:

$$G_{PVMV}(s) = -\frac{PV(s)}{MV(s)} = K_p \left(1 + \frac{1}{T_i s}\right) + \frac{K_p T_d s}{1 + \eta T_d s} \quad (1)$$

$$G_{PVMV}(s) = \frac{PV(s)}{MV(s)} \cong \frac{1 + T_d s + T_d s}{T_i s [1 + T_i s (1 + \alpha \beta) + T_d s (\eta + \alpha \gamma)]} \quad (2)$$

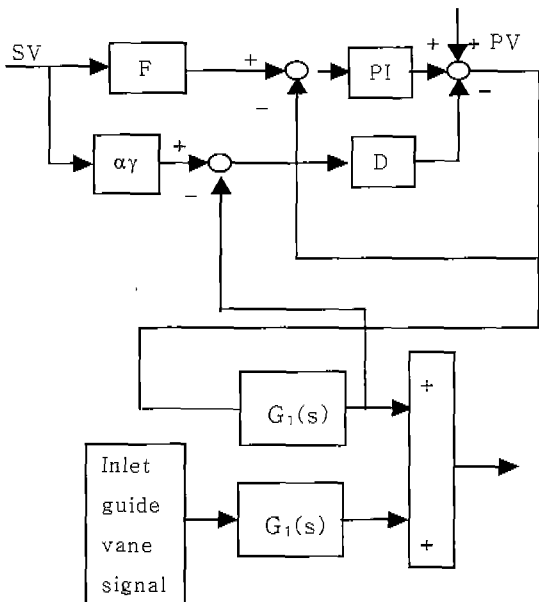

Fig. 3. The structure of the 2-DOF PID controller with a combined 2-DOF parameter for the Gun-san gas turbine

where, $F(s) = \frac{1 + \alpha \beta T_i s}{1 + \beta T_i s}$: filter transfer function,

$PI(s) = K_p \left(1 + \frac{1}{T_i s}\right)$: PI controller transfer function,

$D(s) = \frac{K_p T_d s}{1 + \eta T_d s}$: D controller transfer function,

$$G_1(z) = \frac{-0.083z + 0.0665}{z^2 - 0.441z - 0.453}$$

$G_1(s) = \frac{0.057z + 0.0167}{z^2 - 0.441z - 0.453}$: plant transfer function,

respectively. In equation (1), the gain, K_p, T_i, T_d of the controller has a similar function as that of the conventional PID controller. That is, the gain K_p, T_i, T_d is tuned to the change of the process value $PV(s)$.

However, in equation (2), in response to the change of the settling value $SV(s)$, the integral effect is $(1 + \alpha \beta)$ times the integral gain T_i , and the derivative term

results in $(\eta + \alpha \gamma)$ times the derivative gain T_d . That is, the settling value $SV(s)$ depends on the two degrees parameter α, β, γ .

In the long run, since the process value can be controlled by gains K_p, T_i, T_d , and the settling value is affected by the two degrees parameter α, β, γ , the 2-DOF PID parameter can have two degrees of function completely.

3.2. Tuning of 2-DOF PID Controller by Neural Network

The ultimate method, the Z&N method, has been implemented for the tuning of the 2-DOF PID controller.

This paper used the back propagation of the neural network for the tuning of the 2-DOF PID controller and endeavored to avoid the adoption of a neural network with a complicated structure, if possible, because this controller

should actually be applied in a Gun-san turbine generating plant.

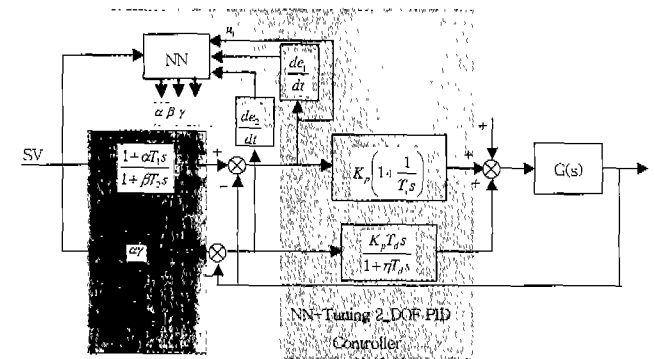

Fig. 4 (a). Neural network of the 2-DOF PID controller with a combined 2-DOF parameter for the Gun san gas turbine

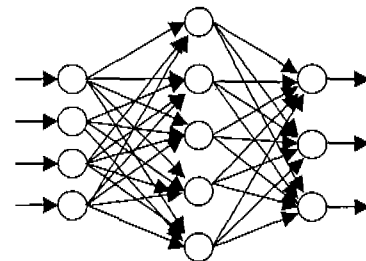

Fig. 4 (b). The structure of the neural network.

Fig. 4(a) illustrates the architecture of the 2-DOF PID controller with the neural network for the Gun-san gas turbine, and Fig. 4(b) represents the structure of the applied neural network. The neural network has reference signal (SV) , $u_1, \frac{de_1}{dt}$, and $\frac{de_2}{dt}$ as inputs and the parameter α, β, γ for two degrees of function of the 2-DOF PID controller as the tuning output.

The number of hidden layers can be adjusted in the

learning procedure by the user. The neuron equation is given by equation (4), and the sigmoid function is defined as a logistic function of equation (5), respectively.

$$y_i(t) = f\left(\sum_{j=1}^m w_j x_j(t) + b\right), \quad (3)$$

$$f(x) = \frac{1}{1 + e^{-\lambda x}} \quad \frac{dx}{dt} = \lambda f(x)(1 - f(x)). \quad (4)$$

The network weights are minimized by the following performance index:

$$P(w) = \frac{1}{2} \left(\sum_{j=1}^n (d_i - y_i)^2 \right) = \frac{1}{2} \left(\sum_{j=1}^n (d_i - w^T x_i)^2 \right) \quad (5)$$

IV. Experiments and Discussion

4.1. Transfer Function and Operating Data of the Gun-san Gas Turbine by the Data Acquisition System

First of all, this paper acquired the transfer function and the operating data during the operating procedure (start-up, running, and stop) of the Gun-san gas turbine generating plant to compare characteristics between the conventional PID or the 2-DOF PID controller and the NN based 2-DOF PID controller with a combined 2-DOF parameter, which is tuned by a neural network.

Fig. 5 shows the block diagram of the data acquisition system, to acquire the operating data for running. Fig. 5 indicates that the main transfer function of the Gun-san gas turbine is composed of two parts: start-up control and temperature control. Fig. 6 represents the curve of the operating data and transfer function for start-up and running. These results reveal that both curves are coinciding.

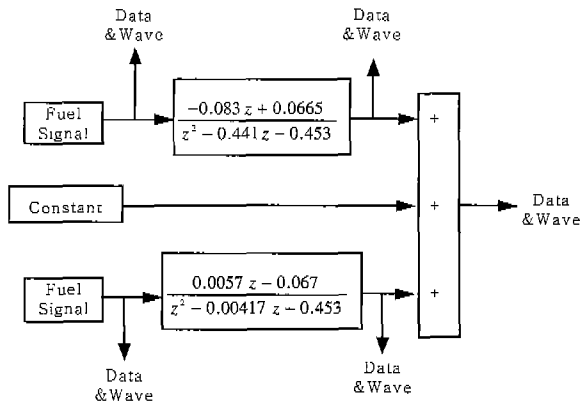

Fig. 5. The structure of transfer function in the Gun-san gas turbine.

Fig. 7 illustrates the response of each parameter to operating data during start-up, running, and stop procedures, without any control functions. Where Flow Signal (FS) is the fuel signal provided by a controller,

Fuel Flow (FF) is the actual fuel flow signal, Gas Temperature (GT) is the gas temperature signal, Flow Gas Temperature (FGT) is the signal of gas temperature when gas is flowing, and Inlet Guide Vane Opening (IGVO) is the inlet guide vane opening signal.

Fig. 8 represents the response of each parameter for only the start-up procedure. Its result shows that the FF does not follow the FS well, because there is no controller, and since the IGTO is more open, the gas temperature (GT) is lower.

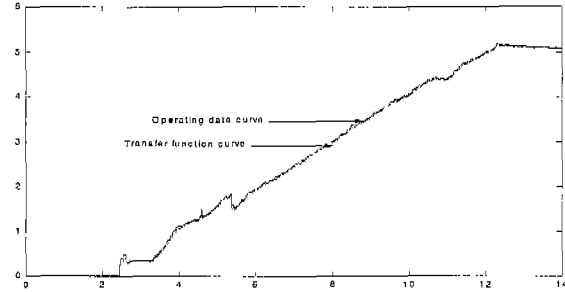

Fig. 6. Operating data curve and transfer function curve.

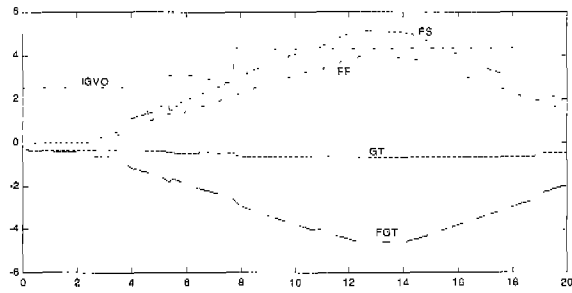

Fig. 7. Characteristics of each parameter during the start-up, running, and stop procedure of the Gun-san gas turbine.

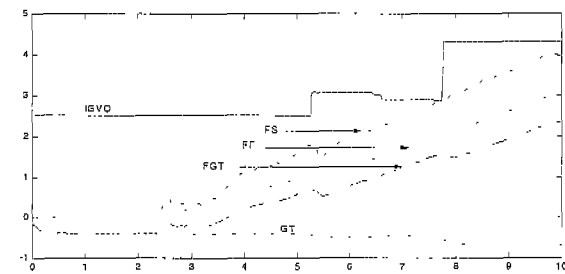

Fig. 8. The characteristic of each parameter in the start-up procedure of the Gun-san gas turbine.

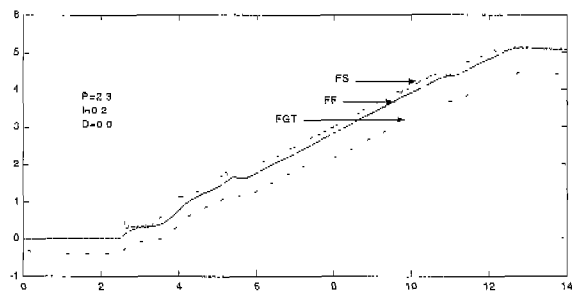

Fig. 9. Fuel loop feedback control by the PID controller ($P=2.3$, $I=0.2$, $D=0$).

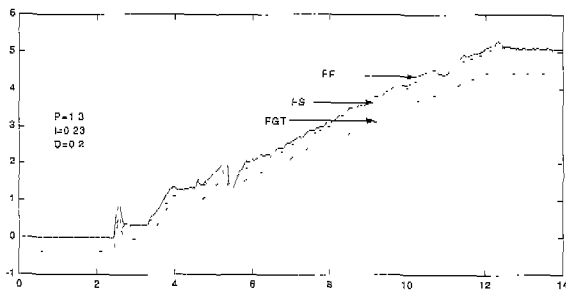

Fig. 10. Fuel loop feedback control by the PID controller (P=1.3, I=0.23, D=0.2).

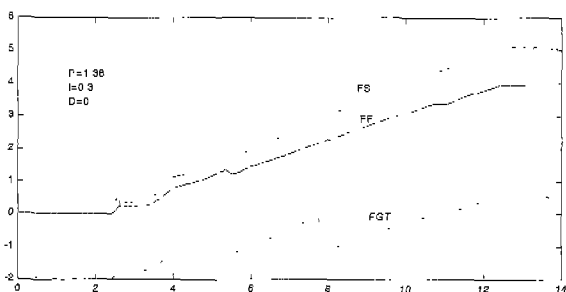

Fig. 11. Fuel loop feedback control by the PID controller in gas temperature disturbance (P=1.38, I=0.3, D=0).

4.2. The Characteristics of PID Controller

In order to compare the characteristics of the PID controller and the conventional 2-DOF PID tuned by the Ziegler-Nichols method, we experimented with these controllers on the transfer function and data obtained from the operating procedure of the Gun-san turbine. Figs. 9-12 represent the responses of the PID controller. The results of fuel loop feedback control of Fig. 9 and Fig. 10 show that the fuel flow (FF) follows the flow signal, but the results of Fig. 11 and Fig. 12 during a gas temperature disturbance reveal that the FF do not follow the FS.

These results demonstrate that the influence of the gas temperatures variation (disturbance) plays an important part in gas turbine stability. Also, if the PID controller is used in the start-up and running of the gas turbine, a control is not performed satisfactorily because it cannot reduce many kinds of disturbances and at the same time cannot be tuned to follow the change of the various parameters of the gas turbine plant.

4.3. The Conventional 2-DOF PID Controller

Fig. 13 shows the response when applying the conventional 2-DOF-PID controller with gains (P=2.7, I=0.3, D=0.1, $\alpha=1.0$, $\beta=1.0$, $\gamma=1.0$) acquired by the Ziegler-Nichols method to a fuel loop feedback of the gas turbine

control system, without considering gas temperature disturbance.

From the starting point to the 12 second point, there are some problems with instability, but after the 12

second point, it follows the command of the controller signal.

However, Fig. 14, in the case of an application of different gain, shows that a fuel flow (FF) is following until the 10 second point, but from that point it has an opposite characteristic of Fig. 13.

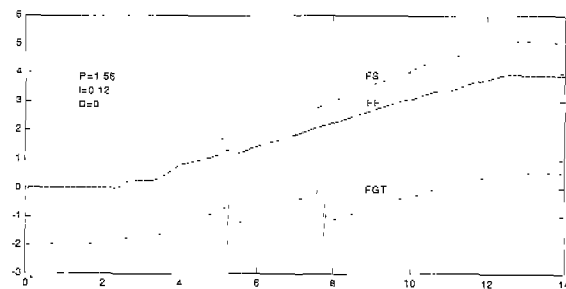

Fig. 12. Fuel loop feedback control by the PID controller in the event of a gas temperature disturbance (P=1.56, I=0.12, D=0.0).

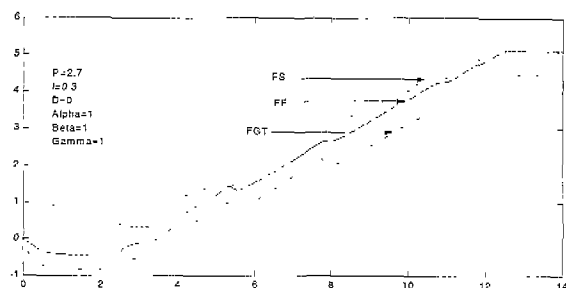

Fig. 13. Fuel loop feedback control by the conventional 2-DOF PID controller (P=2.7, I=0.3, D=0.1, $\alpha=1$, $\beta=1$, $\gamma=1$).

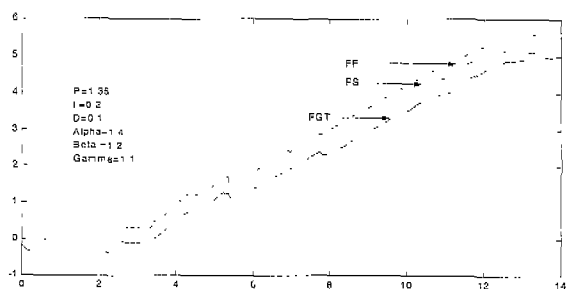

Fig. 14. Fuel loop feedback control by the conventional 2-DOF PID controller (P=1.35, I=0.2, D=0.1, $\alpha=1.4$, $\beta=1.2$, $\gamma=1.1$).

On the other hand, as Fig. 16 and Fig. 17 shows the experimental results in the fuel feedback loop with the disturbance from a change of gas temperature, it shows an unsatisfactory response. However, it is somewhat better

than the results of the PID controller. Especially, the FF does not go after the FS but the FGT. These results shows that the desired control can not achieved if the conventional 2-DOF-PID controller is used in the start-up and running of the gas turbine, as described in the PID

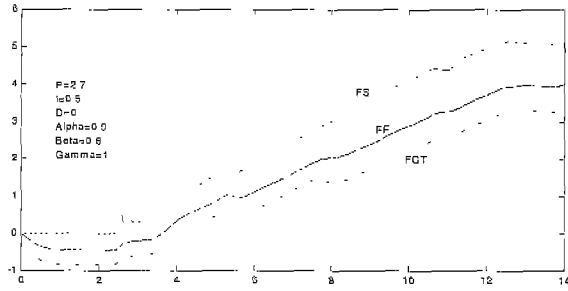

Fig. 15. Fuel loop feedback control by the conventional 2-DOF PID controller ($P=2.7$, $I=0.5$, $D=0.0$, $\alpha=0.9$, $\beta=0.6$, $\gamma=1.0$)

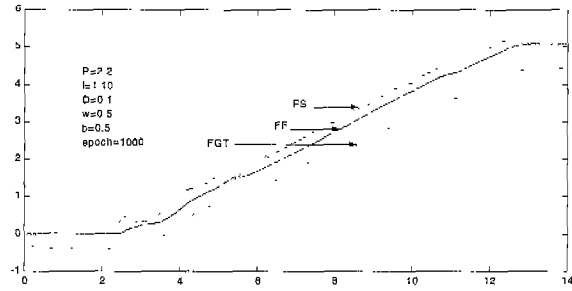

Fig. 19. Fuel loop feedback control by the NN-Tuning 2-DOF PID controller ($P=2.2$, $I=1.1$, $D=0.1$, $w=0.8$, $b=0.9$, epoch=1000).

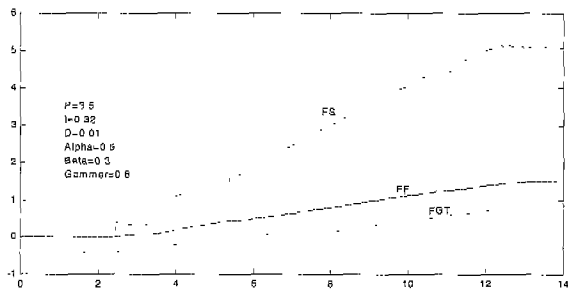

Fig. 16. Fuel loop feedback control by the conventional 2-DOF PID controller ($P=3.5$, $I=0.32$, $D=0.01$, $\alpha=0.5$, $\beta=0.3$, $\gamma=0.8$)

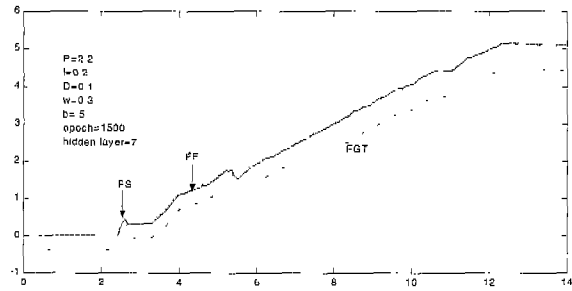

Fig. 20. Fuel loop feedback control by the NN-Tuning 2-DOF PID controller ($P=2.2$, $I=0.2$, $D=0.1$, $w=0.3$, $b=0.5$, epoch=1500, hidden=7).

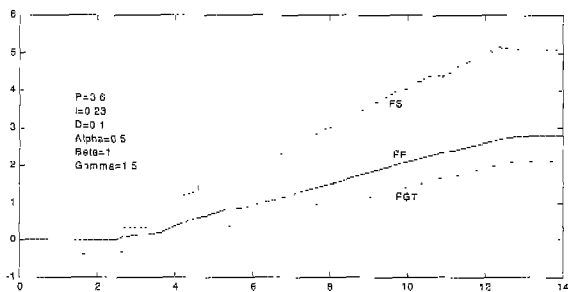

Fig. 17. Fuel loop feedback control by the conventional 2-DOF PID controller during the gas temperature disturbance ($P=3.5$, $I=0.32$, $D=0.01$, $\alpha=0.5$, $\beta=0.3$, $\gamma=0.8$)

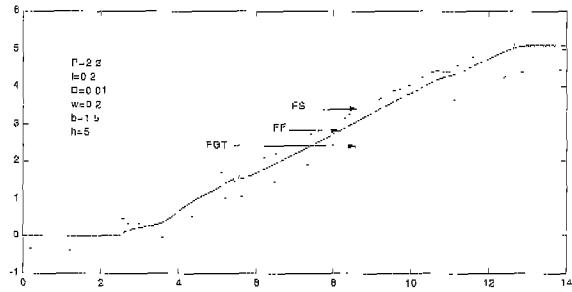

Fig. 21. Fuel loop feedback control by the NN-Tuning 2-DOF PID controller ($P=2.2$, $I=0.2$, $D=0.01$, $w=0.2$, $b=1.5$, $h=5$).

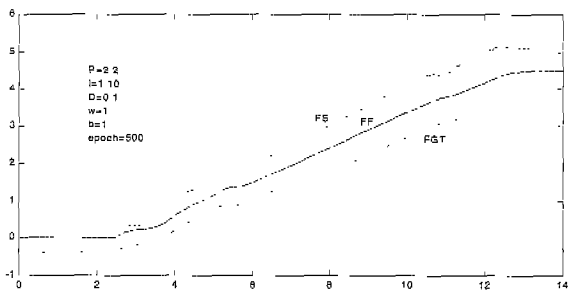

Fig. 18. Fuel loop feedback control by the NN-Tuning 2-DOF PID controller ($P=2.2$, $I=1.1$, $D=0.1$, $w=1$, $b=1$, epoch=500).

4.4. The NN-Tuning 2-DOF PID Controller in the Gun-san Gas Turbine Generating Plant

Figs. 18-30 illustrate the response achieved when applying a neural network based tuning 2-DOF PID controller (NN-Tuning 2-DOF-PID) to the Gun-san gas turbine control system.

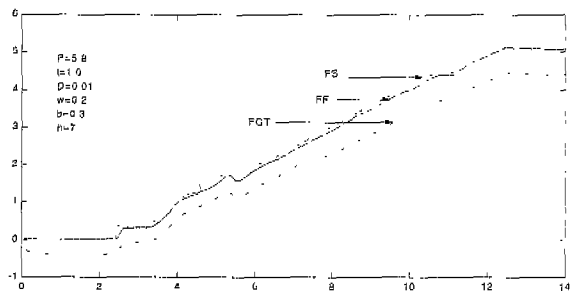

Fig. 22. Fuel loop feedback control by the NN-Tuning 2-DOF PID controller ($P=2.2$, $I=0.2$, $D=0.01$, $w=0.2$, $b=0.3$, $h=7$).

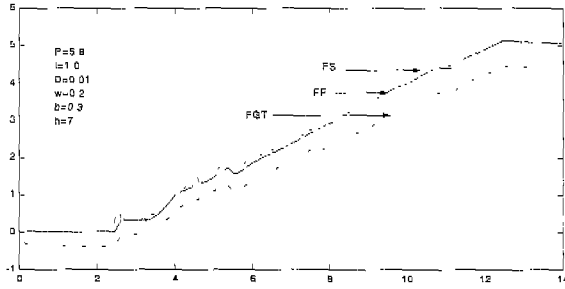

Fig. 23. Fuel loop feedback control by the NN-Tuning 2-DOF PID controller ($P=2.2$, $I=0.2$, $D=0.01$, $w=0.2$, $b=0.3$, $h=7$).

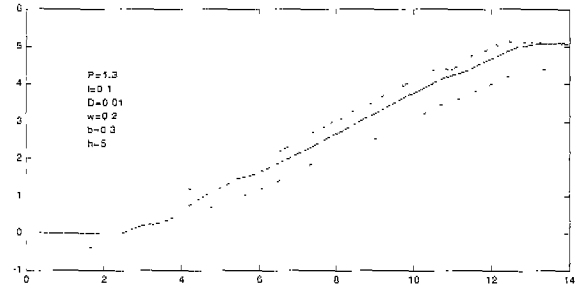

Fig. 27. Fuel loop feedback control by the NN-Tuning 2-DOF PID controller during a gas temperature disturbance ($P=2.2$, $I=0.2$, $D=0.01$, $w=1.0$, $b=1.5$, $h=5$).

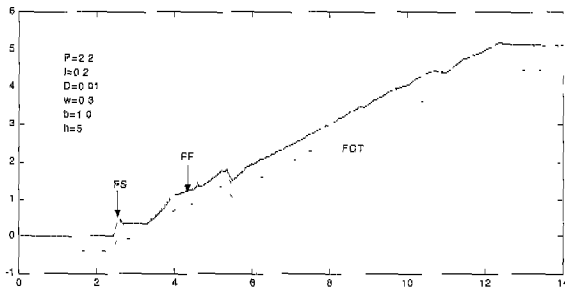

Fig. 24. Fuel loop feedback control by the NN-Tuning 2-DOF PID controller ($P=2.2$, $I=0.2$, $D=0.01$, $w=0.3$, $b=1.0$, $h=5$).

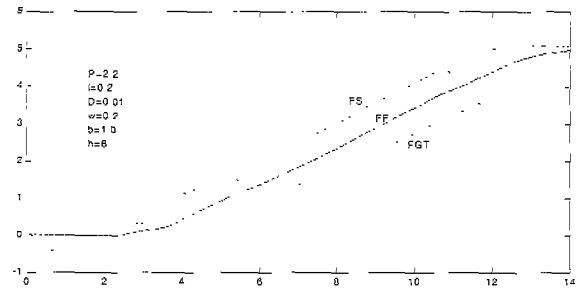

Fig. 28. Fuel loop feedback control by the NN-Tuning 2-DOF PID controller during a gas temperature disturbance ($P=2.2$, $I=0.2$, $D=0.01$, $w=0.2$, $b=1.0$, $h=8$).

As Figs. 18-24 reflect the response in the same fuel loop feedback control as the previous PID or the conventional 2-DOF PID controller, it shows that the actual flow comes after the command signal FS. If the hidden layer, weight, and bias are suitably tuned, an excellent result is achieved as in Fig. 20.

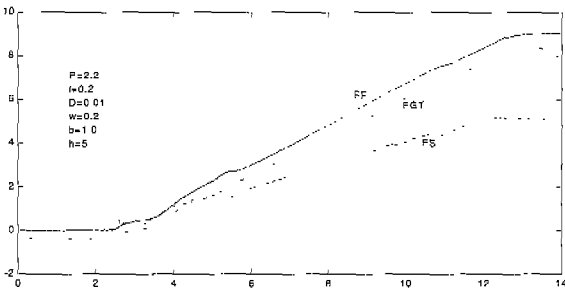

Fig. 25. Fuel loop feedback control by the NN-Tuning 2-DOF PID controller during a gas temperature disturbance ($P=2.2$, $I=0.2$, $D=0.01$, $w=0.2$, $b=1.0$, $h=5$).

The result of these figures means that even if the parameter value P, I, D change, or the plant is a system with a disturbance, the fuel flow can be controlled with stability. Fig. 20 shows that when applying the NN-Tuning 2-DOF PID to the Gun-san gas turbine temperature loop, all parameters have a stable response.

This means that the NN-Tuning 2-DOF PID controller that is proposed in this paper has a better characteristic against disturbance than the PID controller or the conventional 2-DOF PID controller.

On the other hand, Figs. 25-30 illustrate the response of the NN-Tuning 2-DOF PID controller during a gas temperature disturbance. When the number of hidden layers is 5, the best result is obtained, as in Fig. 30.

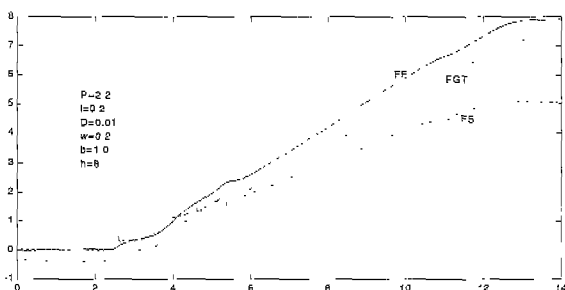

Fig. 26. Fuel loop feedback control by the NN-Tuning 2-DOF PID controller during a gas temperature disturbance ($P=2.2$, $I=0.2$, $D=0.01$, $w=0.2$, $b=1.0$, $h=8$).

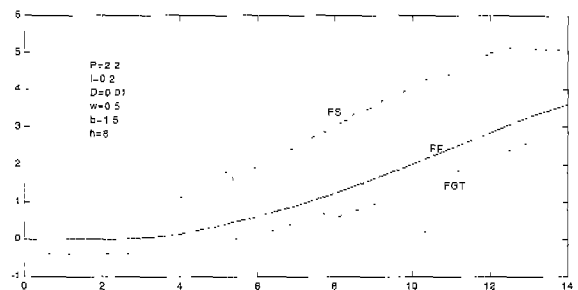

Fig. 29. Fuel loop feedback control by the NN-Tuning 2-DOF PID controller during a gas temperature disturbance ($P=2.2$, $I=0.2$, $D=0.01$, $w=0.5$, $b=1.5$, $h=8$).

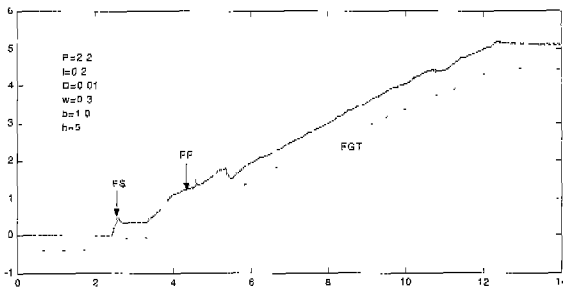

Fig. 30. Fuel loop feedback control by the NN-Tuning 2-DOF PID controller during a gas temperature disturbance ($P=2.2$, $I=0.2$, $D=0.01$, $w=0.3$, $b=1.0$, $h=5$).

V. Conclusion

A combined power generating plant with a gas turbine increases the efficiency of a power plant to about 50%, while the traditional steam turbine plant efficiency is approximately 35% to 40%. The gas turbine in power plants plays an important role in reducing losses of energy.

Up to this time, the PID controller has been used to operate gas turbines. However, it is very difficult for an operator to obtain an optimal gain without experience, since the gain of the PID controller has to be manually tuned by trial and error procedures.

In this paper, a 2-DOF PID controller with a combined two-degrees parameter for the Gun-san gas turbine in Korea, which is tuned by a neural network, has been studied through experiments. In order to design the actual controller for a gas turbine, the transfer function and the operating data from operating procedures (start-up, running, and stop procedures) have been acquired. The designed controller has been applied to this system. The results of the NN-Tuning 2-DOF PID are compared with the PID controller and the conventional 2-DOF PID controller tuned by the Ziegler-Nichols method. The experimental results reveal that the performance of the NN-Tuning 2-DOF PID controller has a more satisfactory response than that of the PID controller or the conventional 2-DOF PID controller tuned by the Ziegler and Nichols method.

References

- [1] J. A. Rovnak and R. Colis, "Dynamic matrix based control of fossil power plants", *IEEE Trans. On Energy Conversion*, vol. 6, no. 2, pp. 321-326. 1996.
- [2] A.W.Ordys, et al, "Modeling and simulation of power generation plants", Springer-Verlag, pp. 18-22, 1994.
- [3] W. W. Hung, "Dynamic simulation of gas-turbine generating unit", *IEE processing*, vol. 138, no. 4, pp. 342-350. 1991.
- [4] KEPO, "Gun-san gas turbine operating manual and system manual", 1975.
- [5] K. J. Astrom, "Automatic tuning of PID controllers", ISA, 1988.
- [6] K. Hiroi, "2-DOF PID controller", *SICE*, vol. 23, no. 9, pp. 889-895. 1988.
- [7] D. H. Kim, "An application of multivariable 2-DOF PID controller with neural network tuning method to the Heat exchange", *FUZZ-IEEE 99*, Seoul, Korea, Oct. 22-23, 1999.



Kim, Dong Hwa

He was born on Nov.15,1949 in Korea and received PhD in automatic control from Ahjou University. He has ever worked at Department of Instrumentation in KAERI (Korea Atomic Research Energy Institute) from 1978 to 1993. He has ever studied about nuclear electronic at AECL (Atomic Energy Canada Laboratory) as senior visiting research from 1985 to 1986, and has ever also researched about fuzzy system at University of Alberta in Canada as visiting professor from March 3, 2000. He has been working at Dept. of Instrumentation and Control in the Hanbat National University from March 1993. He is interesting in intelligent control in process. He has member in IEEE, ISA, IFSA, SICE, RSJ, JIEE, SOFT, INNS, KIEE, ICASE, KFIS, KIPE.