

Low Cycle Fatigue of PPS Polymer Injection Welds (II) — Fiber Orientation and Fracture Mechanism —

Jun Hee Song

Faculty of Mechanical Engineering, Research Institute of Industrial Technology, Chonbuk National University, 664-14 Iga, Duckjin-Dong, Duckjin-Gu, Chonju, Chonbuk 561-756, Korea

Jae Kyo Lim*

Faculty of Mechanical Engineering, Automobile Hi-Technology Research Institute, Chonbuk National University, 664-14 Iga, Duckjin-Dong, Duckjin-Gu, Chonju, Chonbuk, 561-756, Korea

The polymer composites contain numerous internal boundaries and its structural elements have different responses and different resistances under the same service environment. Fatigue phenomenon is much more complex in composites than homogeneous materials. An understanding of the fracture behavior of polymer composite materials subjected to constant and cyclic loading is necessary for predicting the life time of structures fabricated with polymers. There is a need to acquire a better understanding of the fatigue performance and failure mechanisms of composites under such conditions. Therefore, in this study the analyses of fiber orientation and fracture mechanism for low cycle fatigue crack have been studied by SEM and LM for observing the ultrathin sections.

Key Words : Polymer Composites, Fatigue Crack, Fiber Orientation, Fracture Mechanism, Polyphenylene Sulfide

1. Introduction

The polymer composites, especially glass fiber-filled polymer composites materials, are inhomogeneous by definition, they contain numerous internal boundaries which separate constituent materials that have different responses and different resistances to the long-term application of external influences (Lim, 2001). Therefore, fatigue as a phenomenon is much more complex in composites than it is for more familiar homogeneous materials. Many composite materials are also anisotropic. Hence, properties such as stiffness and strength becomes tensor arrays of independent

components of properties, each of which may change in a manner that is very different from that of the remaining components (Harik, 2000). Hence, in a fiber reinforced material the stiffness in the direction transverse to the fibers may change by a large amount during cyclic mechanical loading, whereas the stiffness in the direction of the fibers may be virtually unaffected (Attia, 2001; Jack, 2001).

An understanding of the fracture behavior of polymer composite materials subjected to constant and cyclic loading is necessary for predicting the life time of structures fabricated with polymers (Himmel, 2002). The fatigue behavior of thermoplastics has assumed increasing importance in recent years as these materials have become more widely used in load bearing applications. Thermoplastics are being used more and more often for applications where considerable loading is involved. There is thus a need to acquire a better understanding of the fatigue performance and failure mechanisms of these ma-

* Corresponding Author,

E-mail : jklim@moak.chonbuk.ac.kr

TEL : +82-63-270-2321; **FAX :** +82-63-270-2443

Faculty of Mechanical Engineering, Automobile Hi-Technology Research Institute, Chonbuk National University, 664-14 Iga, Duckjin-Dong, Duckjin-Gu, Chonju, Chonbuk 561-756, Korea. (Manuscript Received September 23, 2002; Revised March 21, 2003)

materials under such conditions (Song, 1998).

Therefore, in this study the analyses of fiber orientation and fracture mechanism for low cycle fatigue crack have been studied by scanning electron microscopy (SEM) and light transmission microscope (LM) for observing the ultrathin sections.

2. Experiments

2.1 Materials and specimen

The polymer composite material used in this experiment is polyphenylene sulfide (PPS) [C-1000SG] with crystalline structure as a super engineering plastics having 40 % short glass fiber

Table 1 Mechanical properties of PPS

Properties	Parent	Weld
Ultimate Strength (MPa)	144	65
Yielding Strength (MPa)	132	65
Elongation (%)	3.6	1.9
Tensile Modulus (MPa)	7056	3920
Hardness (HRB)	85	94

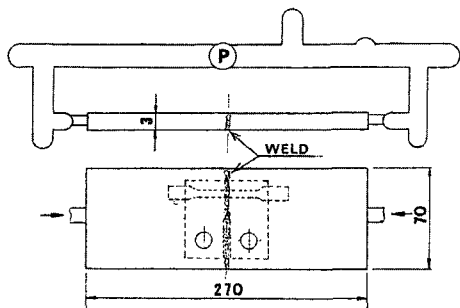

Fig. 1 Layout and dimensions of injection mold and specimens

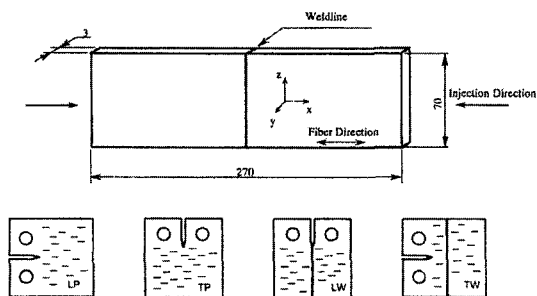

Fig. 2 Layout and dimensions of injection mold and extraction of CT specimen

content (Young, 2000). Mechanical properties are listed in Table 1. The diameter of the glass fiber is 13 μm and its length is 200~400 μm . As shown in Fig. 1, a double-gated mold was used in this study. It was for a compact tension (CT) specimen with a parent and weld line. Four kinds of CT specimen [i.e. LP(longitudinal parent), TP (transverse parent), LW(longitudinal weld line) and TW(transverse weld line)], as shown in Fig. 2, were machined from injection molded plate for fatigue test.

2.2 Fractography

The preparation of thin sections for transmitted light observation is best performed by microtoming techniques. Microtoming techniques (Bell, 1979) for slicing ultrathin sections from molded polymer parent and weld parts are emerging as important procedures for making an accurate microstructural analysis of fiber orientation within an injection-molded part. This kind of approach can provide the molder with information for failure analysis, part and mold design, and especially analysis of flow direction and processing optimization. The equipment needed for microtoming and sample preparation usually are available in the laboratory and can be used to prepare polymeric thin sections for microstructural examination using wheel cutter and polisher. These sliced sections should be polished as thin as possible to achieve maximum clarity for the microscopic analysis of fiber orientation at polymer injection weld parts. The specimen has been microtomed and polished in order with #200, #400, #800 sand paper with polisher. After that, it has been polished again with #2000, #3000 alumina powder on the glass plate by hand. Then, the section about 10~15 microns thick is prepared for microscopic observation. The sections produced by the microtoming techniques are cemented to glass slides for protection and easy observation.

For the visualization of fiber orientation, two different methods may be used ; LM and SEM. The principal piece of equipment required for microstructural analysis of plastics is a LM. It must have a polarizer and an analyzer for ob-

servicing the microstructures of crystalline polymers and stress concentrations. The light source may be either direct or reflective, and it is preferable to have one whose intensity can be varied. To ensure better contrasting of glass fibers, the LM-technique was proposed (Karger, 1988). Fiber orientations of PPS in the parent and weld material were observed by LM with the ultrathin 10~15 μm sections. Also, the fracture surfaces of the specimens were observed by SEM at an accelerating voltage of 10 kV. The specimen for observing the fracture surface was coated with an Au ion layer as is done for SEM observations. Such coating can reduce glare in the microscope as eliminating confusing internal reflections.

3. Results and Discussion

3.1 Microstructure of parent and weld material

There are many benefits of using short fibers as reinforcement for thermoplastic polymers, e.g., increase in elastic modulus and hardness, improved tensile strength, higher thermal stability, lower thermal expansion, better dimensional stability, increased fatigue resistance and easy processability by traditional shaping processes especially injection molding. Sometimes, however, an opposite trend in one or more of the above properties can also be found. It is rather difficult to predict which effect will be dominant. As shown in Fig. 3, a detailed characterization of the fiber morphology at the injection flow of PPS parent was obtained by means of LM from sheets at orientation parallel and perpendicular to the injection flow direction. Reinforcement such as glass fibers shows preferred orientations. To obtain maximum use of the glass fiber, they must flow into the part in the proper direction to solidify in the preferred orientation. When examining for flow and orientation, it is necessary to microtome the specimen parallel to the direction of flow. Figure 3(a-c) shows the picture of the PPS parent with parallel orientations of glass fiber relative to the injection flow direction. The orientation of short glass fiber is nearly the same direction as the injection flow, (a) and (c) show

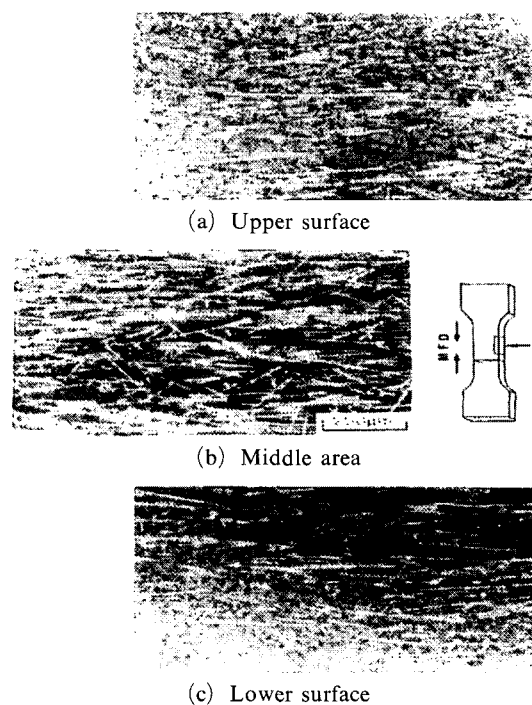

Fig. 3 Photomicrographs taken on fiber orientation in the parallel plane of injection molded PPS parent.

the fiber orientation at the upper surface and lower surface respectively, and they represent the changing orientation due to decreasing the viscosity at the matrix contacting the mold surface. So some of fibers near the surface change to perpendicular direction, and (b) is also the photography of the middle area, parallel to mold filled direction (MFD). The fiber orientation is parallel to MFD, but a few change the direction because changing the viscosity of matrix by the difference of temperature in mold.

It illustrates a typical microstructure of an injection molded short fiber reinforced polymer (SFRP) which exhibits mostly a three-layer laminate structure across the plaque thin thickness. It can be roughly subdivided into one central layer and two surface layers with fibers aligned in MFD. Fiber alignment in the surface layers can be explained by shear, while that in the central layer can be explained by mixing zone of the melt.

Figure 4(a, b) is the microstructure of PPS weld showing glass fiber flow in y - z plane. Flow

of the two directions comes together at one point and makes a weld line with the fiber orientation perpendicular to MFD. It shows the volcano-like mechanism which creates orientation at 90 angles to main flow direction. The mold thickness is 3 mm in y-z plane contrasted with the 13 mm width in x-z plane. So the flow front changes in the perpendicular direction only. Figure 4(a) shows the fiber pattern of the surface in the y-z plane and Fig. 4(b) shows the middle side. It is shown that the fiber flow always changes direction at the mold surface.

Figure 5(a, b) is the magnification photomicrographs showing the difference of the fiber orientation in the surface region (a) and the middle area (b) of PPS weld. The photomicrograph of the polished surface indicates clearly a high orientation of fibers in the MFD, while

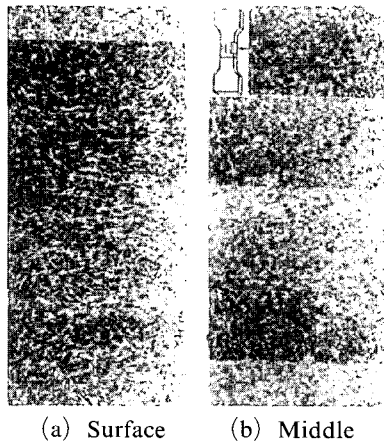

Fig. 4 Photomicrographs of volcano-like pattern of PPS weld in y-z plane

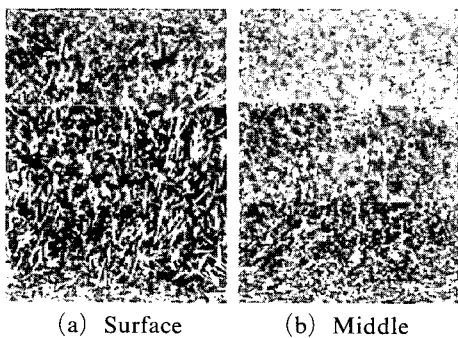

Fig. 5 Photomicrographs of volcano-like pattern of PPS weld magnified in y-z plane.

the surface shows a fiber orientation which is diagonal in the middle area or even perpendicular to the MFD in the surface region. PPS weld also includes volcano-like pattern (Lim, 1993) in weld line, but the type of fiber orientation is different in the surface and middle portions.

3.2 SEM observation of fracture surface

Figure 6 shows the macrophotograph of crack growth behavior at the direction of crack growth after fatigue testing. Fatigue crack of LP grows directly to the front of specimen. The others except LP are affected by the fiber orientation and weld line in front of the fatigue crack, and show the retardation of crack growth.

Figure 7 through Fig. 10 illustrate the fracture surface of LP, TP, LW and TP observed along with the crack length from the near notch tip to the end of ligament, that is, fatigue crack growth from the bottom to the top of this figure like arrow showing the crack growth direction. Figure 7 shows the fractography at surface and middle part of LP, the glass fiber of surface parts is parallel to the direction of crack growth, but that of the middle is perpendicular to the direction of crack growth.

Figure 8 shows that the fracture surface of TP, compared to the LP, changes the fiber orientation of the fracture surface at surface and middle parts.

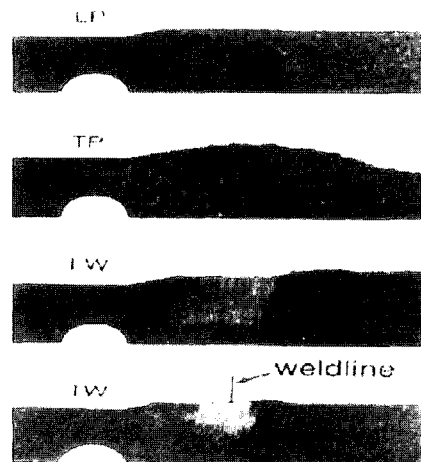

Fig. 6 Configuration of fatigue crack growth at PPS parent and weld

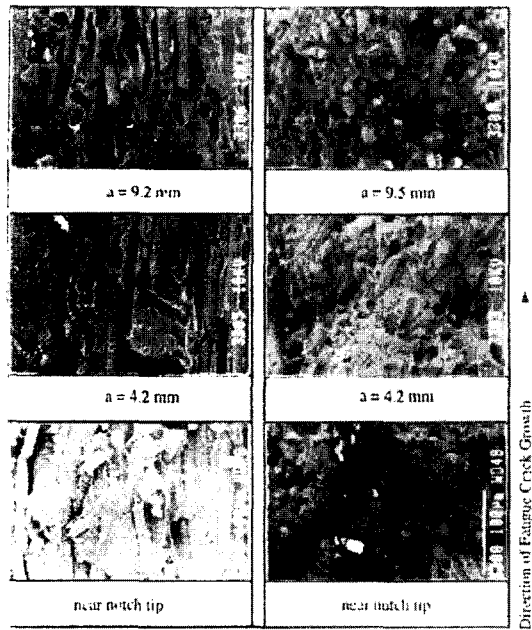

Fig. 7 Variation of fracture surface along the crack growth of PPS parent (LP)

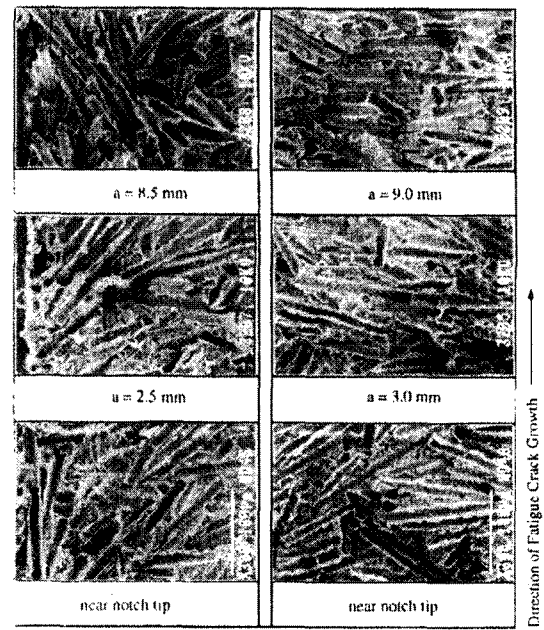

Fig. 9 Variation of fracture surface along the crack growth of PPS weld (LW)

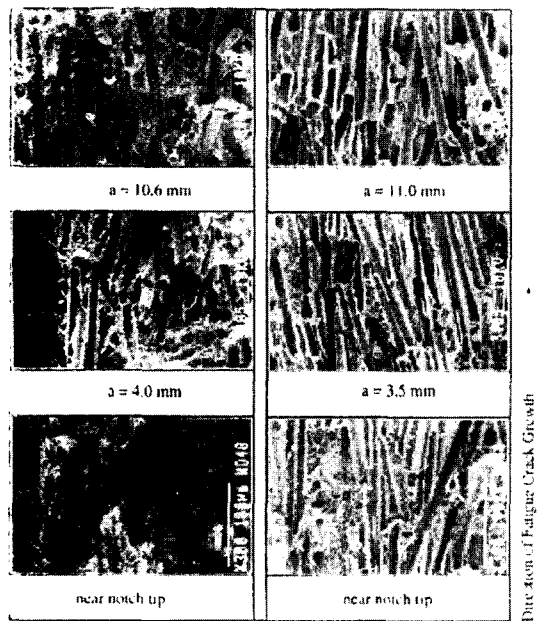

Fig. 8 Variation of fracture surface along the crack growth of PPS parent (TP)

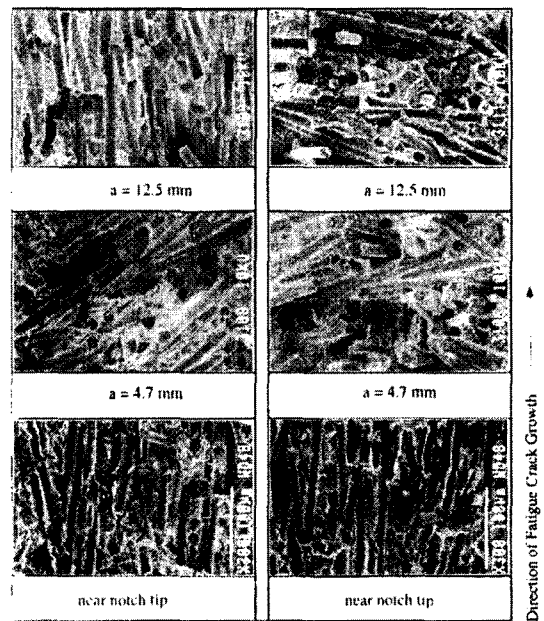

Fig. 10 Variation of fracture surface along the crack growth of PPS weld (TW)

Figure 9 shows that the fiber orientation at weld, LW, the middle part is perpendicular to the crack growth direction and change the fiber orientation near the surface, especially observe the

matrix film of 10 micro-meter thickness at the mold surface. This is the result of solidification rapidly in the mold surface due to difference of temperature of the mold and melt.

Figure 10 is the fracture surface of TW, the fiber orientation around the notch tip is parallel to the direction of crack growth, but change the fiber direction. It shows the weld line being distant 5 mm from the notch tip. This effect of fiber orientation and weld line retarded or accelerated the crack growth rate of polymer injection weld. The fiber orientation at injection mold is not oriented constantly due to internal flow of mold, but change the direction of fiber in the mold under some kinds of reason as follows. 1) The direction of fiber oriented constantly according to flow direction in case of high speed over the general flow speed, but the flow direction at low speed, fiber orientation at side of mold is parallel and is perpendicular to the direction of injection flow in the center of mold. 2) Fiber near to the weld line oriented parallel to the weld line.

3.3 Fatigue life and fatigue crack propagation mechanism

This section summarizes and compares the fatigue behavior of PPS parent and weld included short glass fiber in terms of the cycles to produce complete separation of unnotched loaded tensile specimen (Noda, 2001).

Figure 11 shows the relation between maximum cyclic stress and fatigue cycle of PPS parent and weld. Fatigue strength of parent is high, compared to weld.

Figure 12 shows the fractography at after fatigue loading and fractured at maximum cycle. Each kind of fracture surfaces represents the surface and center of PPS weld.

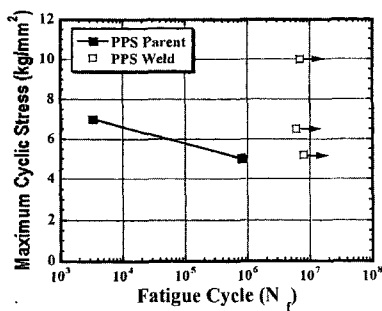

Fig. 11 Relation between maximum cyclic stress and fatigue cycle of PPS

Figures 13 and 14 show the matrix and fiber fractured micro structural to find the fracture and fatigue mechanisms growing to failure. Figure 13 is the fractography of matrix fractured due to stress concentration around the fiber in PPS weld and also seemed to grow the crack according to the striation showing at the metal fatigue. The origin of crack initiation is the interface of fiber and matrix. Fatigue energy concentrated and accumulated at this interface to the fracture energy

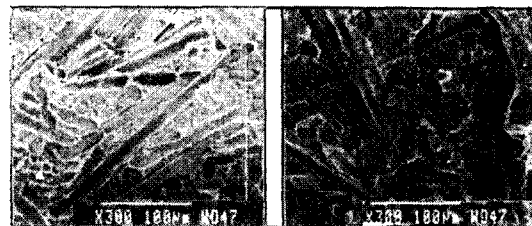

Fig. 12 Fractography of PPS weld after fatigue testing

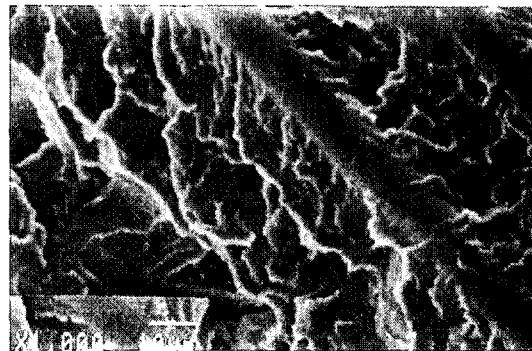

Fig. 13 Fatigue crack initiation and propagation of PPS weld at interface of fiber and matrix

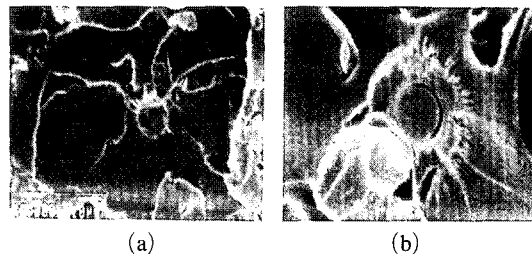

Fig. 14 Fatigue crack initiation and propagation at fiber parallel to the loading direction (a) crack growth behavior due to precrack of fiber (b) energy accumulation and hardening around fiber

initiates the crack at the boundary and propagates the crack rapidly to the next fiber, and the fatigue crack grows repeating the fatigue cycle continuously. Figure 14 shows the fracture appearance of glass fiber oriented parallel to the loading direction, namely, perpendicular to the direction of crack growth. Figure 14(a) shows the crack growth behavior due to precrack of fiber. Fatigue energy concentrates on the crack tip of fiber and propagates the crack through the matrix to the next fiber spreading like river pattern. So there is no clearance at the fiber and matrix. As shown in Fig. 14(b) the perfect fiber without the precrack is loaded at the fiber and matrix, so the fiber and matrix are fatigued and made a clearance in the interface of fiber and matrix because of the difference thermal conductivity and elastic modulus. And it initiates the crack around the fiber and propagate rapidly to circular direction. First circle of the matrix around fiber represents the crack initiated at same time with the fiber, and second circle represents the fatigue crack propagated by the energy accumulated at crack tip, which energy is not so much. The last circle of the matrix shows the crack propagation type like sun flower grown rapidly by the energy accumulated at the crack tip of matrix. So author named the fatigue crack, "sun flower type".

4. Summary

The summary derived from the experimental results on the microstructural characteristics and fatigue crack growth behaviors of PPS injection weld are summarized as follows.

(1) Typical microstructure of an injection molded short fiber reinforced polymer composites exhibits mostly a three-layer laminate structure across the plaque thin thickness, and roughly subdivides into one central layer and two surface layer with fibers aligned in MFD.

(2) The origin of fatigue crack initiation is the energy concentrated and accumulated with the interface of fiber and matrix at the composites with fiber oriented with some angle to the direction of tensile loading, and this type of crack growth behavior shows the striation type in the

matrix and propagate rapidly to the next fiber.

(3) There are two types of crack growth behaviors in polymer composite with fiber parallel to loading direction. The one is the type propagated directly and circularly from the fiber to the next fiber through the matrix at the interface of matrix and fiber without precrack at the fiber, and the fracture surface of fiber illustrates the hackle zone. But fatigue crack of the fiber and matrix without any damage in the fiber preliminary shows the circle type initiated and propagated, like sun flower type. The first step of fatigue crack growth is loaded and fatigued at the fiber and matrix same time, and makes a clearance in the interface of fiber and matrix, the second step is initiated the crack around the fiber and propagated rapidly to circular direction with three circles of crack propagation type.

References

- Attia, O., Kinloch, A. J. and Matthews, F. L., 2001, "Modelling the Fatigue Life of Polymer-Matrix Fibre-Composite Components," *Composites Science and Technology*, Vol. 61, No. 15, pp. 2273~2283.
- Bell, G. R., Cook, D. C. and Rogers, D. D., 1979, "Microtoming ; An Emerging Tool for Analyzing Polymer Structures," *Plast. Eng.*, No. 35, pp. 18.
- Harik, V. M., 2000, "Low Cycle Fatigue of Unidirectional Laminates : Stress Ratio Effects," *Journal of Engineering Materials and Technology*, Vol. 122, No. 4, pp. 415~419.
- Himmel, N., 2002, "Fatigue Life Prediction of Laminated Polymer Matrix Composites," *International Journal of Fatigue*, Vol. 24, No. 2, pp. 349~360.
- Jack, R. V. and Eyassu Woldesenbet, 2001, "Fiber Orientation Effects on High Strain Rate Properties of Graphite/Epoxy Composites," *Journal of Composite Materials*, Vol. 35, No. 6, pp. 509~521.
- Karger, K. J. and Friedrich, K., 1988, *Advancing with Composites Conf.*, Milan, pp. 639.
- Lim, J. K. and Kim, Y. J., 1993, "A Study on Fatigue Properties of GFRP in Synthetic Sea

Water," *Trans. of KSME*, Vol. 17, No. 6, pp. 1351~1360.

Lim, J. K. and Kim, Y. J., 2001, "Evaluation of Inhomogeneous Deformation and Stress Concentration in Polymer Composites Injection Weld by means of Thermoelastic Techniques," *KSME International Journal*, Vol. 15, No. 12, pp. 1616~1622.

Noda, K., Takahara, A. and Kajiyama, T., 2001, "Fatigue Failure Mechanisms of Short Glass-Fiber Reinforced Nylon 66 Based on Non-linear Dynamic Viscoelastic Measurement," *Po-*

lymer, Vol. 42, pp. 5803~5811.

Song, D. Y. and Otani, N., 1998, "Approximate Estimation of Fatigue Strength of Polymer Matrix Composites by Material Properties," *Materials Science and Engineering A*, Vol. 254, No. 1, pp. 200~206.

Young, R. T. and Baird, D. G., 2000, "The Influence of Processing Variables on Injection Molded in Situ Composites Based on Polyphenylene Sulfide and a Melt Processable Glass," *Composites Part B : Engineering*, Vol. 31, pp. 209~221.