

Verification of the Theoretical Model for Analyzing Dynamic Behavior of the PIG from Actual Pigging

Dong Kyu Kim*, Sung Ho Cho, Seoung Soo Park, Yong Woo Rho, Hui Ryong Yoo

Korea Gas Corporation (KOGAS), 638-1, Il-dong, Ansan, 425-150, Korea

Tan Tien Nguyen

Department of Mechanical Eng., Hochiminh City University of Technology,

268 Ly Thuong Kiet Str., Dist. 1, Hochiminh City, Vietnam

Sang Bong Kim

Department of Mechanical Eng., College of Eng., Pukyong National University,

San 100, Yongdang-dong, Nam-gu, Pusan 608-739, Korea

This paper deals with verification of the theoretical model for dynamic behavior of Pipeline Inspection Gauge (PIG) traveling through high pressure natural gas pipeline. The dynamic behavior of the PIG depends on the differential pressure across its body. This differential pressure is generated by injected gas flow behind the tail of the PIG and expelled gas flow in front of its nose. To analyze the dynamic behavior characteristics such as gas flow in pipeline, and the PIG position and velocity, not only the mathematical models are derived, but also the theoretical models must be certified by actual pigging experiment. But there is not any found results of research on the experimental certification for dynamic behavior of the PIG. The reason is why the fabrication of the PIG as well as, a field application are very difficult. In this research, the effectiveness of the introduced solution using the method of characteristics (MOC) was certified through field application. In-line inspection tool, 30" geometry PIG, was fabricated and actual pigging was carried out at the pipeline segment in Korea Gas Corporation (KOGAS) high pressure system, Incheon LT(LNG Terminal)-Namdong GS(Governor Station) line. Pigging is fulfilled successfully. Comparison of simulation results with experimental results show that the derived mathematical models and the proposed computational schemes are effective for predicting the position and velocity of the PIG with a given operational conditions of pipeline.

Key Words : Pipeline Inspection Gauge (PIG), Method Of Characteristics (MOC), Geometry PIG

Nomenclature

A : Pipe cross-section area [m²]

C : Linear damping coefficient of PIG [Ns/m]

C_c : Convection heat transfer coefficient [W/m²K]

d : Internal diameter of pipe [m]

d_{valve} : Bypass valve diameter [m]

F_f : Friction force per unit pipe length [N/m]

F_{fp} : Friction force between PIG and pipe wall [N]

F_{fpdyn} : Dynamic friction force between PIG and pipe wall [N]

F_{fpsta} : Static friction force between PIG and pipe wall [N]

F_p : Force due to differential pressure acting on the PIG [N]

g : Gravity acceleration [m/s²]

k : Pipe wall roughness [m]

* Corresponding Author,

E-mail : giberdong@kogas.re.kr

TEL : +82-31-400-7474; **FAX :** +82-31-416-9014

Korea Gas Corporation (KOGAS), 638-1, Il-dong, Ansan, 425-150, Korea. (Manuscript Received April 9, 2002; Revised June 12, 2003)

K	: Wear factor of PIG [N/m]
K_{SE}	: Sudden expansion loss coefficient
K_{total}	: Total loss coefficient of bypass system
K_v	: Average-loss coefficient of valve
L	: Length of pipeline [m]
L_{PIG}	: Length of PIG [m]
M	: Weight of PIG [kg]
p	: Flow pressure [N/m ²]
q	: Compound rate of heat inflow per unit area of pipe wall [W/m ²]
Q	: Flow rate [m ³ /s]
S	: Perimeter of pipe [m]
T	: Flow temperature [K]
T_{ext}	: Seabed temperature [K]
u	: Flow velocity [m/s]
v_{ref}	: Reference velocity of PIG [m/s]
v_v	: Bypass flow velocity [m/s]

Greeks

γ	: Ratio of specific heat
β	: Angle between PIG velocity and gravity force [rad]
ν	: Kinetic viscosity of flow [m ² /s]
ρ	: Flow density [kg/m ³]

Subscripts

O, L	: denote the points at the inlet and outlet of pipeline
u, d	: denote the values of upstream and downstream flows

1. Introduction

The structural failure of a pipeline may result in environmental damage and financial losses. Regular monitoring of pipeline can forecast some failure modes and help plan maintenance (Azvedo et al., 1996). A pipeline can fail for different reasons which are related to deformation if we interpret deformation in a wide sense. The most common ruptures are caused by a physical damage, change of curvature or length of a pipeline, and by pipe wall corrosion. The damaging is usually external (Cordell and Vanzant, 1999). To prevent above problems, the pipeline must be pigged regularly. The tool used for pigging is called Pipeline Inspection Gauge (PIG). The PIG is a device which is inserted into a pipeline

and travels throughout the pipeline to be inspected. It provides geometric informations like curvature and slope, and pipeline anomalies like welds, dents, wrinkles, and corrosion. The information from pigging is the most effective when it runs at a constant speed but will not be effective when it runs at too high speed. The typical speeds for pigging are about 1-5 m/s for on-stream liquids and 2-7 m/s for on-stream gas (Cordell and Vanzant, 1999). In particular, when pigging low pressure lines, the PIG will hold up at a weld bead or other obstruction until the pressure builds up behind it sufficiently to overcome the obstacle. It then accelerates away—often attaining speeds of well over 26[m/s] before rest once more and repeating this cycle. This not only results in negligible pigging efficiency, but also highly dangerous situation (Tiratsoo, 1992). Therefore, estimating the PIG dynamics before choosing an operational condition and control of the PIG velocity would be of great interest to research when operating the pigging procedure in a pipeline.

To understand the dynamic behavior of the PIG, the governing nonlinear hyperbolic partial differential equations of flow must be solved together with the PIG dynamic equation. Results of research on the motion of the PIG in pipeline are scarcely found in the literature. There is the fact that most of research results give much commercial information more than necessary technical information about pigging process with exception of Nguyen's work (Nguyen et al., 2001). They deal with the PIG dynamic problem in more detail when it moves under several operational conditions of the pipeline. The theoretical model for the PIG dynamics was derived and the computational scheme using MOC (Method Of Characteristics) was proposed. Although the reliability and accuracy of the proposed solution using MOC was certified through only simulation results because fabrication of the PIG as well as, a field application is very difficult. Therefore, the actual pigging is necessary for verifying the reliability of solution. In this research, the reliability and accuracy of the introduced solution using MOC was verified through field application. For

actual pigging, 30" geometry PIG was developed. Although, the operation of the PIG is not easy, specially it is the first attempt in Republic of Korea. Also, actual pigging burdens the operator with a finite risk that the PIG body inserted into the pipeline may become lodged, block the flow. In spite of these difficulties, the PIG was adopted adventurously at the pipeline segments in Korea Gas Corporation high pressure system, from Incheon LT to Namdong GS, 13 km length. Actual pigging was carried out very successfully by so many person who attend at the experiment and the other operation technology which was not mentioned in here such tracking the PIG, and launching and receiving the PIG. Comparison of the simulation results with successful experiment show that the solution for PIG dynamics problem by using MOC with the proposed computational scheme is efficient with appropriate small sampling time and distance sufficiently.

2. System Modeling

The scheme of PIG flow in pipeline is given in Fig. 1. The PIG is driven by injected gas flow behind its tail (upstream flow) and expelled gas flow in front of its nose (downstream flow). The driving force, $F_p(t)$ is obtained by differential force between the tail and the nose of the PIG in Fig. 1, the PIG moves to overcome the friction force, $F_{fp}(t)$ and gravity weight, Mg .

2.1 Gas flow model

We assume the followings ;

- (1) natural gas is ideal,
- (2) flow is one phase,

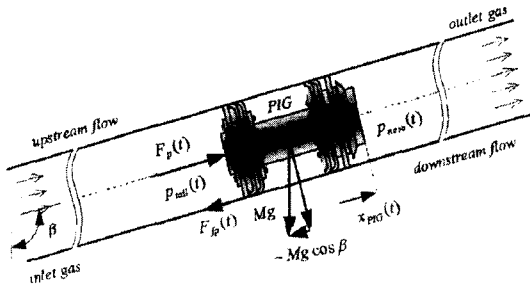

Fig. 1 PIG flow in the natural gas pipeline

(3) pipeline diameter is constant,

(4) friction factor is a function of wall roughness and Reynolds number ; steady state values are used in transient calculations,

(5) flow is quasi-steady heat flow.

The unsteady flow dynamics can be modeled based on four fundamental fluid dynamic equations ; continuity equation, momentum equation, state equation, and energy equation. These equations are rewritten as follows ;

$$\frac{\partial \rho}{\partial t} + \rho \frac{\partial u}{\partial x} + u \frac{\partial \rho}{\partial x} = 0 \quad (1)$$

$$\frac{\partial u}{\partial t} + \frac{1}{\rho} \frac{\partial p}{\partial x} + u \frac{\partial u}{\partial x} = -\frac{F_f}{\rho A} + g \cos \beta \quad (2)$$

$$\frac{\partial p}{\partial t} + u \frac{\partial p}{\partial x} + \gamma p \frac{\partial p}{\partial x} = \frac{\gamma - 1}{A} [(F_f - A \rho g \cos \beta) u + q_s] \quad (3)$$

The above equations are used to describe both upstream and downstream flows. These equations can be rewritten in the following forms respectively.

$$\frac{dX_u}{dt} + A_u \frac{dX_u}{dx} = B_u, \quad 0 \leq x \leq x_{PIG} - L_{PIG} \quad \text{and} \quad (4)$$

$$\frac{dX_d}{dt} + A_d \frac{dX_d}{dx} = B_d, \quad x_{PIG} \leq x \leq L \quad (5)$$

where

$$X_* = [\rho_* \quad u_* \quad p_*]^T$$

$$A_* = \begin{bmatrix} u_* & \rho_* & 0 \\ 0 & u_* & \frac{1}{\rho_*} \\ 0 & \gamma p_* & u \end{bmatrix}$$

$$B_* = \begin{bmatrix} 0 \\ -\frac{F_f}{\rho_* A} + g \cos \beta \\ \frac{\gamma - 1}{A} [(F_f - A \rho_* g \cos \beta) u_* + q_* S] \end{bmatrix}$$

* denotes u for upstream flow and d for downstream flow. Eqs. (4) and (5) must satisfy some boundary conditions, which will be described in next section.

Four nonlinear hyperbolic partial differential equations can be transformed to the ordinary differential equations by using MOC in the following forms.

$$\frac{du}{dt} + \frac{c}{\gamma p} \frac{dP}{dt} = E_1 \quad \text{along} \quad \frac{dx}{dt} = u + c \quad (6)$$

$$\frac{du}{dt} - \frac{c}{\gamma p} \frac{dP}{dt} = E_2 \quad \text{along} \quad \frac{dx}{dt} = u - c \quad (7)$$

$$\frac{dp}{dt} - c^2 \frac{d\rho}{dt} = E_3 \quad \text{along} \quad \frac{dx}{dt} = u \quad (8)$$

where

$$E_1 = \frac{\gamma-1}{c} \frac{q}{\rho m} + \left(\frac{F_f}{\rho A} - g \cos \beta \right) \left(\frac{\gamma-1}{c} u - 1 \right) \quad (9)$$

$$E_2 = \frac{\gamma-1}{c} \frac{q}{\rho m} - \left(\frac{F_f}{\rho A} - g \cos \beta \right) \left(\frac{\gamma-1}{c} u + 1 \right) \quad (10)$$

$$E_3 = (\gamma-1) \frac{q}{m} + \left(\frac{F_f}{\rho A} - g \cos \beta \right) (\gamma-1) u \rho \quad (11)$$

$$c = \sqrt{\gamma p / \rho}$$

$$m = A/S \quad (12)$$

$$F_f = F_f(k, Re)$$

The value of friction force, F_f , can be calculated as shown in the reference (Nguyen et al., 2001). The mathematical description of the heat rate term, q , in the above equations depends on the problem assumptions. Because there is no heat producing in flow, q could be evaluated as a quasi-steady heat transfer from the surrounding environment to the gas :

$$q = C_c (T_{ext} - T) \quad (13)$$

The flow variables ρ , u or p must be solved at each location x and time t . The sampling distance, Δx , and the sampling time, Δt , are chosen under the CFL stability constraint (Sim et al., 1997):

$$\Delta t < \left| \frac{\Delta x}{u \pm c} \right| \quad (14)$$

It is assumed that the steady state distributions are used for the initial conditions in the absence of field data concerning the initial field distributions (Wylie et al., 1993). The boundary conditions at pipeline inlet and outlet can be given in two way ; under a condition of flow rate $Q(t)$ or pressure $p(t)$ together with the temperature of flow $T(t)$. The detailed information is given in the previous work (Nguyen et al., 2001).

2.2 The PIG dynamics model

Forces acting on the PIG are described as

shown in Fig. 1. The dynamic equation of the PIG derived from the Newton's Second Law is as follows ;

$$M \frac{d^2 x_{PIG}(t)}{dt^2} + C \frac{dx_{PIG}(t)}{dt} + K x_{PIG}(t) \quad (15) \\ = F_p(t) - F_{fp}(t) + Mg \cos \beta$$

In Eq. (17), the driving force $F_p(t)$ is from the differential pressure between the tail and the nose of the PIG that are calculated from upstream and downstream flow dynamics. The friction force F_{fp} between the PIG and pipeline wall is assumed to be constant including static and dynamic friction forces. The wear factor K includes static wear factor and dynamic wear factor. The values of K , the linear damping coefficient, C , and F_{fp} are measured from the experiment.

The whole system dynamics include flow dynamics, Eqs. (4) ~ (5), and PIG dynamic, Eq. (15). The nonlinear hyperbolic partial differential Eqs. (4) ~ (5) with the boundary conditions can be solved by transforming them to ordinary differential equations using the method of characteristic that is presented in the previous works (Nguyen et al., 2001).

3. PIG (Pipeline Inspection Gauge)

3.1 System hardware description

The PIG is designed to meet a large variety of user requirements using a modular system which integrates a variable number of different sensors. It is equipped with IMU (Inertial Measurement Unit), caliper sensors, odometer sensors, and tracking transmitter. It is suspended in the pipeline on urethane disks at the front and rear of the canister, which allow the PIG to move close to and paralleled to the pipe centerline. The scheme of the PIG is shown in Fig. 2.

In this study, only odometer sensors and DAU (Data Acquisition Unit) are mentioned. The PIG is equipped with spring-mounted odometers. They are in constant contact to the pipe wall by spring tension. When the PIG travels through interior to the pipeline, gear-tooth of odometers are counted by hall-effect adaptive gear-tooth sensors. Fabricated odometers are shown in Fig. 3.

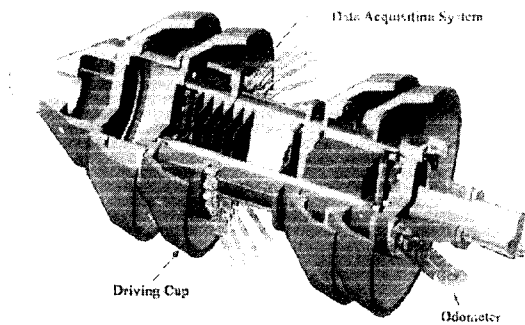

Fig. 2 Scheme of the PIG

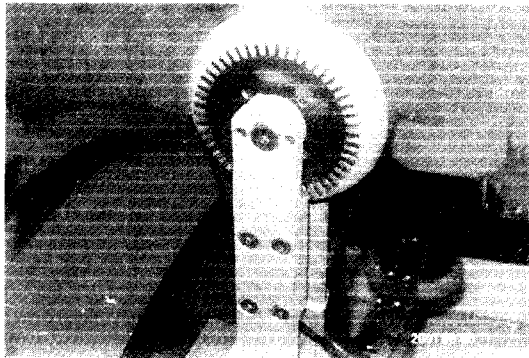

Fig. 3 Odometer wheels

The odometers measures the distance along the pipe and velocity of the PIG is derived from these information. Because velocity is used to collect the data, high accuracy is required. In this case, an accuracy of 0.05% can be obtained in a run time.

DAU recording to acquire the information is composed of embedded board (Celeron 366 MHz), interface board which is based on 16 bit micro-processor (80C296SA), and DAT (Digital Audio Tape), 20 Gigabytes capacity. This unit interfaces with bus types such as SCSI, ISA, and PCI, and communicates with Ethernet and serial port. Other principal components integrated in the PIG are lithium batteries, power management module and PIG tracking transmitter which can keep tracking the tool while it travels through the pipeline.

3.2 Data processing

DAU gathers the data of 24 mechanical fingers from an A/D conversion, and takes the data of 3 odometers from EPA function at a rate of 400 Hz.

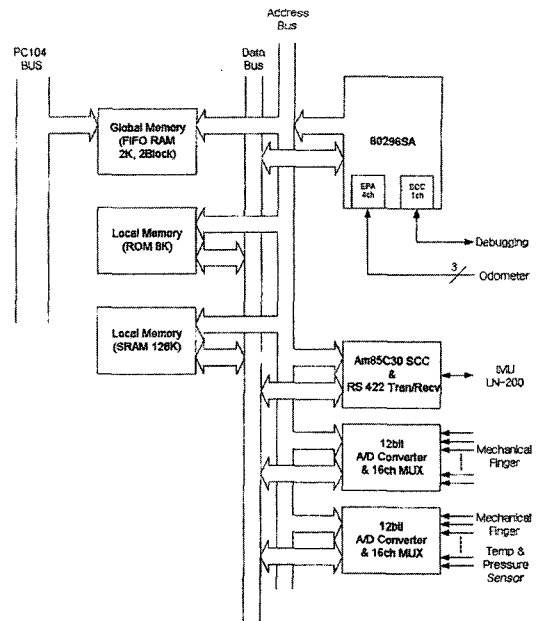

Fig. 4 Schematic diagram of DAU

The gathered data are saved in the dual port memory which is shared by the embedded board and interface board with ISA. The schematic diagram of DAU is shown in Fig. 4.

4. Simulation and Experimental Results

4.1 Actual pigging

The experiment was fulfilled one pipeline segment in the KOGAS high pressure system, Incheon LT-Namdong GS line. The main characteristics of the pipeline are summarized below.

Operating condition which was controlled by Central Control Center of KOGAS was the following.

The PIG was injected into the launcher by a truck as shown in Photo 1. The PIG was installed with a lead cup firmly in contact with the reducer between the barrel and the nominal bore section of the trap. After then, the safety valve was installed to lock on the closure, and a natural gas was filled in the trap barrel and in nominal bore section of the trap. Pressure in the tail of the PIG was changed by these procedures. The PIG traveled from Incheon LT to Namdong GS and

Table 1 Characteristics of pipelines

Pipeline segments	Incheon LT~ Namdong GS
Characteristics	
Nominal diameter	30"
Year of construction	1997
Length	13 km
Type of pipes	Longitudinally Welded
Maximum allowable operating pressure	100 bars

Table 2 Operating conditions

Pipeline segments	Incheon LT~ Namdong GS
Conditions	
Flow rate	520 ton/hr
Inlet pressure	58 bar
Flow velocity	3.5 m/s
Flow temperature	0-5 °C
Update points interval	800 m



Photo 1 Injecting the PIG into the pipeline

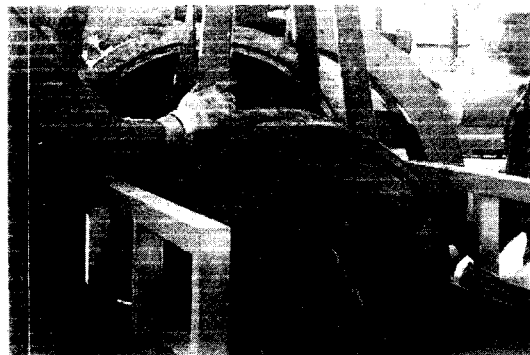

Photo 2 Removing the PIG from the Receiver

Table 3 The numerical values for simulation

Parameters	Values	Units	Parameters	Values	Units
L	13,000	m	ν	1.45×10^{-5}	m^2/s
D	0.7366	m	R	518.3	J/kgK
K	0.0450	mm	γ	1.40	
C_c	2	W/m^2s	M	600	kg
T_{ext}	15	°C	C	0.74	Ns/m
p_0	59	bar	K	0.00	N/m
Q_0	1.37	m^3/s	L_{PIG}	1.4	m
ρ_0	105.45	kg/m^3	F_{psta}	1.00	bar
p_L	57.95	Bar	F_{pdm}	0.11	bar
Q_L	1.37	m^3/s	T	5	°C
ρ_L	105.45	kg/m^3	β	0.00	rad

arrived in trap barrel of the receiver successfully. Photo 2 shows the receiver of the PIG in Namdong. Arrived PIG was removed from the receiver by receiving procedures (Cordell and Vanzant, 1999).

4.2 Simulation

Simulation was performed with applied pigging line. The numerical values used in this simulation are given in Table 3.

We choose the sampling time $\Delta t = 0.01$ s and the sampling distance $\Delta x = 8$ m. The boundary conditions of interest are used; constant flow rate at pipeline inlet $u_0(t, 0) = u_0$ and constant pressure at pipeline outlet $p_L(t, L) = p_L$.

4.3 Comparison between simulation with experiment

In order to improve reliability of the proposed solution, the essential factors in the PIG dynamics, pressure and velocity are compared between simulation and experiment. Although, it is very difficult to equip the differential pressure sensor because of the problem in structure of the PIG. To equip the PIG with the sensor, the flange which divides the upstream with downstream flow has to be mounted. If mounting of the sensor becomes loose, the pressure behind the PIG will be bypassed in front of the PIG. Then the PIG body introduced into the pipeline may become lodged and block the flow. Owing to these reason,

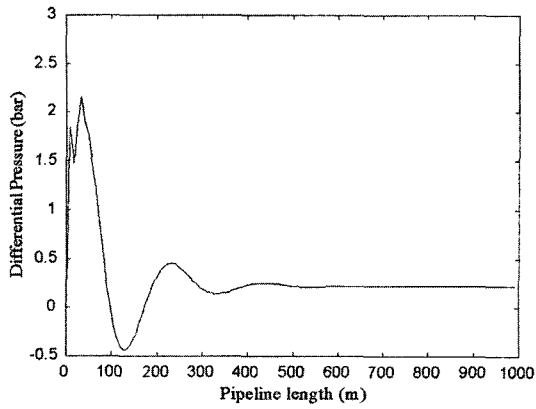

Fig. 5 Differential pressure of the PIG in the inlet pipeline

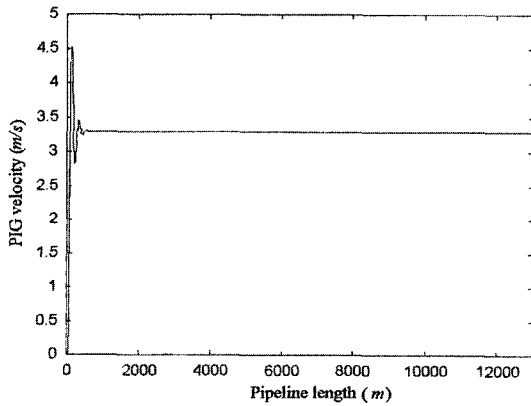

Fig. 6 Simulation velocity of the PIG in the pipeline, 13 km length

the sensor can not be installed in the PIG body. Therefore only comparison between simulation and experiment with respect to the velocity was considered in this research.

Once natural gas is injected into the launcher, pressure increases at its tail and decreases at its nose. Also the PIG accelerates until the differential pressure abates to a level required to overcome static and dynamic friction. Simulation results for the operating conditions in Table 2 is shown in Figs. 5~6. Figure 5 shows the differential pressure through the PIG body and Fig. 6 shows the velocity of the PIG in pigging line, 13 km length. From these results, we can know that the differential pressure is increased up to two bars to overcome the static friction force and differential pressure of 0.1 bars which acts on the

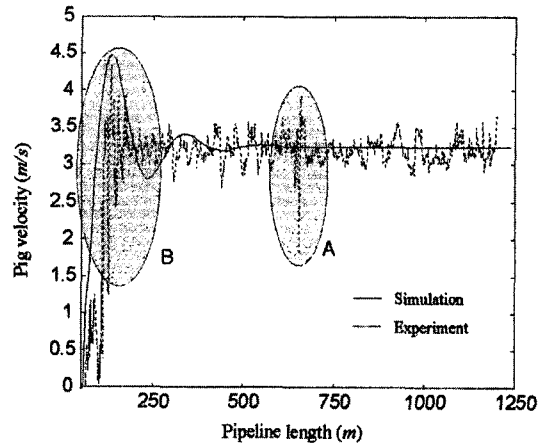

Fig. 7 Simulation and experimental results for PIG in the inlet pipeline

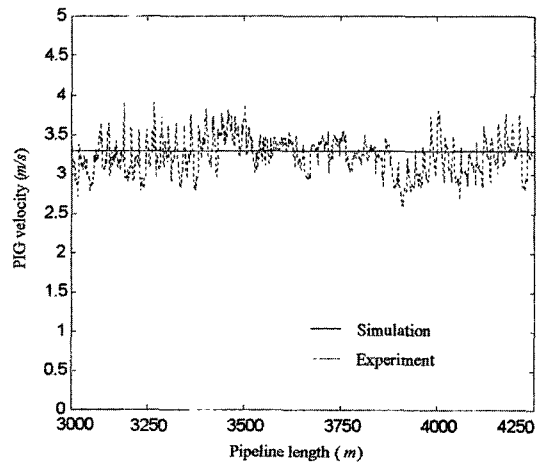

Fig. 8 Simulation and experimental results from 3 km to 4.25 km

PIG when it travels in the pipeline. Also, it is known for the PIG to move at about 3.4 m/s velocity in pigging line. Figure 7 expresses both the simulation and experimental results of the PIG in inlet pipeline section, 1 km length. The velocity of the PIG is decreased substantially in A area. The reason is that there is curved section. Other components such as valves, tees, and curved section in inlet pipeline results in decrease of the velocity in B area. But actual velocity of the PIG, expressed as the dotted line in Fig. 7, is similar to the trend of simulation velocity although it has a variation in A, B areas. In particular, the maximum velocities of simulation and experiment are

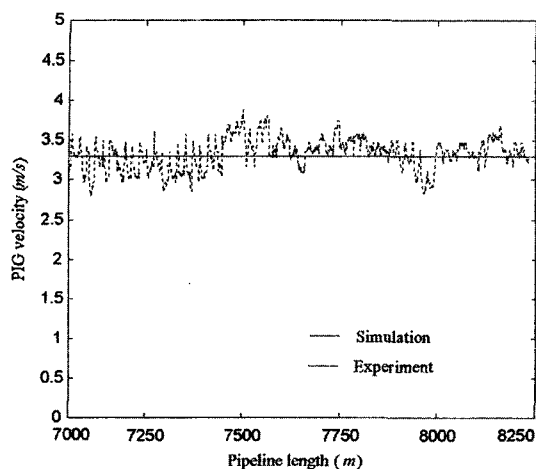

Fig. 9 Simulation and experimental results from 7 km to 8.25 km

almost the same when the PIG overcomes the static and dynamic friction. Figures. 8 and 9 show that the simulation and experimental results of the PIG at pipeline section of 3 km and 7 km, respectively.

5. Conclusion

This study verified the reliability and accuracy of the introduced solution using the method of characteristics through a field application. 30" geometry PIG was produced for actual pigging. The operation of the PIG is not easy, specially it is the first attempt in Republic of Korea. Also, actual pigging burdens the operator with heavy operating expense and there is always a finite risk that a foreign body introduced into the pipeline will become lodged, block the flow. In spite of these difficulties, the geometry PIG was adopted adventurously at the pipeline segments in Korea Gas Corporation high pressure system, from Incheon LT to Namdong GS, 13 km length. Actual pigging was fulfilled excellently by incorporating with operational technology of the PIG. Comparisons between simulation and experiment show that the derived theoretical models and the proposed computational schemes are effective for predicting the position and velocity of the PIG for a given operational conditions of the pipeline. This approach is quite efficient for modeling the

rapid flow transient and the PIG dynamic model.

References

- Azevedo, L. F. A., Braga, A. M. B., Nieckele, A. O., Naccache, M. F. and Gomes, M. G. F. M., 1996, "Simple Hydrodynamic Models for the Prediction of Pig Motions in Pipelines," *Proceedings of the 1996 Offshore Technology Conference*, TX., USA, pp. 729~739.
- Cordell, J. and Vanzant, H. J., 1999, *All About Pigging*, On-Stream Systems Limited and Hershel Vanzant & Associates.
- Fox, J. A., 1977, *Hydraulic Analysis of Unsteady Flow in Pipe Networks* John Wiley & Sons Pub.
- Hodge, B. K. and Koenig, K., 1995, *Compressible Fluid Dynamics with Personal Computer Applications*, Prentice-Hall, Inc., pp. 435~488.
- Kentfield, J. A. C., 1993, *Nonsteady, One-Dimensional, Internal, Compressible Flows: Theory and Applications*, Oxford University Press, pp. 33~118.
- Korea Gas Corporation, March 2000, *The First Stage of Development of Intelligent PIG for Low Pressure Pipeline*.
- Lima, P. C. R., Petrobas, S. A. and Yeoung, H., 1999, "Modeling of Pigging Operations," *Proceedings of SPE Annual Technical Conference and Exhibition*, TX., USA, pp. 563~578.
- Nguyen, T. T., Yoo, H. R., Rho, Y. W. and Kim, S. B., 2001, "Modelling and Simulation for PIG Flow Control in Natural Gas Pipeline," *KSME International Journal*, Vol. 15 No. 8, pp. 1165~1173.
- Out, J. M. M., 1993, "On the Dynamics of Pig-Slug Transients in Gas Pipeline," *OMAE, Vol. V, Pipeline Technology*, ASME, pp. 395~403.
- Price, G. R., McBrien, R. K., Rizopoulos, S. N. and Golshan, H., May 1999, "Evaluating the Effective Friction Factor and Overall Heat Transfer Coefficient During Unsteady Pipeline Operation," *Journal of Offshore Mechanics and Arctic Engineering*, ASME, Vol. 121, pp. 131~136.
- Sim, W. G. and Park, J. H., 1997, "Transient Analysis for Compressible Fluid Flow in Transmission Line by the Method Of Characteristics,"

KSME International Journal, Vol. 11. No. 2, pp. 173~185.

Tannehill, J. C., Anderson, D. A. and Pletcher, R. H., 1997, *Computational Fluid Mechanics and Heat Transfer*, Taylor & Francis Pub.

Tiratsoo, J. N. H., 1992, *Pipeline Pigging Technology*, 2nd ed., Gulf Pub.

White, F. M., 1999, *Fluid Mechanics*, McGraw-Hill Pub.

Wylie, E. B., Streeter, V. L. and Suo, L., 1993, *Fluid Transients in Systems*, Prentice-Hall, Inc.

Zwillinger, D., 1996, *Standard Mathematical Tables and Formulae*, CRC Press, pp. 716-717.