

# An Experimental Study of Supersonic Dual Coaxial Free Jet

**Seung-Cheol Baek, Soon-Bum Kwon\***

*Department of Mechanical Engineering, Kyungpook National University,  
1370 Sankyuk-dong, Daegu 702-701, Korea*

**Byeong-Eun Lee**

*Department of Aeronautical Engineering, Kyungpook National University,  
438 Egeum-dong, Sachon City, Kyungnam 664-180, Korea*

A supersonic dual coaxial jet has been employed popularly for various industrial purposes, such as gasdynamic laser, supersonic ejector, noise control and enhancement of mixing. Detailed characteristics of supersonic dual coaxial jets issuing from an inner supersonic nozzle and outer sonic nozzles with various ejection angles are experimentally investigated. Three important parameters, such as pressure ratios of the inner and outer nozzles, and outer nozzle ejection angle, are chosen for a better understanding of jet structures in the present study. The results obtained from the present experimental study show that the Mach disk diameter becomes smaller, and the Mach disk moves toward the nozzle exit, and the length of the first shock cell decreases with the pressure ratio of the outer nozzle. It was also found that the highly underexpanded outer jet produces a new oblique shock wave, which makes jet structure much more complicated. On the other hand the outer jet ejection angle affects the structure of the inner jet structure less than the pressure ratio of the outer nozzle, relatively.

**Key Words :** Dual Coaxial Jet, Ejection Angle, Mach Disk, Nozzle Pressure Ratio, Pitot Impact Pressure, Supersonic Flow

## Nomenclature

d : Inner nozzle diameter [mm]  
D : Outer nozzle diameter [mm]  
l : Length of nozzle divergent part [mm]  
M : Mach number [-]  
p : Pressure [kPa]  
r : Distance in radial direction [mm]  
Re : Reynolds number [-]  
x : Distance from nozzle exit along jet centerline [mm]

## Sub/superscripts

0 : Stagnation state  
e : Exit state  
b : Back pressure  
m : Mach disk  
t : Throat  
d : Design condition  
i : Inner nozzle or pitot impact pressure  
o : Outer nozzle  
s : Static pressure

## Greek symbols

$\beta$  : Ejection angle of outer nozzle [degree]

## 1. Introduction

A supersonic dual coaxial jet has been employed popularly for various industrial purposes, such as gasdynamic laser, supersonic ejector, noise control and enhancement of mixing. It consists of an inner nozzle (supersonic or sonic nozzle) and an outer (sonic nozzle) one aligned concentrically. One of the representative applica-

\* Corresponding Author,

E-mail : sbkwon@knu.ac.kr

TEL : +82-53-950-5578; FAX : +82-53-950-6550

Department of Mechanical Engineering, Kyungpook National University, 1370 Sankyuk-dong, Daegu 702-701, Korea. (Manuscript Received April 30, 2003;

Revised September 3, 2003)

tions of the supersonic dual coaxial jet is a gas cutting (Crowe, 1942).

Many workers (Masuda and Nakamura, 1993; Masuda and Moriyama, 1994) have studied about the supersonic dual coaxial jets applied to the gas jet cutting technology, and found that the cutting speed and quality can be greatly enhanced by employing an assistant jet. This is because the cutting speed and the quality of cut surface are closely related to the aerodynamic characteristics of the jet. Generally, the cutting speed is proportional to the local impact pressure of the jet impinging on material. In addition, a uniform pressure distribution along the jet centerline is more desirable to obtain a better cutting quality. However, the increase in upstream stagnation pressure to attain high impact pressure may induce harmful effects, such as generation of Mach disk and oblique shock waves, and severe pressure oscillation along jet centerline. However, it has been reported that the generation of the Mach disk was suppressed by imposing an outer jet, removing the difficulties previously mentioned (Masuda and Nakamura, 1993; Masuda and Moriyama, 1994).

The detailed structure for a supersonic single jet has been studied by many authors (Addy, 1981; Chang and Chow, 1974; Crist et al., 1965; Davidor and Penner, 1971). It is well known that Mach disk often appears in underexpanded single jets, if a nozzle pressure ratio becomes over a certain critical value as a result of coalescence of reflected compression waves (Chang and Chow, 1974). In addition, the behaviors of Mach disk are strongly dependent on the nozzle pressure ratio, the specific heat ratio of the gas and nozzle geometry. It is reported that the Mach disk diameter and location are related to empirical relationship. They increase with pressure ratio, but decrease as the specific heat ratio increases (Sherman, 1966; Werle et al., 1970; Kim and Lee, 1996).

Recently, computational and experimental investigations on dual coaxial jets have been done by many workers. Narayanan et al. (1992) investigated the relation between the location of Mach disk and stagnation pressure of the inner

and outer jets. However, they did not study the change of jet structure for the variation of outer nozzle ejection angle, since their investigation was focused on the process of mixing of coaxial jet streams. Masuda et al. (1994) showed that the jet structure and its wave system are closely related to the nozzle geometry and the pressure ratios of inner and outer nozzles by both experimental and computational studies. However, they tested only a dual coaxial nozzle fabricated with both sonic inner and outer nozzles.

In the present study, the detailed characteristics of supersonic dual coaxial jet, such as pitot impact pressure and static pressure distributions, shock waves and behavior of Mach disk, have been investigated experimentally using various combinations of pressure ratios in the inner and outer nozzles and outer nozzle ejection angles. An inner nozzle, which has the design Mach number,  $M_d$  of 1.9, and four outer nozzles with different ejection angles are fabricated for the experimental investigation of jet structures. The major concern about flow conditions at the exit of the inner nozzle is for both correct- and under-expanded conditions.

## 2. Experimental Facility and Procedures

### 2.1 Experimental facility

The experimental facility used in the present study is shown in Fig. 1. It mainly consists of high-pressure chamber, nozzle assembly, Schlieren optical, and pressure measurement systems. The high-pressure tank contains pressurized air is connected to the plenum chamber through a duct.

Air stream is released from the coaxial dual nozzle connected to the plenum chamber. The jet flow is discharged into ambient air. The pressure holes are provided to measure the stagnation pressures in the nozzles. The stagnation pressures in the nozzles are regulated separately by control valves, and are kept constant. In order to remove the effect of air humidity in pressurized air, a moist trap is installed at the inlet of the high-pressure tank.

The detailed schematic of the experimental

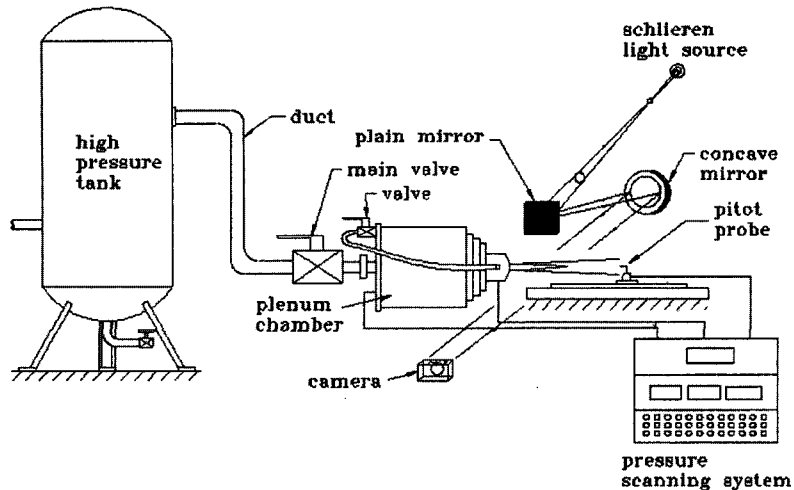

Fig. 1 Schematic of experimental apparatus.

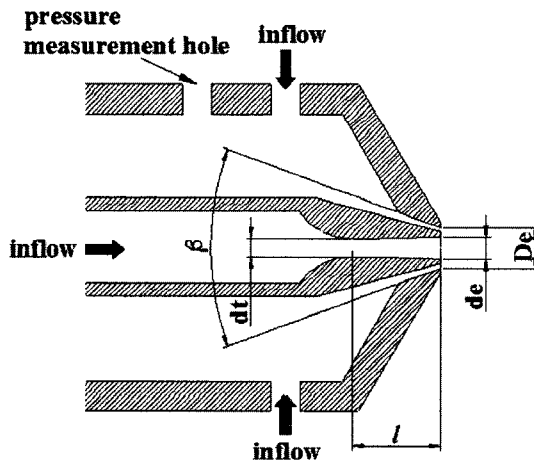

Fig. 2 Schematic of experimental coaxial nozzle.

coaxial nozzle used in the present study is represented in Fig. 2. It consists of an inner supersonic and an outer sonic nozzle having different ejection angles. The inner nozzle is a contoured supersonic one with the throat and exit diameters of  $d_t=4$  mm and  $d_e=5$  mm, respectively.

The length of divergence part of the nozzle ( $l$ ) is 20 mm, and the thickness of the nozzle lip is 1 mm. All outer nozzles are simple convergent ones having the same exit diameter of  $D_e=9$  mm, thus the outer jet is issued through constant gap of 1 mm, embracing the inner jet. The outer nozzle ejection angle,  $\beta$  is varied in the range of  $40\sim 80^\circ$ .

According to the one-dimensional gasdynamic theory without an outer stream, the design Mach number and the pressure ratio corresponding to correct-expanded flow at the inner nozzle exit are  $M_d=1.91$ ,  $p_{01}/p_b=6.8$ , respectively. The Reynolds number based on the upstream plenum conditions and the nozzle exit diameter is calculated to be about  $Re_{d_e}=4.5\times 10^5$ .

## 2.2 Experimental procedures

The pressure ratios of stagnation to the atmospheric pressure in the inner and outer nozzles are designated as PRI and PRO, respectively. In the present study, the PRI and PRO are varied in the range of  $4.6\sim 8.2$  and  $2.0\sim 6.0$ , respectively. The temperature of air in the high-pressure tank is nearly constant at 300 K.

A stainless steel tube having an outer diameter of 0.9 mm is used to measure the pitot impact pressure in jet flow fields. The probe is mounted on an auto-traverse system, and detects pitot impact pressures with 1 mm interval in radial and axial direction of jet up to  $r/d_e=2.0$ ,  $x/d_e=20.0$ , respectively. The static pressure along the jet centerline is also measured by using the static probe having an outer diameter of 1 mm. The pressure sensed by the pressure transmitter (PTX-1400, Druck Co.) is A/D converted, and then recorded by the personal computer. Both the auto-

traverse and pressure scanning systems are controlled by personal computer.

The flow visualization was accomplished by shadowgraph method, as shown in Fig. 1. The optical system consists of light source, a set of plane, concave mirrors, and camera. The illumination is provided by continuous light source with Xenon arc lamp of 1 kW capacity.

### 3. Results and Discussion

Figure 3 shows the shadowgraphs of dual coaxial jet for various PRI, and a constant PRO of 4.0, and the outer nozzle ejection angle of  $\beta=40^\circ$ . It can be found from the figure that both barrel shock and Mach disk appear near the jet centerline. From the previous study, it is known that Mach disk in a single free jet is not formed at the nozzle pressure ratio of the correct-expanded flow condition (Driftmyer, 1972). This result is so interesting phenomenon can't be found in a single jet flow.

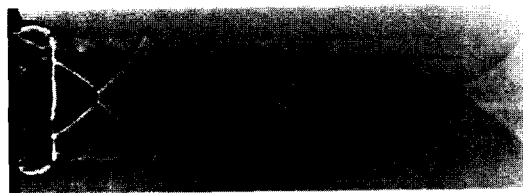

(a) PRI=6.8

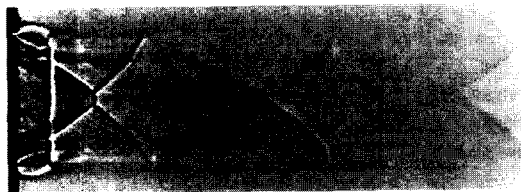

(b) PRI=7.5

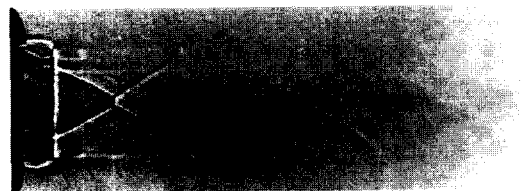

(c) PRI=8.2

Fig. 3 Shadowgraphs of coaxial jet (PRO=4.0,  $\beta=40^\circ$ )

It seems that the outer jet confines the expansion of the inner jet, and the Mach disk is generated in the inner jet. The flow behind the Mach disk is subsonic, whereas the flow behind the reflected shock wave is still supersonic. Therefore, the development of the slip streams can be seen clearly. Due to the highly under-expanded outer jet, a kind of normal shock wave, so-called the annular shock surrounding the inner jet, is generated. The Mach disk diameter at the centerline of the inner jet decreases as the pressure ratio in the inner nozzle increases. For these reasons, the behaviors of Mach disk produced in dual coaxial jet are more complicated than those of single jet. On the other hand, the location of Mach disk moves downstream as the PRI increases.

Figure 4 gives pitot impact pressure distributions for a constant PRO of 4.0, and PRI in the range of 6.8~8.2. It can be seen from Fig. 4(a) that the pressure oscillation along the jet centerline even for nearly correct-expanded condition. The pitot impact pressure rapidly decreases due to the acceleration of jet flow through the expansion waves, and has a local maximum value at around  $x/d_e=1.5$ , corresponding to nearly the position of Mach disk, and it oscillates. This results mean that the flow is in actual somewhat under-expanded at the inner nozzle exit. The pressure oscillation along the jet centerline results from a series of expansion fan, shock waves, and Mach disk. The pressure oscillations are also found in Fig. 4(b) and (c) for under-expanded pressure conditions. However, the overall pitot impact pressure level seems to increase with pressure ratio in the inner nozzle. It was found from the comparison of Figs. 3 and 4 that the position where the pitot impact pressure has a local maximum coincides with the Mach disk location.

Figure 5 shows the effect of the outer jet on jet structure for a constant PRI of 7.5 and outer nozzle ejection angle of  $40^\circ$ . A single jet (Fig. 5 (a)) without an outer jet is issuing from the inner nozzle, making neither a notable shock wave nor a Mach disk. This can be expected from the fact that the single supersonic jet at nozzle exit is just

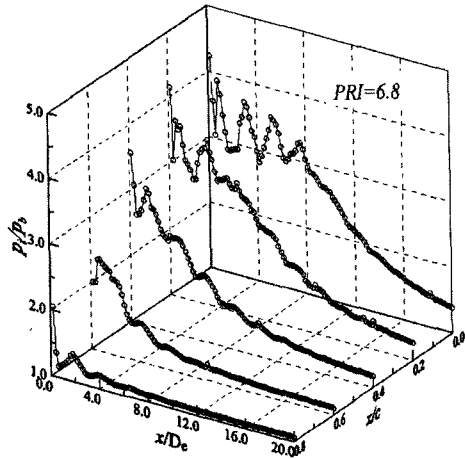

(a) PRI=6.8

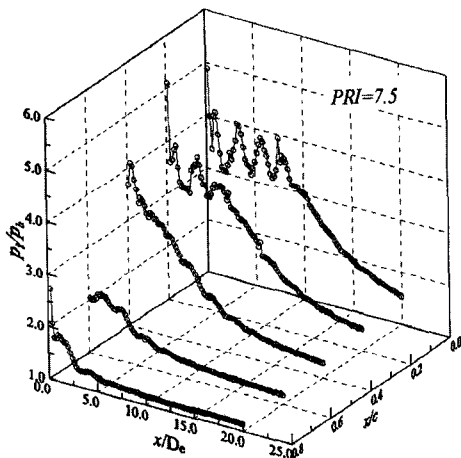

(b) PRI=7.5

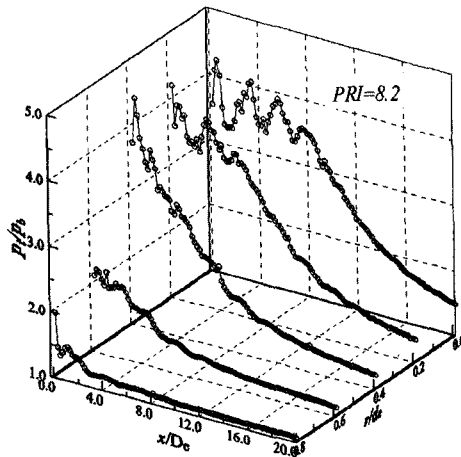

(c) PRI=8.2

Fig. 4 Pitot impact pressure distributions of coaxial jet (PRO=4.0,  $\beta=40^\circ$ )

slightly under-expanded in the present study. The single jet decays rapidly downstream due to viscous effect and momentum exchange with ambient air. For PRO=2.0, a series of Mach waves surrounding the inner jet are generated as the outer jet becomes a nearly correct-expanded condition. It is interesting to note that the Mach disk appears in the inner jet, which does not appear in the single jet (see Fig. 5(a)). The Mach disk can also be seen in the Figs. 5(c) and (d). This comes from the fact that the outer jet suppresses strongly the expansion of the inner jet near the first shock cell. The Mach disk diameter increases with the pressure ratio in the outer jet due to its higher compression effect. In addition,

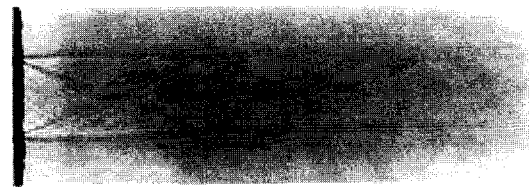

(a) Single jet

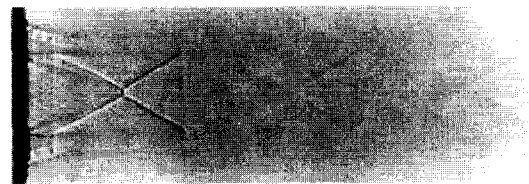

(b) PRO=2.0



(c) PRO=4.0

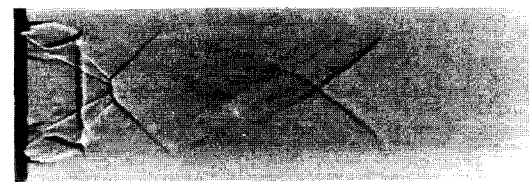

(d) PRO=6.0

Fig. 5 Shadowgraphs of coaxial jet (PRI=7.5,  $\beta=40^\circ$ )

the location of Mach disk moves upstream as the PRO increases. On the other hand, the length of the first shock cell becomes shorter with the PRO. However, it is found in Fig. 5(d) that a new oblique shock is produced behind the first oblique shock wave, which is believed to be the result of the interaction between the annular shock and jet boundary of the inner nozzle.

Pitot impact pressure distributions for a constant PRI of 7.5 and the outer nozzle ejection angle of  $40^\circ$  are shown in Fig. 6. For PRO=2.0, as the flow accelerates through expansion waves from the nozzle exit, pitot impact pressure along a jet centerline is decreased, then increased rapidly due to the incident shock wave. Relatively uniform pitot impact pressure distribution can be seen in the Fig. 6(a). From the Fig. 6(b), for a PRO of 4.0, the pressure oscillates again due to the expansion and oblique shock waves and Mach disk. Furthermore, for a higher PRO of 6.0 given in Fig. 6(c), the pressure distribution becomes so complicated. This is believed due to the generation of multiple shock waves and Mach disk.

Figure 7 shows the static pressure distribution along the jet centerline for a constant PRI of 7.5 and the outer nozzle ejection angle of  $40^\circ$ . It can be seen that the static pressure for single jet oscillates due to the repetition of expansion and compression. It decreases at about  $x/d_e=1.0$ , where the oblique shock wave is formed. For a PRO of 2.0, the pressure oscillation becomes weak, but the oscillation seems to be severer as the pressure ratio of the inner jet increases. It can also be found that the amplitude of pressure oscillation becomes higher with PRO. It should be noted that the static pressure has a peak near the nozzle exit. It indicates that the inner jet could not be fully expanded, because the outer jet strongly suppresses the expansion of inner jet for a higher pressure ratio of the outer nozzle.

Figure 8 shows shadowgraphs of dual coaxial jet for a constant PRI of 7.5 and a PRO of 4.0, where the outer nozzle ejection angle is varied between  $40^\circ$  and  $70^\circ$ . It can be found from the figures that the location of annular shock is not changed with the ejection angle. In addition, the length of the first shock cell becomes somewhat

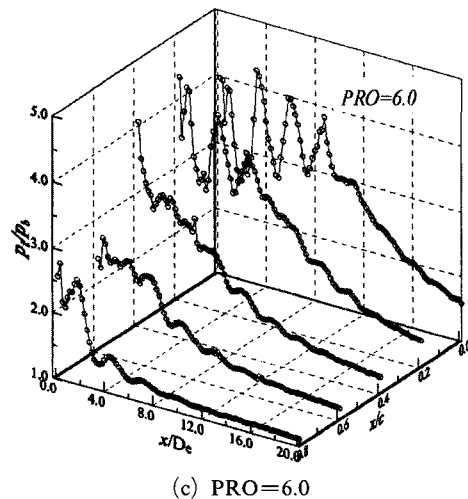
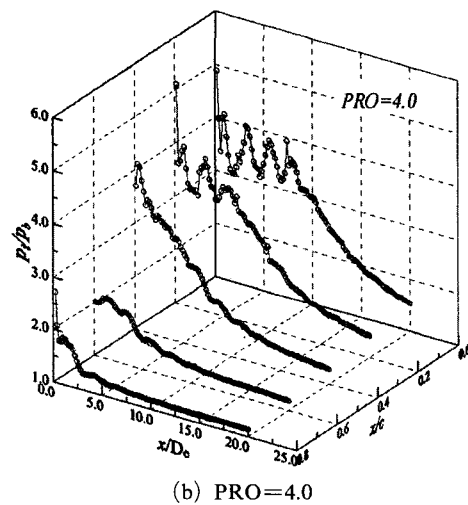
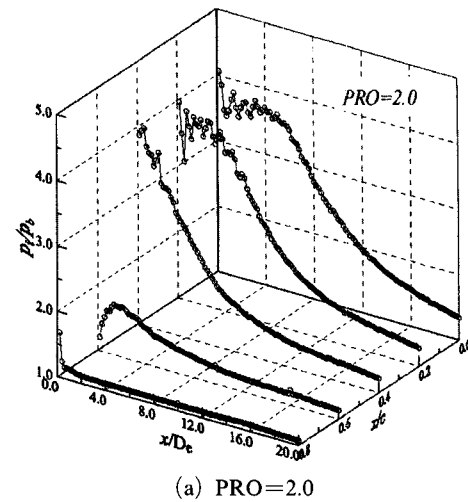

Fig. 6 Pitot impact pressure distributions of coaxial jet (PRI=7.5,  $\beta=40^\circ$ )

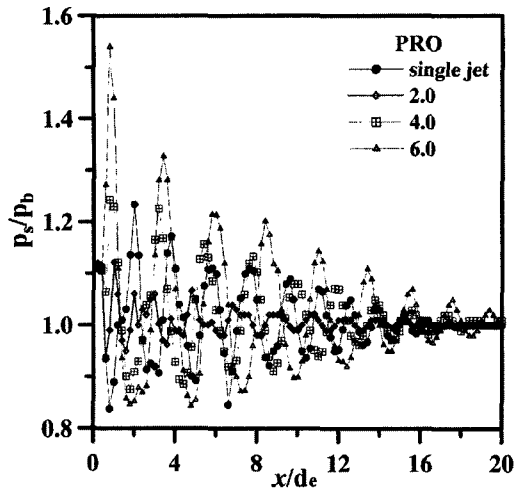

Fig. 7 Static pressure distribution along the jet centerline (PRI=7.5,  $\beta=40^\circ$ )

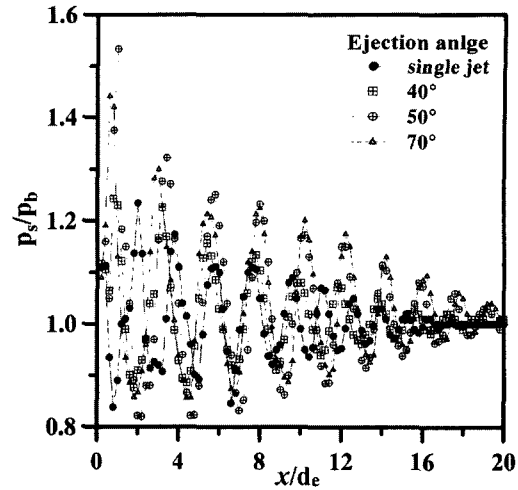
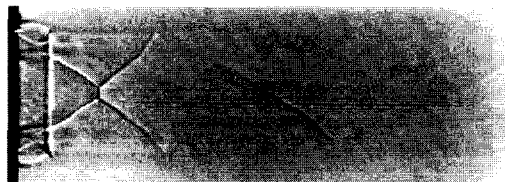
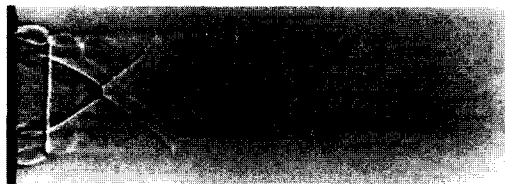

Fig. 9 Static pressure distribution along the jet centerline (PRI=7.5, PRO=4.0)



(a)  $\beta=40^\circ$



(b)  $\beta=50^\circ$

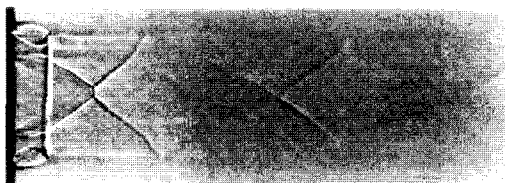

(c)  $\beta=60^\circ$

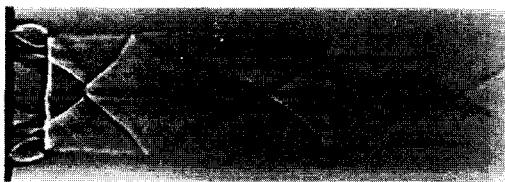

(d)  $\beta=70^\circ$

Fig. 8 Shadowgraphs of coaxial jet (PRI=7.5, PRO=4.0)

shorter with the ejection angle. The Mach disk location is calculated about  $x/d_e=1.7$  using the Driftmyer's empirical relationship (Driftmyer, 1972) for an under-expanded single jet. However, irrespective of the ejection angle, the location is found to be about  $x/d_e=1.2$  in the present study. This demonstrates that the variation of the outer nozzle ejection angle does not affect the location of Mach disk in the inner jet. It is believed that the movement of Mach disk upstream is caused by the suppression of the expansion of inner jet.

Figure 9 gives static pressure distributions along the jet centerline for various outer nozzle ejection angles. It is found from this figure that the static pressures oscillate severely regardless of the outer nozzle ejection angle. The frequencies of pressure oscillation along the jet centerline nearly are the same, except for the single jet. However, the amplitude becomes larger with the ejection angle. It should be mentioned that a single jet is issued as the state of highly under-expanded, while coaxial jet flows are slightly under-expanded flows due to the compression effect of the outer jet.

Figure 10 represents the effect of the pressure ratio of the outer jet on the location of Mach disk from nozzle exit and the Mach disk diameter. It can be seen from this figure that the Mach disk

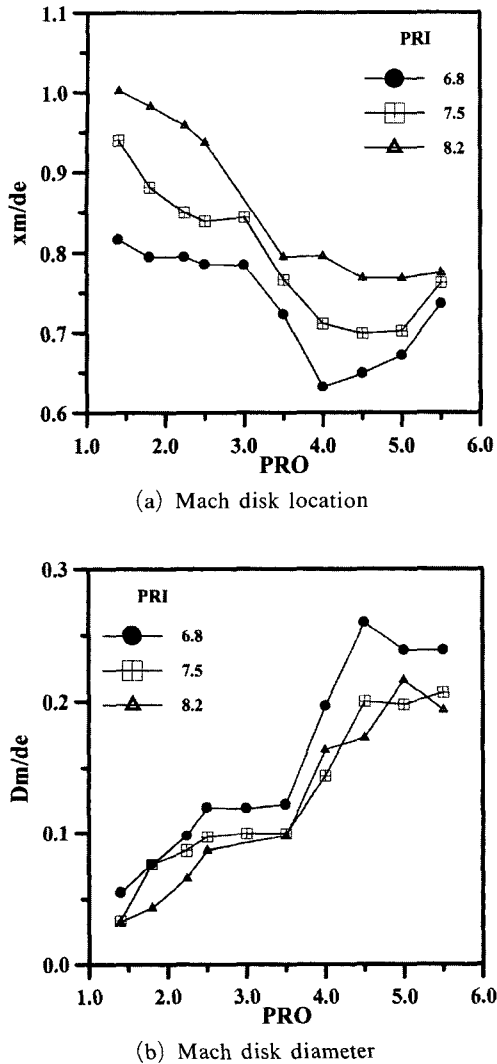

Fig. 10 Mach disk location and diameter vs. outer nozzle pressure ratio

moves toward nozzle exit with the pressure ratio of the outer jet, while the Mach disk diameter increases as the PRO increases. In addition, it can also be seen that the location of Mach disk moves further downstream and the Mach disk diameter becomes smaller as the PRI increases. It is interesting to note that relatively higher pressure ratio, about 5.0 of PRO, the location Mach disk starts to move downstream, while its diameter decreases. These trends of disk location and diameter are believed to be associated with the generation of the new oblique shock wave.

#### 4. Concluding Remarks

An experimental study has been performed to investigate detailed characteristics of supersonic dual coaxial supersonic jet. Three major parameters governing the coaxial jet structures, such as pressure ratios of the inner and outer nozzles, and ejection angle of the outer jet, have been investigated.

It was found from this experimental study that the Mach disk diameter decreases as the pressure ratio of the inner jet increases. On the contrary, the Mach disk location and the length of the first shock cell increase with pressure ratio of the inner jet. Additionally, it is interesting to note that the highly under-expanded outer jet creates another oblique shock wave resulting from the interaction between annular shock produced by the outer jet and boundary of the inner jet. This is the main cause of the complicated pitot impact pressure distribution. However, the outer nozzle ejection angle affects less the jet structure compared to the pressure ratios of each nozzle. In addition, the pressure ratio of the outer nozzle corresponding to the correct-expanded flow condition is more desirable to obtain relatively uniform pitot impact pressure distribution along the jet centerline, which is much more helpful for a better cutting quality.

#### References

- Addy, A. L., 1981, "Effects of Axisymmetric Sonic Nozzle Geometry on Mach Disk Characteristics," *AIAA Journal*, Vol. 19, No. 1, pp. 121~122.
- Chang, I. S. and Chow, W. L., 1974, "Mach Disk from Underexpanded Axisymmetric Nozzle Flow," *AIAA Journal*, Vol. 12, No. 8, pp. 1079~1082.
- Crist, S., Sheerman, P. M. and Glass, D. R., 1966, "Study of the Highly Underexpanded Sonic Jet," *AIAA Journal*, Vol. 4, No. 1, pp. 68~71.
- Crowe, J. J., 1942, "Divergent Nozzle Tips for Economical Oxygen Cutting," *Journal of Weld*, Vol. 21, pp. 34~40.



- Davidor, W. and Penner, S. S., 1971, "Shock Standoff Distances and Mach-Disk Diameters in Underexpanded Sonic Jets," *AIAA Journal*, Vol. 9, No. 8, pp. 1651~1653.
- Driftmyer, R. T., 1972, "A Correlation of Freejet Data," *AIAA Journal*, Vol. 10, No. 8, pp. 1093~1095.
- Kim, H. D. and Lee, J. S., 1996, "An Experimental Study on Supersonic Jet Issuing from Gas Atomizing Nozzle (I)," *Journal of KSME*, Vol. 20, No. 2, pp. 697~709.
- Masuda, W. and Nakamura, T., 1993, "Effects of Nozzle Contour on the Aerodynamic Characteristics of Underexpanded Annular Impinging jets," *JSME Int. Journal*, Vol. 36, No. 2, pp. 238~244.
- Masuda, W. and Moriyama, E., 1994, "Aerodynamic Characteristics of Underexpanded Coaxial Impinging Jets," *JSME Intl. Journal*, Vol. 37, No. 4, pp. 769~775.
- Narayanan, A. K. and Damodaran, K. A., 1992, "Mach Disk of Dual Coaxial Axisymmetric Jets," *AIAA Journal*, Vol. 7, pp. 343~345.
- Sherman, F. S., 1966, "The Structure and Utilization of Supersonic Free jets in Low Density Wind Tunnels," *Rarefied Gas Dynamics*, Vol. 2, pp. 84~105.
- Werle, M. J., Shaffer, D. G. and Driftmyer, R. T., 1970, "Freejet Terminal Shocks," *AIAA Journal*, Vol. 8, No. 12. pp. 2295~2297.