

## Wind Pressure Transients in the Tunnel inside a Station Caused by a Passing High Speed Train

**Nahmkeon Hur**

*Department of Mechanical Engineering, Sogang University,  
Sinsoo 1, Mapo, Seoul 121-742, Korea*

**Sa-Ryang Kim\***

*Department of Precision Mechanical Engineering, Kangnung National University,  
Chibyun 123, Gangneung, Gangwon-Do, 210-702, Korea*

**Wook Kim and Sangyeul Lee**

*Department of Mechanical Engineering, Graduate School, Sogang University,  
Sinsoo 1, Mapo, Seoul 121-742, Korea*

When a High Speed Train (HST) passes through a station with no stop, effects of wind pressure transients caused by this passing train have to be considered for the safety of passengers on the platform and for the possible structural safety problems as well. In Gwangmyeong and Daejeon stations of the Korean high speed railroad, tunnels inside stations for the passing train are proposed to reduce the noise and wind pressure transients to the passengers on the platform. In the present study, transient 3-D full Navier-Stokes solutions with moving mesh to implement train movement are obtained and compared with the results obtained by the towing tank experiment. Investigations on flow phenomena for various train speeds and design modifications are also performed.

**Key Words :** Pressure Transient, High Speed Train, Station, Moving Mesh

### 1. Introduction

Unlike conventional trains, the High Speed Train is operated at a very high speed of around 300 km/h. Due to this high speed, careful investigations should be made for the safety concerns. Among these are the problems associated with the train entering the tunnel, trains passing each other, and train passing through the station with no stop. Especially when HST passes through some stations with no stop, the abrupt pressure change and induced wind by the passing

train may cause uneasiness and safety problems to the passengers on the platform. In Japan, France, and Germany, when it is necessary, the HST passes through the stations at a sufficiently reduced speed. However, in Korea, it is being considered that the HST passes through some stations at a considerably higher speed (maybe up to its full speed). For this circumstance, it is proposed to have tunnels inside stations to isolate the passing HST, and hence to reduce the noise and the effects of abrupt pressure changes and induced wind. Tunnels inside stations may also cause problems associated with pressure waves generated when the HST enters the tunnel.

Most studies concerning the unsteady aerodynamics of HST are mainly numerical ones due to the difficulties in the experiments. Numerical simulations are not also easy since one has to resolve the moving train inside geometrically complicated stations. Until now it is very difficult

---

\* Corresponding Author,

**E-mail :** dearksr@kangnung.ac.kr

**TEL :** +82-33-640-2395; **FAX :** +82-33-640-2244

Department of Precision Mechanical Engineering,  
Kangnung National University Chibyun 123, Gangneung, Gangwon-Do, 210-702, Korea. (Manuscript

**Received** June 18, 2001; **Revised** June 15, 2004)

and time consuming process to get 3-D full Navier-Stokes solutions with moving mesh in general body-fitted coordinate system.

Numerical simulations on French TGV are performed by GEC Alstom (See Aita et al., 1992; Massbernat et al., 1993; and Mestreau et al., 1993). French TGV entering a tunnel was simulated numerically by Aita et al. (1992), and a possibility of performing a three-dimensional unsteady flow analysis on the actual operation of the High Speed Train was shown. In Japan, Ogawa and Fujii (1994) numerically solved 2-D flow problem of train entering tunnel, and they showed that a micro-pressure wave is emitted out of the tunnel when the compression wave generated at the tunnel entry arrived at the exit of the tunnel. Fujii and Ogawa (1995) later performed a numerical analysis on the unsteady three-dimensional flow derived by the passing two trains. It was shown that the strength of pressures and moments acting on the train due to the passing train depends on their head shapes and relative positions. Mackrodt group of DLR at Goettingen in Germany has produced numerical and experimental results on aerodynamics of German ICE (Mackrodt et al., 1980; Mackrodt and Pfizenmeir, 1987).

In Korea, many experimental and numerical studies on the aerodynamics of the HST and on the tunnel entry problem were carried out for the ongoing construction of Korean High Speed Railway System (Chun, 1994; Chun and Kim, 1996; Kim, 1997a, b; Kim et al., 1995; Hur, 1995; 1997a, b; Hur et al., 1998). Recently, Hwang and Lee (2000) obtained aerodynamic loads on HST passing by each other at a speed of 350 km/h through the tunnel by numerical simulation using 3-D Euler equation. Kwon et al. (2000) performed wind tunnel test for the aerodynamic drag of Korean HST model. Kim and Hur (2001) suggested the mesh transformation method for the movement of the body in the fluid medium instead of conventional moving mesh technique and showed good agreements. Cho et al. (2001) showed the partition wall reduces the pressure load to a passenger on platform by passing HST in Cheonan-asan station.

In the present study, the investigations on pressure transients associated with the passing HST in Gwangmyeong station and Daejeon station are performed. The results of the present study are also applicable to the strength design of the tunnel structures.

## 2. Numerical Simulation

For the simulation of passing HST through stations, a commercial code of STAR-CD V3.0 on SGI Origin 2000 parallel server (4 R10000 CPUs, 512MB RAM, 18GB HDD) is used. STAR-CD is a general purpose computational fluid dynamics (CFD) code capable of handling moving meshes in complex geometry. Transient full 3-D Navier-Stokes solution is obtained with standard  $k-\varepsilon$  turbulence model. At the train speed of 350 km/h, Mach number is about 0.29. Compressible flow is assumed adopting ideal gas law.

A cross-section drawing of Gwangmyeong station is shown in Fig. 1. The HST tracks are just below the ground level which consist of some bridges so that passengers can see the passing tracks in the center of the station and covered with tunnel wall (It is a drawing of the original design. Later, the design of tunnel in Gwangmyeong station is altered into the partition wall. In this study, original tunnel structure is considered). Figure 2 shows the computational meshes for Gwangmyeong station. Solid meshes including station and train are located center of the computational meshes and separately shown below the total meshes for easy comprehension. Total number of computational cells used in Gwangmyeong station is over one million, among

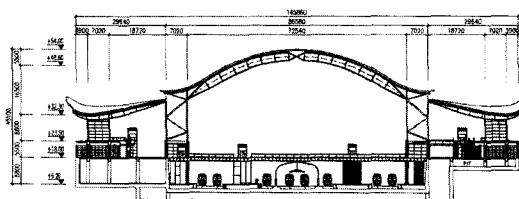

Fig. 1 A cross-section drawing of Gwangmyeong station

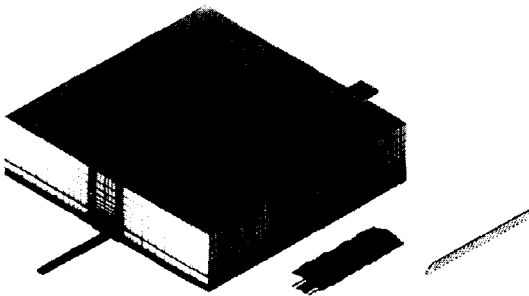

Fig. 2 Meshes for Gwangmyeong station

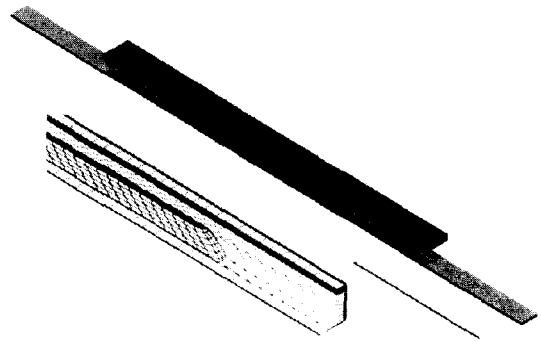

Fig. 4 Meshes for Daejeon station (Underground part)

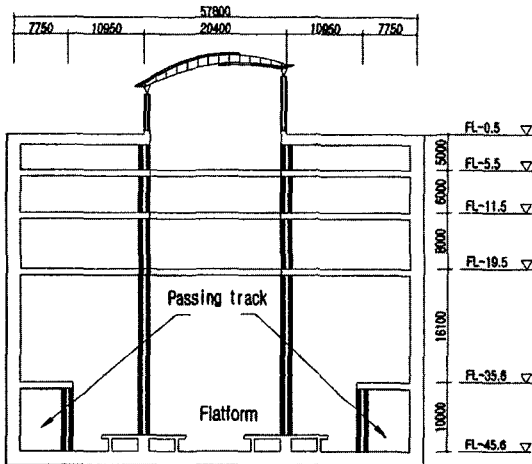

Fig. 3 A cross-section drawing of Daejeon station

which 636,000 cells are located in station area including 122,800 moving meshes to implement the movement of HST. The computational domain is 1600 m long, 1,000 m wide, and 260 m high. The length of HST is 400 m. The passing tunnel in the station has the length of 468 m and cross-sectional area of 107 m<sup>2</sup> with arch shape for double tracks. The computation consists of 460 time steps and requires 60 hours of CPU time for the analysis. Constant atmospheric pressure is given to the outer boundary condition and no-slip condition is applied to the moving or static walls.

In Fig. 3, a cross-section drawing of Daejeon station is shown. (Later, the design of underground station is withdrawn. But in this study, original underground station is considered). In Daejeon station, the HST tracks are located at 41.2 m deep below ground level. And passing

tracks are at both sides of the station so that the passing tunnels have rectangular cross section and area of 43.5 m<sup>2</sup> for a single track. Figure 4 shows the underground part of meshes for Daejeon station. Total number of 627,000 meshes is used in this case, including 122,800 moving meshes. The dimension of computational domain is the same as that in the case of Gwangmyeong station. It also takes 40 hours of CPU time with 460 time steps. The speed of HST is varied from 120 km/h up to 350 km/h in both cases.

Grid refinement test was performed with the grid whose number of meshes inside the station is increased more than twice. But the difference of the values of pressure was not considerable, so that the present grid used in the numerical simulation.

Initially train was stationary. So, all pressure in the calculating domain is atmospheric pressure. From time 0, the train begins to move with constant speed from the location 80 m apart from the platform. Time increment was set to such values that the Courant number became equal to 1. Implicit first order scheme is used for the time integration.

### 3. Results and Discussion

For the validation of the result of numerical simulation, the computations with the incompressible flow assumption are performed for the same conditions with towing tank experiment of 1/50 scale model (Hur, 1997a, b) because con-

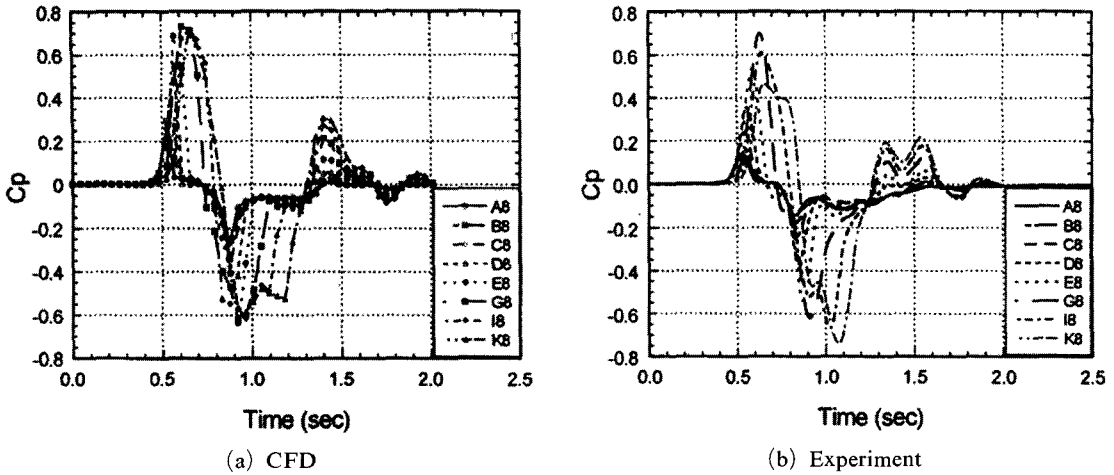

Fig. 5 Comparison of pressure coefficient curves from CFD with experiment

ventional numerical technique can not be applied to the present study. The length of tunnel is 4 m and the speed of HST model is 5.73 m/s. Reynolds number based on the width of HST is  $3.42 \times 10^5$ . In Fig. 5, the variation of pressure coefficients from simulation along the top of the tunnel as the HST passes in Daejeon station was shown compared with that from towing-tank experiment. The computational and the experimental results agree well qualitatively and quantitatively, thus giving the validity of the computational results. This towing tank experiment could not explain the micro pressure propagation effect, and the comparison was confined to the pressures inside the tunnel. In the figure symbols A8 to K8 represent the measuring locations along the tunnel from the tunnel entrance. A to K means the position where pressure is measured and each matches the distance of  $1/4w$ ,  $1/2w$ ,  $1w$ ,  $2w$ ,  $3w$ ,  $4w$ ,  $5w$ ,  $6w$ ,  $7w$ ,  $8w$ ,  $9w$  from entrance of the tunnel, where  $w$  is the width of tunnel model. The number following alphabet means the position in tunnel circumferential direction and 8 matches top position of tunnel at center plane. For the case of Gwangmyeong station, the similar results are obtained and not shown here.

The absolute maximum pressure and pressure coefficients are shown in Fig. 6 for some train speeds considered. The pressure has a parabolic profile and the result is consistent with the idea that maximum pressure is related with dynamic

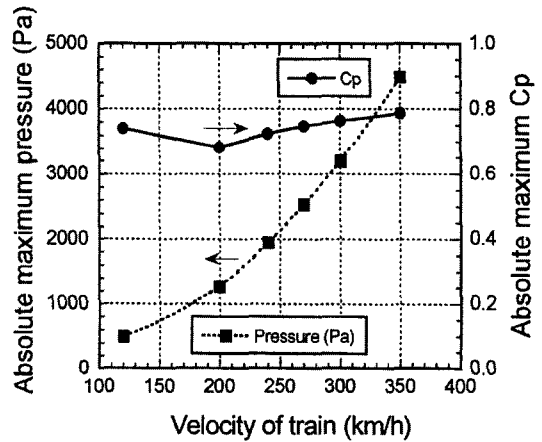

Fig. 6 Variation of absolute maximum pressure and pressure coefficient for the train speed

pressure of the speed of train, and dynamic pressure is proportional to the square of the speed. The absolute maximum pressure coefficients varies  $\pm 5\%$  within the considered range of train speed. But as the speed increases, variation of the pressure coefficient is decreased, and the pressure coefficient seems to be converged to some value. It may be due to either the boundary layer effect or viscos damping effect. As the Reynolds number increases, the thickness of boundary layer decreases and the effect of boundary layer decreases. Therefore the compression wave gets less disturbance from the boundary layer and strength of the compression wave may increase more or less. Thus, the flow asymptotically becomes poten-

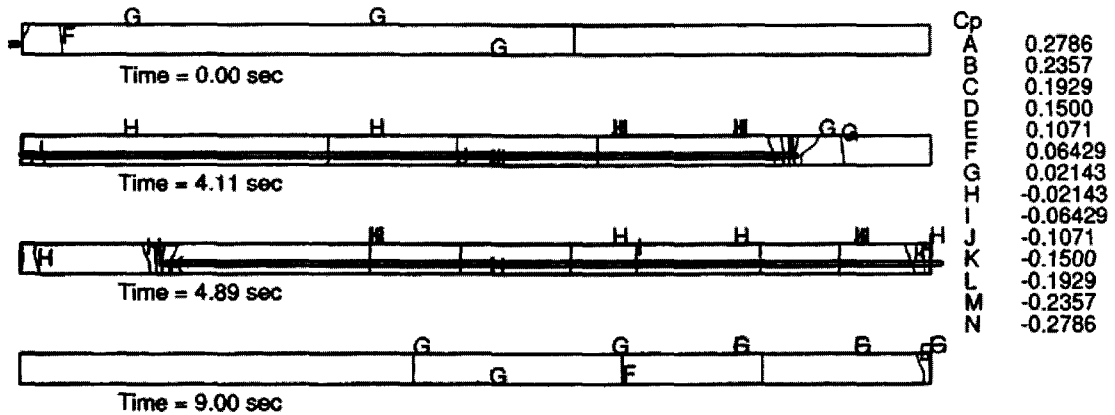

Fig. 7 Pressure distributions in the tunnel as HST passes through Gwangmyeong station

tial flow and the pressure coefficient will become constant. Kim et al. (1995) and Hur (1995) shows the similar tendency in their study for the Cheonan-asan station. Therefore, the results shown and discussed in this paper is for the case that the train speed is 350 km/h, showing the highest value of pressure coefficient.

Figure 7 shows the contours of pressure coefficient in the tunnel as HST passes through the Gwangmyeong station. The head of HST is about to enter the tunnel at time 0. After 4.11 sec, the tail of HST enters the tunnel. It can be seen from the figure that the compression waves occur when the head of HST enters the tunnel. This compression wave is travelling toward the exit of the tunnel and reflected as an expansion wave. This wave traveling phenomena is further complicated as another expansion wave is generated when the tail of the HST enters the tunnel. The pressure coefficient based on the stagnation pressure varies from  $-0.28$  to  $0.28$  during the HST passes through the tunnel. The pressure rise across the compression wave front can be written as follows (Howe et al., 2000):

$$\frac{\rho_o U^2}{1-M^2} \frac{A_o}{A} \left(1 + \frac{A_o}{A}\right)$$

where  $\rho_o$ ,  $U$ ,  $M$ ,  $A_o$  and  $A$  respectively denote the mean air density, train speed, train Mach number and the cross-sectional areas of the train and the tunnel. Using this equation,  $C_p=0.22$  is obtained. The present result (0.28) is 27% higher

than the values from above formula. The main reason of this discrepancy is thought that above formula comes from one-dimensional (and axisymmetric) analysis and gives area-averaged value, but the present result is the local maximum value and the geometry is not axisymmetric. Local maximum occurs near the nose of the train, and averaged pressure at that cross-section may be much lower than the maximum.

Figure 8 shows the time history of pressure fluctuations at locations of tunnel ceiling height as HST passes through Gwangmyeong station. In the figure, tunnel is located between distances 0 to 468 m. As HST enters the tunnel, a compression wave is built up and propagates toward the tunnel exit at a sonic speed (Fig. 8(a)). As shown in Fig. 8(b), the compression wave becomes an expansion wave as it reaches the tunnel exit and propagates back toward the tunnel entrance. During the course of propagation, the wave meets upcoming HST and the wave pattern becomes more complicated (Fig. 8(c)). Once again the expansion wave becomes a compression wave as it arrives at the tunnel entrance and propagates toward the exit at a rather reduced strength (Fig. 8(d)).

The speed of propagating compression wave is the same as sound speed and is faster more than three times the train speed. As the train travels through the tunnel, it meets expansion wave twice and compression wave once caused by the train entering the tunnel. Such wave propagations in

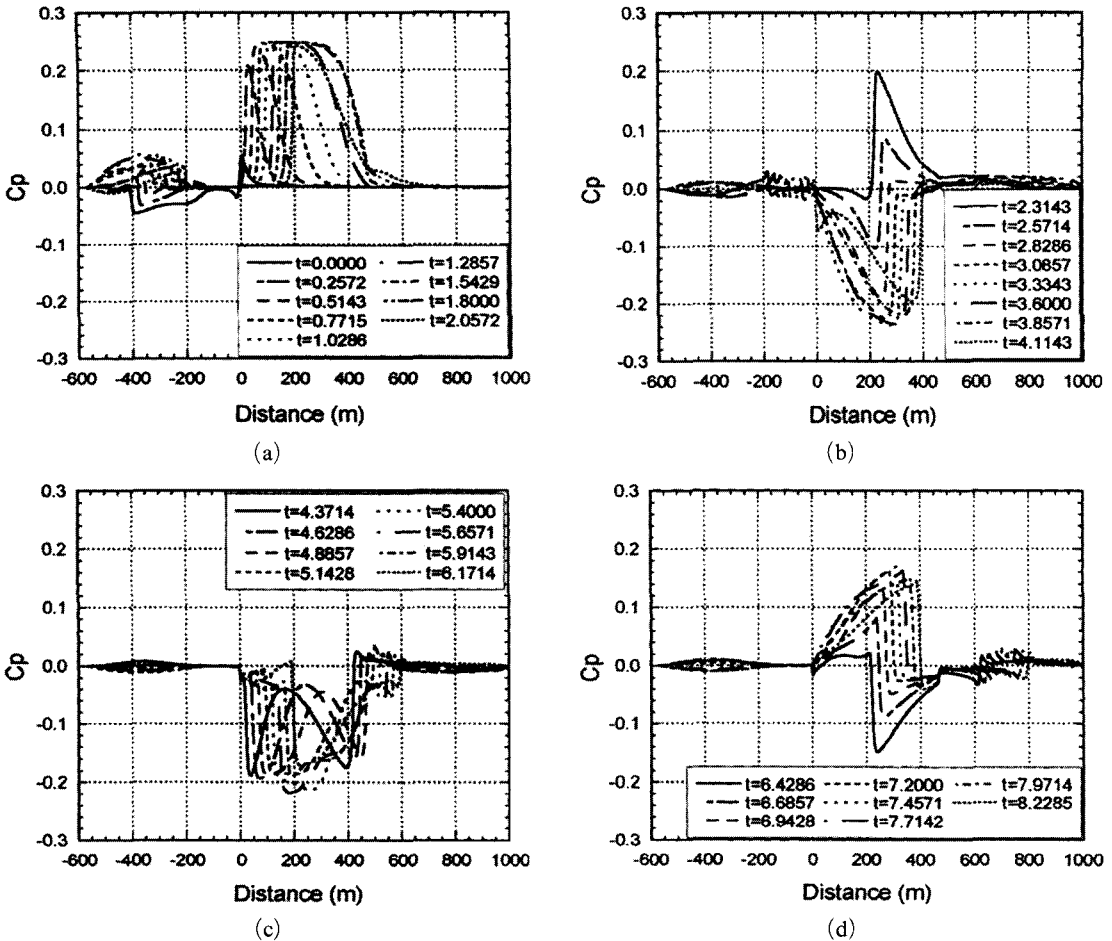

Fig. 8 Pressure transients at locations of tunnel ceiling height as HST passes through Gwangmyeong station

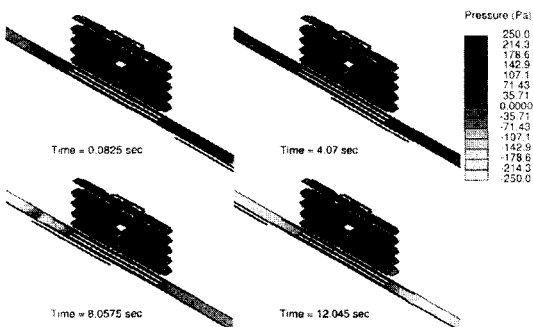

Fig. 9 Pressure distributions at the floors of Daejeon station

tunnel seem to be similar to the usual case with train passing a long tunnel. Also from the computational results the highest pressure gradients are only seen at the ends of the platform. There-

fore the tunnel is found to be effective as a barrier to wind pressure induced by passing HST.

Pressure contours at each floor of Daejeon station are shown in Fig. 9 as the train passes through the station. Train moves right to left. It shows the pressure by passing train does not much affect upper floors. The highest pressure occurs when train enters the passing tunnel, but the magnitude is not so high. The time history of fluctuations at locations of tunnel ceiling height as HST passes through Daejeon station is shown on Fig. 10. Figure 10(a) and 10(b) are for the case when tunnel wall is separating the passing tracks from the platform, where the maximum pressure coefficient becomes 0.8 mainly due to higher blockage ratio compared with that in the case of Gwangmyeong station. Figure 10(c) and

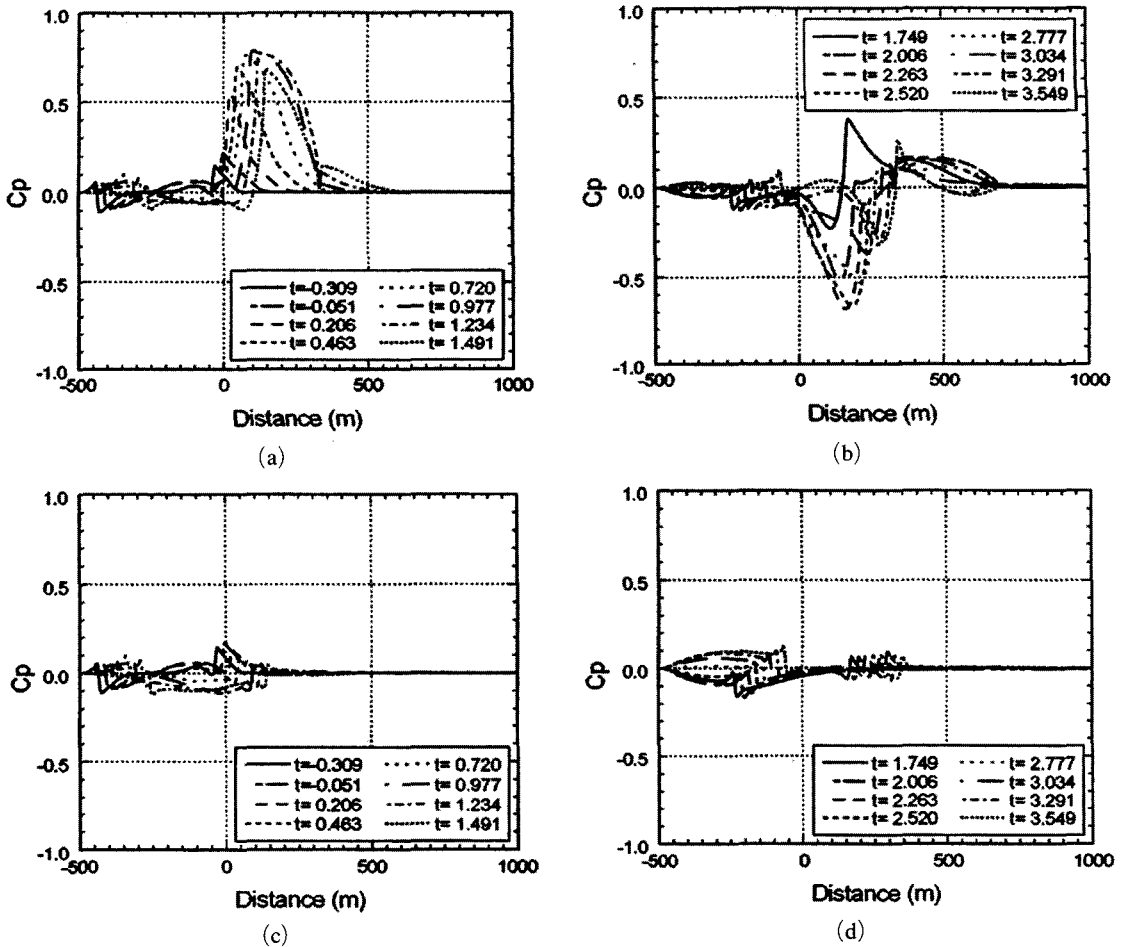

Fig. 10 Pressure transients at locations of tunnel ceiling height as HST passes through Daejeon station : (a), (b) With tunnel ; (c), (d) Without tunnel

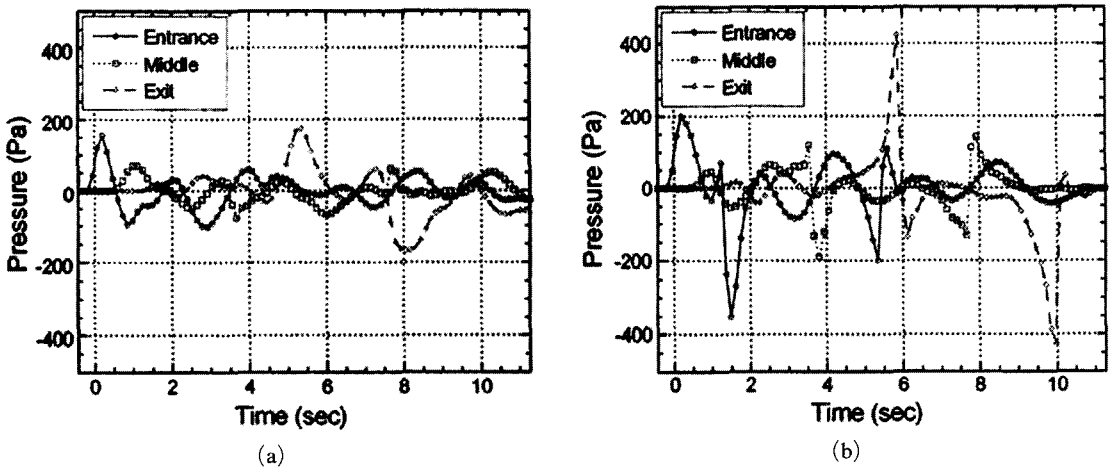

Fig. 11 Pressure transients at three positions on the platform as HST passes through Daejeon station : (a) With tunnel, (b) Without tunnel

10(d) are for the case when tunnel walls are absent. From the figures, it can be observed that wave propagation patterns are similar to that in Gwangmyeong station. And, the existence of the tunnel makes the absolute pressure become so high that both the safety and the comfortableness should be concerned during the design and construction. Figure 11 shows the pressure variations at three positions on the platform with or without tunnel. Entrance means the position near the tunnel entrance during the high speed train passes. Middle denote the mid-point of the platform in longitudinal direction. Exit is the opposite position to the Entrance. It can be seen the pressure peaks near the head and tail of the train are much reduced by the existence of the tunnel. Thus tunnel reduces the pressure gradient due to the passing train. Though the micro pressure propagation effect may occur through the exit of the tunnel, it is thought that it has much less effect than the direct effect of the pressure rise on the passenger and the building structures due to the passing train. Thus, It is noted from the figures that the existence of tunnel reduces the wind pressure transients. However, since the pressure waves inside the tunnel may give problems to the passengers onboard HST, it is recommended to consider both aspects carefully.

#### 4. Concluding Remarks

A numerical simulation was performed to study on the effects of the wind pressure transients caused by the passing HST in stations. The followings are concluded from the present study :

(1) The pressure coefficients obtained by numerical simulation agree well with the results of towing tank experiment.

(2) When the train passes through the tunnel in Gwangmyeong station with the speed of 350 km/h, the maximum pressure coefficient on the tunnel wall is 0.28. In the case of Daejeon station, the maximum value is 0.8, whose difference is mainly due to the differences in the blockage ratio. These values are found to be insensitive to the HST speeds.

(3) The tunnel in the station is found to be effective for the safety of passengers on the platform. However, since the pressure waves inside the tunnel may give problems to the passengers onboard HST, it is recommended to consider both aspects carefully.

#### Acknowledgment

The authors would like to acknowledge the financial support of this study by the Korea High Speed Railway Construction Authority.

#### References

- Aita, S., Tabbal, A., Mestreau, E., Montmayeur, N., Masbernat, F., Wolfhugel, Y. F. and Dumas, J. C., 1992, "CFD Aerodynamics of the French High-Speed Train," *SAE 920343*, SAE.
- Cho, D., Hur, N. and Kim, S. -R., 2001, "A Numerical study on Effect of a Partition Wall Height on Wind Pressure Load when KTX passes through a Station," *Journal of Computational fluids Engineering*, KSCFE, Vol. 6, No. 1, pp. 56~62.
- Chun, C. -H., 1994, "Aerodynamic Problems of High Speed Train - A Review and Perspectives," *AFERC Report*, AFR-92-B02, AFERC, POSTECH.
- Chun, C. -H. and Kim, Y. -H., 1996, "Experiments on Pressure Variation Caused by a High Speed Train Entering a Short Tunnel," *AFERC Report*, AFR-95-B02, POSTECH, pp. 113~151.
- Fujii, K. and Ogawa, T., 1995, "Aerodynamics of High Speed Trains Passing by each Other," *Proceedings of 1995 KSCFE Spring Conference*, pp. 5~36.
- Howe, M. S., Iida, M., Fukuda, T. and Maeda, T., 2000, "Theoretical and Experimental Investigation of the Compression Wave Generated by a Train Entering a Tunnel with a Flared Portal," *J. Fluid Mech.*, Vol. 425, pp. 111~132.
- Hur, N., 1995, *A Report on Wind Pressure Distribution caused by a Train in Chonan station*, KIST Report, KHSRCA, pp. 170~171.
- Hur, N., 1997a, *A Report on Wind Pressure Distribution caused by a Train in Nam-Seoul*



station, Report of Industrial Technology Research Center, Sogang univ.

Hur, N., 1997b, *A Report on Wind Pressure Distribution caused by a Train in Daejeon station*, Report of Industrial Technology Research Center, Sogang univ.

Hur, N., Kim, S.-R., Kim, W. and Lee, S., 1998, "Wind Pressure Transients Inside a Station Caused by a Passing High Speed Train," *Proc. of 4th KSME-JSME Fluids Eng. Conf.*, Haeundae, Pusan, Korea, Oct. 18-21, KSME and JSME, pp. 173~176.

Hwang, J. and Lee, D.-H., 2000, "Unsteady Aerodynamic Loads on High Speed Trains Passing by Each Other," *KSME International Journal*, Vol. 14. No. 8. pp. 867~878.

Kim, H.-D., 1997a, "Aerodynamic Analysis of a Train Running in a Tunnel (I) - Aerodynamics of One-Train," *Transaction of the KSME (B)*, Vol. 21, No. 8, pp. 963~972.

Kim, H.-D., 1997b, "Aerodynamic Analysis of a Train Running in a Tunnel (II) - Aerodynamics of Two-Trains," *Transaction of the KSME (B)*, Vol. 21, No. 8, pp. 983~995.

Kim, S.-R., Lee, K. H., Ahn, I. K. and Hur, N., 1995, "A Study on the Wind Pressure Distribution During High Speed Train Passes through Chonan Station," *Proceeding (II) of KSME '95 Autumn Conference*, KSME, pp. 115~119.

Kim, T. G. and Hur, N., 2001, "A Numerical Analysis on Flows Around a Moving Body Using a Mesh Transformation Method," *Transaction of the KSME (B)*, Vol. 25, No. 4, pp. 593~599.

King, W. F. III, Mackrodt, P. A. and Pfizenmeir, E., 1993, "The Aerodynamics and Acoustics of High-Speed Tracked Vehicles," *Proceeding of the International Conference on Speedup Technology for Railway and Maglev Vehicles*, JSME, Yokohama, Japan.

Kwon, H.-B., Lee, D.-H. and Baek, J.-H., 2000, "An Experimental Study of Aerodynamic Drag on High-speed Train," *KSME International Journal*, Vol. 14. No. 11. pp. 1267~1275.

Mackrodt, P. A. and Pfizenmeir, E., 1987, "Aerodynamick und Aeroakustik fur Hochgeschwindigkeitszuge," *Physik in unserer Zeit*, Vol. 18, No. 3, pp. 65~76.

Mackrodt, P. A., Steinheuer, J. and Stoffers, G., 1980, "Aerodynamisch Optimal Kopfformen Fur Triebzuge," *AET*, Vol. 35, DFVLR.

Massbernath, F., Wolffhugel, Y.-F. and Dumas, J.-C., 1993, "CFD Aerodynamics of the French High-Speed Train," *GEC ALSTHOM Technical Review* 11.

Mestreau, E., Loehner, R. and Aita, S., 1993, "TGV Tunnel Entry Simulations Using a Finite Element Code with Automatic Remeshing," *AIAA Paper*.

Ogawa, T. and Fujii, K., 1994, "Numerical Simulation of Compressible Flows Induced by a Train' Moving Into a Tunnel," *Computational Fluid Dynamics Journal*, Vol. 3, No. 1, pp. 63~82.

*STAR-CD Version 3.0 Manuals*, 1996, Computational Dynamics.