

## Analysis of Cutting Properties with Reference to Amount of Coolant used in an Environment-Conscious Turning Process

**Seung-Han Yang\***

*School of Mechanical Engineering, Kyungpook National University,  
1370, Sankyuk-dong, Puk-gu, Daegu 702-701, South Korea*

**Young-Moon Lee**

*School of Mechanical Engineering, Kyungpook National University,  
1370, Sankyuk-dong, Puk-gu, Daegu 702-701, South Korea*

**Young-Suk Kim**

*School of Mechanical Engineering, Kyungpook National University,  
1370, Sankyuk-dong, Puk-gu, Daegu 702-701, South Korea*

In the recent years, environmentally conscious design and manufacturing technologies have attracted considerable attention. The coolants, lubricants, solvents, metallic chips and discarded tools from manufacturing operations will harm our environment and the earth's ecosystem. In the present work, the Tukey method of multiple comparisons is used to select the minimum level of coolant required in a turning process. The amount of coolant is varied in 270 designed experiments and the parameters cutting temperature, surface roughness, and specific cutting energy are carefully evaluated. The effects of coolant mix ratio as well as the amount of coolant on the turning process are studied in the present work. The cutting temperature and surface roughness for different quantity of coolant are investigated by analysis of variance (ANOVA)-test and a multiple comparison method. ANOVA-test results signify that the average tool temperature and surface roughness depend on the amount of coolant. Based on Tukey's Honestly Significant Difference (HSD) method, one of the multiple comparison methods, the minimum level of coolant is 1.0 L/min with 2% mix ratio in the aspect of controlling tool temperature. F-test concludes that the amount of coolant used does not have any significant effect on specific cutting energy. Finally, Tukey method ascertains that 0.5 L/min with 6% mix ratio is the minimum level of coolant required in turning process without any serious degradation of the surface finish. Considering all aspects of cutting, the minimum coolant required is 1.0 L/min with 6% mix ratio. It is merely half the coolant currently used i.e. 2.0 L/min with 10% mix ratio. Minimal use of coolant not only economically desirable for reducing manufacturing cost but also it imparts fewer hazards to human health. Also, sparing use of coolant will eventually transform the turning process into a more environment-conscious manufacturing process.

**Key Words :** Cutting Temperature, Surface Roughness, Analysis of Variance (ANOVA), Tukey Method of Multiple Comparisons, Honestly Significant Difference (HSD)

---

\* Corresponding Author,

E-mail : syang@knu.ac.kr

TEL : +82-53-950-6569; FAX : +82-53-950-6550

School of Mechanical Engineering, Kyungpook National University, 1370, Sankyuk-dong, Puk-gu, Daegu 702-701, South Korea. (Manuscript Received May 18, 2004; Revised September 27, 2004)

---

### Nomenclature

$\alpha$  : The probability of error (Type I)

$d$  : Depth of cut (mm)

$f$  : Feed (mm/rev)

$F_0$  : Test statistic for F test

$F_y$  : Principal cutting force (N)

$H_0$  : Null hypothesis  
 $n$  : Number of samples  
 $S$  : Standard deviation  
 $t$  : Number of independent observations  
 $\Delta T$  : Change in temperature  
 $T_0$  : The temperature at the beginning of cutting  
 $T_n$  : The temperature after  $n$  seconds  
 $u$  : Specific cutting energy ( $\text{N}/\text{mm}^2$ )  
 $V$  : Cutting velocity ( $\text{m}/\text{min}$ )  
 $\nu$  : Number of degrees of freedom

## 1. Introduction

The demand for green products has been greatly increased due to the impact of environmentally conscious design and manufacturing technologies. A wide range of environmental laws and regulations have been promulgated to protect the environment from further degradation as a result of industrialization. Coolants, lubricants, solvents, metallic chips and discarded tools from manufacturing operations will harm our environment and the earth's ecosystem. Coolant is the most damaging pollutant in machining (Byrne and Scholta, 1993). Excessive use of coolant is also undesirable considering economic aspect. According to a research report in Germany, purchasing and maintenance costs of coolants occupy 7.5% and 17% of total manufacturing cost respectively, where as cost of tooling is merely 4% (Byrne and Scholta, 1993). In addition, the by-products of coolant are difficult to treat or dispose. Coolant cannot be recycled conveniently due to decomposition, chemical reaction with tool powder/metal powder generated in machining and due to mixing with lubricant. Usually coolant is discarded after use and thus pollutes the ecosystem. The most troublesome problem is that coolant is hazardous to human health, as it is sprayed in air and directly inhaled by an operator as well. European countries strive to reduce the amount of coolant used in manufacturing operations by implementing strict laws (Byrne and Scholta, 1993).

The problems associated with coolant can be avoided to some extent by dry cutting without any coolant and cutting with air instead of coolant

have been considered recently (Aronson, 1994; Byrne and Scholta, 1993). It is a well known fact that coolant eliminates heat generated in machining and lowers the temperature of tool and work piece. As a result, residual stress of the machined work piece is decreases and the dimensional accuracy is improved. However, it is difficult to use dry cutting technologies for materials with poor machinability. Also, cutting with air requires a large capital investment due to the necessity of new equipment installation. In order to overcome these difficulties it is recommended to use the coolant sparingly by studying the effects of coolant on the materials being machined and the environment. The variation of temperature and depending on the amount of coolant has been analyzed using multiple comparison method (Yang et al., 2003).

In this research work, a method of multiple comparisons is employed to identify a method to reduce the amount of coolant in machining. Three major machining characteristics have been considered in the present work : cutting force applied to a machine, surface finish determining the grade of a machined work piece, and cutting temperature affecting dimensional accuracy and tool life. Without the necessity of installing new equipment, the coolant amount is changed to evaluate its effect on cutting energy, surface finish and cutting temperature. While carrying out investigations to ensure better results using less amount of coolant both environmental aspects and economic aspects associated with coolants are considered. Finally, to establish the effectiveness of the methodology, mean temperature, specific cutting energy and surface finish are analyzed and compared for various amount of coolant.

## 2. Machining Characteristics and Multiple Comparisons

In Eq. (1) the temperature change of a tool ( $\Delta T$ ) is defined as the difference between the temperature at the beginning of cutting ( $T_0$ ) and the temperature after an elapse of 5 seconds ( $T_5$ ).

$$\Delta T = T_5 - T_0 \quad (1)$$

Specific cutting energy is defined as cutting energy per unit time or cutting energy per unit volume as shown in Eq. (2). It is the most widely adopted parameter for evaluation of machining characteristics based on cutting conditions (Jawahir et al., 1992).

$$u = \frac{F_y V}{f d V} = \frac{F_y}{f d} \quad (2)$$

where  $u$  is specific cutting energy,  $F_y$  is principal cutting force (N),  $V$  is the cutting velocity, (m/min),  $f$  is feed (mm/rev),  $d$  is depth of cut (mm).

From an analysis of variance (ANOVA) test, it can be concluded either 1) all population means are equal, or 2) at least one of the population means are not equal. However, at this stage, it is not possible to determine whether the difference among means of population is significant or not. Multiple comparison methods are employed in Statistics to investigate this magnitude of the difference among population means (Hochberg and Tamhane, 1987).

Tukey's honestly significant difference (HSD) method, Scheffe's method, Bonferroni method, Fisher's LSD, Newman-Keuls test and Duncan's method are multiple comparison methods (Hochberg and Tamhane, 1987). Especially Tukey's HSD, applying error rate for each experiment, was devised under the assumption that repetitions are identical. Therefore, it is exact when all factor level sample sizes are equal (Neter et al., 1996). This procedure has convenience of using the measure of a constant to test all pairs of treatment means. HSD is expressed as shown in Eq. (3) where  $S^2$  is the mean square of error with  $v$  degrees of freedom and  $n$  sample size.

$$HSD = q(\alpha; t, v) \sqrt{S^2/n} \quad (3)$$

where  $q(\alpha; t, v)$  is the  $100(1-\alpha)$  percentile in the distribution of a studentized range of  $t$  independent observations with  $v$  degrees of freedom and is number of samples. If the absolute value of the difference of two means is greater than HSD, then it indicates clear evidence that two treatments result in a significant difference.

### 3. Experimental Results and Analysis

An engine lathe was used for turning operation. The cutting tool and tool holder used are CNMG120404 MC TT 1500 (Daegutec) and PCLNR2020 K 12 (Daegutec) respectively. The workpiece material is structural carbon steel SM45C.

Table 1 shows the experimental conditions; 3 levels of coolant mix ratio (2, 6, and 10%), and 4 levels of coolant amount (none, 0.5 L/min, 1.0 L/min, and 2.0 L/min). The coolant used in

**Table 1** Cutting conditions

Cutting parameter	1	2	3	4
Mix ratio (%)	2	6	10	
Coolant (l/min)	None	0.5	1.0	2.0
Cutting speed, $V$ (m/min)	80	140	200	
Feed rate, $F$ (mm/rev)	0.15	0.20	0.25	
Depth of cut, $D$ (mm)	0.5	1.0	1.5	

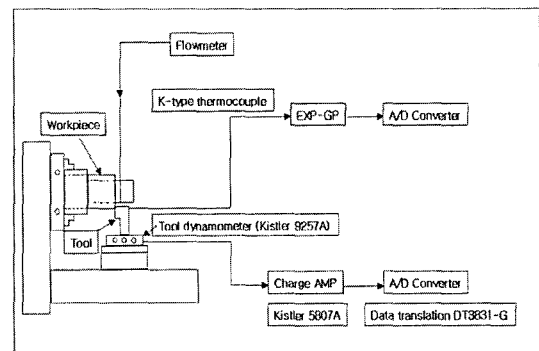
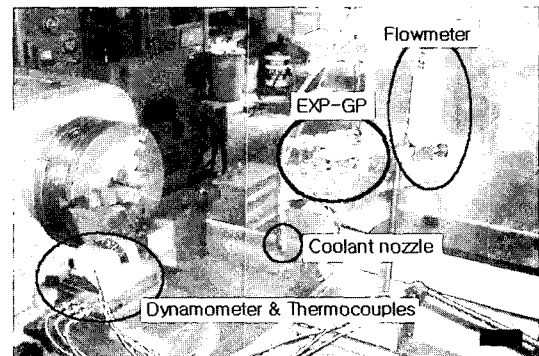

**Fig. 1** Experimental setup

the present work mainly consist of mineral oil and some extreme pressure additives. Three cutting parameters (cutting speed, feed rate, and depth of cut) are also set to 3 levels as shown in Table 1. Consequently, the total number of experiments is 270. Fig. 1 shows schematic diagram of experimental setup with a flow meter.

**3.1 Cutting tool temperature**

Figure 2 shows temperature ( $\Delta T$ ) defined in Eq. (1) at the cutting speed of 140 m/min for various other conditions. It is observed that, the machining without coolant produces significantly higher temperature compared to other levels of coolant amount used. On the other hand, from Fig. 2(a) (i), (ii) and (iii) it is observed that coolant amount do not seem to result in large differences in temperatures. Therefore the graphs at different levels of coolant amount is not shown for other cases. Also it is observed that the coolant mix ratio does not have much influence on the temperature. To represent a more meaningful statistical result, ANOVA-test for the cutting speed of 140 m/min is performed. The ANOVA result is summarized in Table 2. Test statistic  $F_0$  for  $F$  test is greater than the rejection region 2.04 at the significance level  $\alpha=0.05$ . It signifies that the null hypothesis should be rejected ;  $H_0 : \alpha_1 = \alpha_2 = \alpha_3 = \dots = \alpha_{10} = 0$  or  $H_0 : \alpha_a^2 = 0$ . In other words, factor level means are not equal at the significance level of 0.05, and thus the amount of coolant definitely affects the temperature of a cutting tool.

The ANOVA table tells us that there are differences in temperatures based on quantity of coolant alone. However, it does not specify which coolant level causes a significant difference in a temperature. From the graphs in Figures 2(a) to (i), it is observed that, there is differences in average temperatures for each coolant mix, however it does not specify the effect of individual coolant levels. Tukey method of multiple comparisons using HSD is employed to investigate which coolant level makes a large difference in temperatures. Tukey's HSD result is summarized in Table 3.

If the average difference in value (i.e. tempera-

ture) of each factor or treatment is larger than HSD, it is concluded that the factor level has significance in the test result. As it evident from Table 3, coolant level "Dry" has noticeable influence, and mix ratio "Dry" and "Wet" show some difference. In addition, coolant level "Dry" and "2 L/min" exhibit some significance. Finally, cutting speed also demonstrates the same

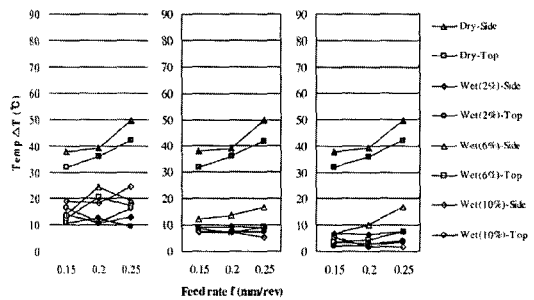

(i) Dry & 0.5 L/min (ii) Dry & 1.0 L/min (iii) Dry & 2.0 L/min  
(a) At 0.5 mm depth of cut

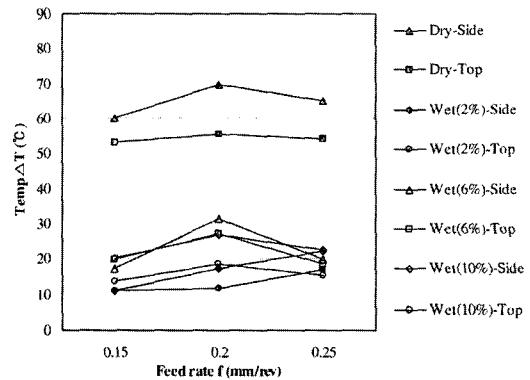

(b) Dry and 0.5 L/min coolant at 1.0 mm depth of cut

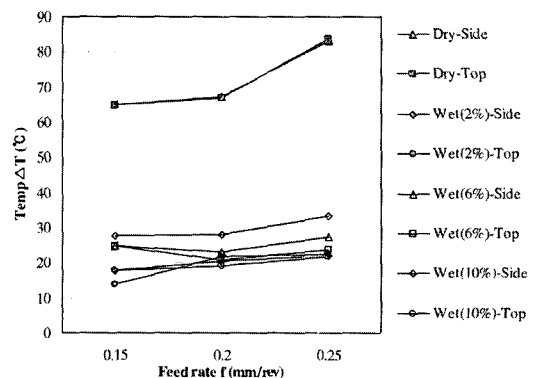

(c) Dry and 0.5 L/min coolant at 1.5 mm depth of cut

**Fig. 2** Temperatures ( $\Delta T$ ) at 140 m/min cutting speed



**Table 4** ANOVA table of coolant at constant velocity (140 m/min)—values of specific cutting energy at DOC 1.5 mm

	S	D.O.F	V	$F_0$	F(0.05)
Coolant	168842	9	18760.2	0.39393	2.04
Error	3809863	80	47623.3		
Total	3978705	89			

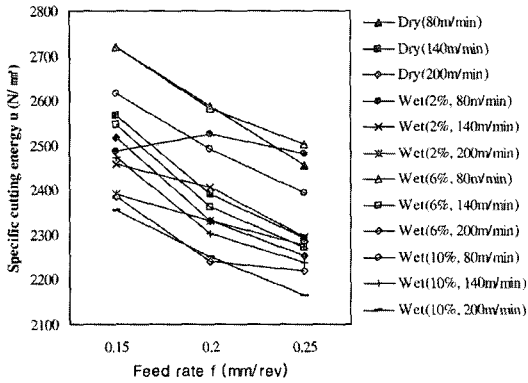
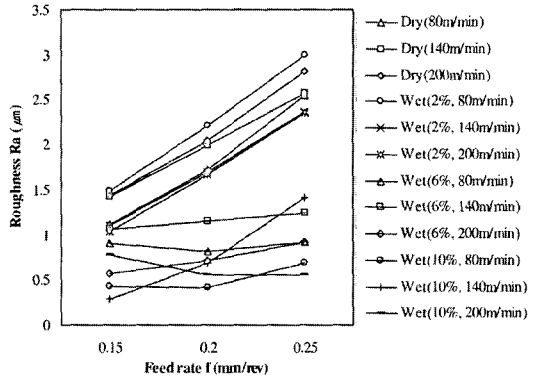

**Fig. 3** Specific cutting energy at 1.5 mm depth of cut and dry & 0.5 L/min coolant levels

$F_0$  for  $F$  test is smaller than the rejection region 2.04 at the significance level  $\alpha=0.05$ . It signifies that the null hypothesis cannot be rejected. In other words, there is no convincing evidence to believe factor level means are not equal at the significance level of 0.05. Therefore, the specific cutting energy does not change even if no coolant is used in the cutting process.

**3.3 Surface finish**

Figure 4 shows graphs illustrating the value of surface roughness at 1.5 mm depth of cut for different cutting conditions. It is observed from Fig. 4(a), (b) and (c) that at dry condition the surface roughness increased significantly as the feed rate is increased. As the cutting speed is increased the roughness of the surface is also increased. By using 2% coolant mix ratio, the surface roughness values decreased, however the improvement is not considerable. On the other hand, when the mix ratio is increased to 6% there is significant improvement in the surface quality. Further it is also observed from these graphs that by increasing the amount of coolant



(a) Dry and 0.5 L/min coolant

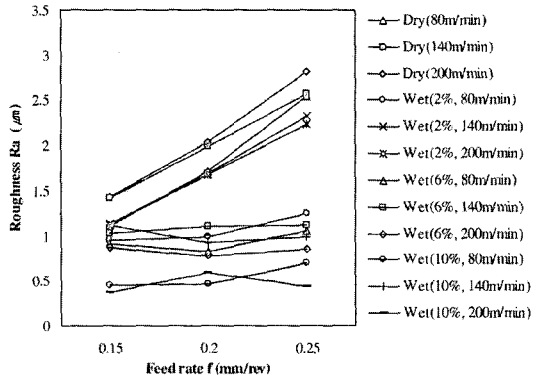

(b) Dry and 1.0 L/min coolant

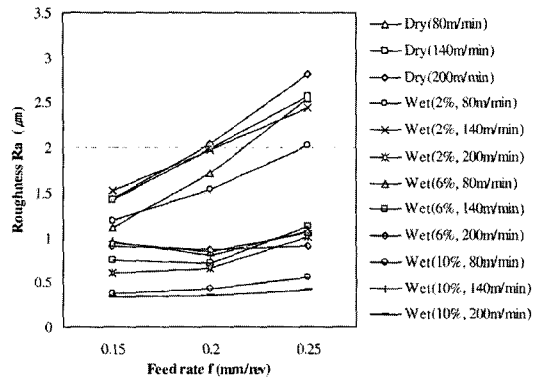

(c) Dry and 2.0 L/min coolant

**Fig. 4** Surface roughness ( $R_a$ ) at 1.5 mm depth of cut

mix ratio to 10%, the roughness value decreases but not significantly.

Subsequently, ANOVA-test for the cutting speed of 140 m/min is performed for a meaningful statistical result. The ANOVA-test results are presented in Table 5. In Table 5 it is seen that, the test statistic  $F_0$  for  $F$  test is larger than the



ther investigate which coolant level causes a significant difference in the tool temperature and surface finish. In the aspect of the tool temperature the minimum coolant level was 2%-1.0 L/min, which does not show significance. On the other hand, in the aspect of the surface finish, coolant level of 6%-0.5 L/min was selected for minimal use of coolant. Finally it is observed that, the current coolant use of 10%-2.0 L/min can be safely reduced to almost half, 6%-1.0 L/min, in order to achieve the same surface finish quality, without a sharp rise of cutting tool temperature. The reduction of coolant amount in a machining process will undisputedly reduce manufacturing cost and biological hazard to human health. Minimal use of coolant will eventually make the turning process a more environment-friendly manufacturing process.

### **Acknowledgment**

This work was supported by the Brain Korea 21 project in 2004.

### **References**

- Aronson, R. B., 1994, "Why Dry Machining," *Manufacturing Engineering*, Vol. 114, pp. 33~36.
- Byrne, G. and Scholta, E., 1993, "Environmentally Clean Machining Process — a Strategic Approach," *Annals of the CIRP*, Vol. 42, No. 1, pp. 471~474.
- Hochberg, Y. and Tamhane, A. C., 1987, "Multiple Comparison Procedures," *John Wiley and Sons Inc.*, New York.
- Jawahir, I. S., Qureshi, N. and Arsecularatne, J. A., 1992, "On the Interrelationships of some Machinability Parameters in Finish Turning with Cermet Chip Forming Tool Inserts," *Int. J. Mach Tools Manufacture*, Vol. 32, No. 5, pp. 709~723.
- Neter, J. et al., 1996, "Applied Linear Statistical models, 4th ed," Irwin, Chicago.
- Yang, S. H., Lee, Y. M., Kim, H. S. and Ko, T. J., 2003, "Temperature Variation Analysis of A Coolant Level using Multiple Comparison for Green Process," *Int. J. of Modern Physics B*, Vol. 17, No. 8-9, pp. 1388~1394.