

## Theoretical and Experimental Studies on Boiling Heat Transfer for the Thermosyphons with Various Helical Grooves

**Kyuil Han**

*School of Mechanical Engineering, Pukyong National University,  
San 100, Yongdang-dong, Nam-ku, Pusan 608-739, Korea*

**Dong-Hyun Cho\***

*Department of Computer Applied Mechanical Design Engineering, Daejin University,  
Sundang-Dong, Pocheon-City, Kyonggi-Do 487-711, Korea*

Boiling heat transfer characteristics of a two-phase closed thermosyphons with various helical grooves are studied experimentally and a mathematical correlation is developed to predict the performance of such thermosyphons. The study focuses on the boiling heat transfer characteristics of two-phase closed thermosyphons with copper tubes having 50, 60, 70, 80, 90 internal helical grooves. A two-phase closed thermosyphon with plain copper tube having the same inner and outer diameter as those of grooved tubes is also tested for comparison. Water, methanol and ethanol are used as working fluid. The effects of the number of grooves, various working fluids, operating temperature and heat flux are investigated experimentally. From these experimental results, a mathematical model is developed. In the present model, boiling of liquid pool in the evaporator is considered for the heat transfer mechanism of the thermosyphons. And also the effects of the number of grooves, the various working fluids, the operating temperature and the heat flux are brought into consideration. A good agreement between the boiling heat transfer coefficient of the thermosyphon estimated from experimental results and the predictions from the present mathematical correlation is obtained. The experimental results show that the number of grooves, the amount of the working fluid and the various working fluids are very important factors for the operation of thermosyphons. Also, the thermosyphons with internal helical grooves can be used to achieve some inexpensive and compact heat exchangers in low temperature.

**Key Words :** Boiling, Internal Helical Grooves, Heat Transfer Coefficient, Thermosyphon, Evaporator

### Nomenclature

$A$  : Surface Area ( $m^2$ )  
 $b$  : Distance between grooves (m)  
 $c_p$  : Specific heat ( $J/kg \cdot K$ )  
 $D_i$  : Inside diameter (m)

$e$  : Height of groove (m)  
 $g$  : Gravitational acceleration (m/s)  
 $h$  : Heat transfer coefficient ( $W/m^2 \cdot K$ )  
 $h_{fg}$  : Latent heat of vaporization ( $J/kg$ )  
 $k$  : Thermal conductivity ( $W/m \cdot K$ )  
 $L$  : Length of thermosyphon (m)  
 $m$  : mass flow rate (kg/s)  
 $P$  : Pressure (Pa)  
 $Q$  : Heat transfer rate (W)  
 $q$  : Heat flux ( $W/m^2$ )  
 $T$  : Temperature (K)

\* Corresponding Author,

E-mail : chodh@daejin.ac.kr

TEL : +82-31-539-1973; FAX : +82-31-539-1970

Department of Computer Applied Mechanical Design  
Engineering, Daejin University, Sundang-Dong,  
Pocheon-City, Kyonggi-Do 487-711, Korea. (Manus-  
ript Received August 19, 2004; Revised June 28, 2005)

$\Delta T$  :  $T_w - T_1$  (K)

$w$  : Width (m)

**Greek Letters**

$\rho$  : Density ( $\text{kg}/\text{m}^3$ )

$\mu$  : Dynamic viscosity ( $\text{N}\cdot\text{s}/\text{m}^2$ )

$\phi$  : Liquid fill charge ratio (%)

**Subscripts**

atm : Atmosphere

avg : Average

c : Condenser

e : Evaporator

hot : Heating water

i : Internal

in : Inlet

l : Liquid

out : Outlet

p : Plain

sat : Saturated

v : Vapor

w : Wall

**1. Introduction**

A two-phase closed thermosyphon is a high performance heat transfer device which is used to transfer a large amount of heat rate with a small temperature difference by evaporation of working fluid through the evaporation section and condensation in the condenser section. Two-phase closed thermosyphon has many advantages such as a large amount of heat transfer capability using latent heat, uniform temperature distribution by vapor flow's heat diffusion, light and simple structure, fast heat response characteristics.

Therefore, thermosyphons are being used in many applications such as : heat exchangers, cooling of electronic components, solar energy conversion, spacecraft thermal control, cooling of gas turbine rotor blades and etc.

A considerable experimental and theoretical work had been done on the application and design modifications for the two-phase closed thermosyphon performance. The influences of the filling ratio, inclination angle, heat flux and operating pressure on the heat transfer performance of a two-phase closed thermosyphon for a different

working fluids had been studied (Sarhan, 2000 ; Kim et al., 2003 ; Shalaby et al., 2000). Terdtoon et al.(1996) investigated the effect of aspect ratio and Bond number on the heat transfer characteristics of an inclined two-phase closed thermosyphon. The heat transfer in a vertical annular two-phase closed thermosyphon had been studied experimentally by Abdel-Aziz (1996). The effects of heat flux, liquid fill charge ratio and evaporator to condenser length ratio on the heat transfer coefficient were investigated. Hideaki et al.(1999) and Chen et al.(2004) performed an experimental investigation on the effect of heat flux, inside pressure, type of working fluid, amount of liquid filling ratio and the dimensions of a thermosyphon tube on the occurrence of geysering. Imura et al.(1997) performed an experimental study of critical heat flux in a double tube two-phase closed thermosyphon. They investigated the effects of the tube diameter, evaporator length, working fluid, fill charge ratio and inside temperature on the critical heat flux.

Plain tube was used in most of those studies and only a few research was performed using internal grooved tube. Heat pipe with internal triangular shaped groove was analyzed by Peterson and Ma (1996). A large enhancement on heat transfer rate is expected in thermosyphon when internal grooved tube is used. Boo et al.(1988) carried out a research on the thermosyphon with internal grooves.

In this work, experimental studies on vertical thermosyphons with internal helical grooves have been carried out. The thermosyphons with internal helical grooves can be used to achieve some inexpensive and compact heat exchangers in low temperature. The heat transfer mechanisms at the evaporator were investigated experimentally and a correlations which includes the effects of the helical grooves, the operating pressure, the heat flux was developed.

**2. Experimental Apparatus and Method**

Fig. 1 shows the schematic diagram of the experimental apparatus. It consists of five parts

such as test section, cooling water circulation line, heating water circulation line, high vacuum system, temperature measurement and recording system. The geometric specification of the plain and grooved thermosyphon is shown in Table 1. Fig. 2 shows a cross-sectional view of helical grooved thermosyphon. Enlarged cross sectional view of internal groove (20 times) is shown in Fig. 3. Test section of the thermosyphon is illustrated in Fig. 4. The total length of the thermosyphon is 1200 mm. It consists of evaporation and condensation section with 550 mm in length respectively and adiabatic section with 100 mm in length. The test tube has a 14.3 mm inner diameter

and a 15.8 mm outer diameter. Two 550 mm long water jackets are set on the test thermosyphon.

One is used as a heating jacket for an evaporator and the other is used as a cooling jacket for a condenser. An inlet small tube for heating or cooling water flow into each jacket is directed at a tangent to the inside surface of the jacket.

The thermosyphon can be positioned with any inclination angle from 0° to 90° with respect to

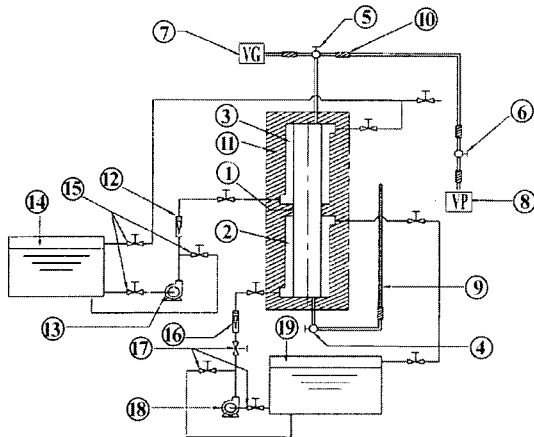

1. Test Tube 2. Heating Water Chamber 3. Cooling Water Chamber 4. Vacuum Valve 5. Vacuum Valve 6. Vacuum Rubber Hose 7. Vacuum Gauge 8. Vacuum Pump 9. Measuring Device for Liquid Level 10. Vacuum Rubber Hose 11. Insulation 12. Coolant Flow Meter 13. Coolant Pump 14. Coolant Constant Temperature Bath 15. Coolant Control Valve 16. Heating Water Flow Meter 17. Heating Water Control Valve 18. Heating Water Pump 19. Heating Water Constant Temperature Bath

Fig. 1 Schematic diagram of experimental apparatus

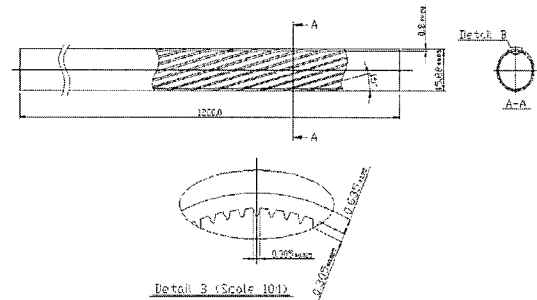

Fig. 2 Cross-sectional view of helical grooved thermosyphon

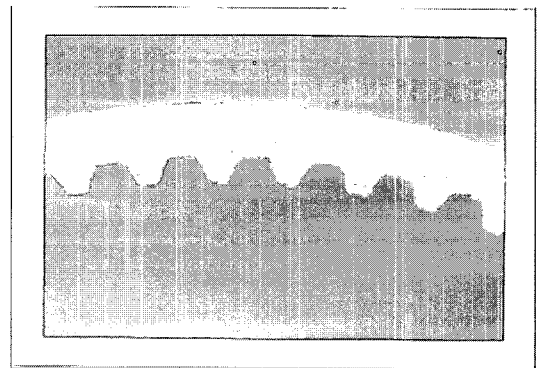

Fig. 3 Enlarged cross-sectional view of internal grooves (60 grooves)

Table 1 Geometric specification of helical grooved thermosyphons

Do (mm)	Di (mm)	L (m)	Grooves (No.)	e (mm)	w (mm)	b (mm)	A <sub>i</sub> (m <sup>2</sup> /m)	A <sub>i</sub> /A <sub>p</sub>
15.9	14.3	1.2	50	0.3	0.3	0.59	0.069	1.53
			60	0.3	0.3	0.44	0.073	1.63
			70	0.3	0.3	0.34	0.078	1.73
			80	0.3	0.3	0.26	0.082	1.83
			90	0.3	0.3	0.19	0.087	1.93

the horizontal position. Nine thermocouples are soldered on the outside surface of the tube along its length to measure surface temperatures. Another nine thermocouples are inserted into the inside of thermosyphon to measure inside vapor temperatures. Four more Pt. 100Ω temperature sensors are placed at the inlets and the outlets of two water jackets. The temperature outputs are recorded on a data logger and it is connected to a personal computer to analyze recorded data.

A rotary vacuum pump and a diffusion pump with a rating of 10<sup>-6</sup> Torr are used to remove air and other non-condensable gases. Water, methanol and ethanol are chosen as working fluids, since these are compatible with copper and materials to work with. Hashimoto et al.(1999) reported that the considerable decrease of conden-

sation heat transfer might be caused by the non-condensable gas. In order to eliminate the non-condensable gas, a little more than exact quantity of working fluid is injected into the tube after evacuating air.

After injecting the working fluid, heating and cooling water flow into the evaporator and the condenser jackets. A small amount of non-condensable gas was collected at the end of the condenser after a few minutes of operation. This gas is removed again by vacuum pump. All of the residual working fluid in the test tube was collected after each run of experiment and its volume was measured to determine the exact quantity of working fluid.

The experimental conditions are set as follows. The heating and cooling water temperature are varied. Two constant water temperature baths supply hot or cool water continuously within ±0.1°C difference for each setting temperature. The temperature distribution, heat flux, boiling heat transfer coefficients are obtained with respect to number of grooves, temperature changes of heating water or cooling water and working fluids.

An uncertainty analysis along the lines suggested by Kline and McClintock (1953) showed that the uncertainty due to measurement errors in the determination of  $q_e$  and  $q_c$  was about 3.5 and 4.7 percent, respectively. An uncertainty for the value of  $h_e$  at a ΔT of 4.5K is about 6.5 percent and that for the value of  $h_c$  at a ΔT of 2.8K is about 7.8 percent.

### 3. Results and Discussion

#### 3.1 Boiling heat transfer coefficient for the plain thermosyphon

The heat flow rate of boiling of working fluid is given by Eq. (1).

$$Q_e = m_e h_{fg} \tag{1}$$

The heat flow rate of hot water at evaporator zone is given by Eq. (2).

$$Q_{hot} = m_{hot} C_{p,hot} (T_{in} - T_{out})_{avg} \tag{2}$$

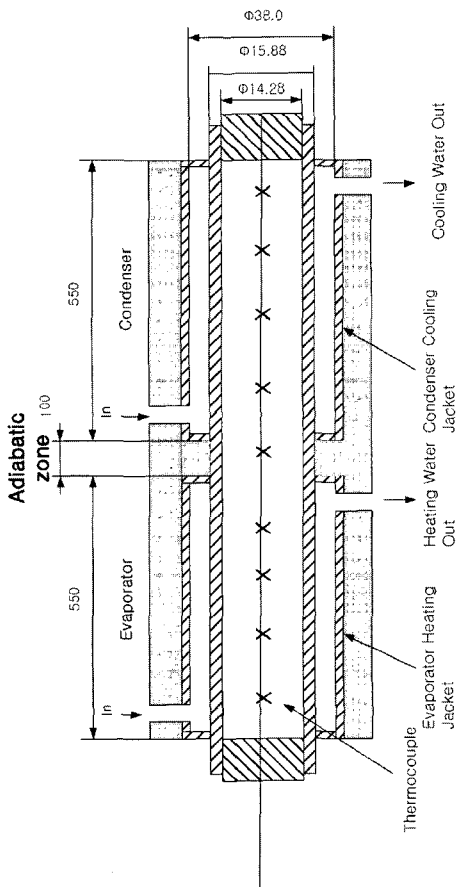

Fig. 4 Cross-sectional view of the experimental two-phase closed thermosyphon

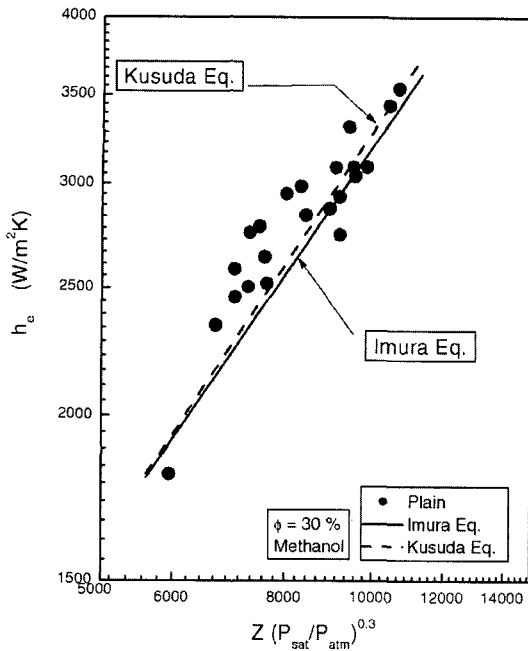

Fig. 5 Comparison of the experimental data with a correlation by Imura and Kusuda

and the experimental boiling heat transfer coefficient is given by Eq. (3).

$$h_e = \frac{(Q_{hot} + Q_e/2)}{A_e(T_w - T_i)_{avg}} \quad (3)$$

where  $A_e$  is nominal surface area.

Boiling heat transfer coefficients of plain thermosyphon are shown in Fig. 5.

All the data of plain thermosyphon is correlated well with Imura's (1997) and Kusuda's (1993) empirical correlation. Imura's correlation is represented below.

$$h_e = 0.32 Z \left( \frac{P_{sat}}{P_{atm}} \right)^{0.3} \quad (4)$$

where  $Z = \frac{\rho_l^{0.65} k_i^{0.3} C_{pl}^{0.7} g^{0.2} q_e^{0.4}}{\rho_v^{0.25} \mu_{fg}^{0.4} \mu_l^{0.1}}$

**3.2 Boiling heat transfer coefficients for the grooved thermosyphons**

The heat transfer process in the liquid pool is generally considered to be one of nucleate boiling. The boiling in the liquid pool differs somewhat from the well-known pool boiling because the boiling in the thermosyphon occurs in a cavity

Table 2 Parameters used in the experiments

Working fluids	Water, Methanol and Ethanol
Vapour pressure	$P_{sat} = 0.05 - 1.5$ bar
Heat flux of evaporator	$q = 10000 - 70000$ W/m <sup>2</sup>
Number of helical grooves	No. = 50, 60, 70, 80, 90 grooves
Heating water inlet temperature	$T_{hot} = 40^\circ\text{C} - 90^\circ\text{C}$

and the motion of the vapor bubbles in the liquid pool has a large effects on the heat transfer process. Purely theoretical study of the boiling in the evaporator is not possible due to the complexity of the process. Therefore, the heat transfer coefficient of the boiling was obtained empirically. The boiling in the two-phase closed thermosyphon is thought to be similar in heat transfer processes to the boiling which occurs in the open thermosyphon except for the operating pressure. Generally, the former occurs at a reduced pressure, the latter occurs at an atmospheric pressure. For the latter boiling, the empirical heat transfer coefficient which is based on dimensional analysis has been described in the literature (Imura et al., 1997). In this study, we applied their relation to the boiling of a closed thermosyphons with internal helical grooves. We assume that the heat transfer process is the same as that occurred in the open thermosyphon and the boiling heat transfer coefficient of a closed thermosyphons with internal helical grooves is given by :

$$h_e(\text{grooved}) \propto h_e(\text{open}) \cdot (P_{sat}/P_{atm}) \cdot \left( y_o + \frac{A}{w\sqrt{\pi/2}} e^{-2\frac{(x-x_o)^2}{ww}} \right) \quad (5)$$

where  $P_{atm}$  is the atmospheric pressure.

The experiments are conducted with five grooved thermosyphons, i.e., 50, 60, 70, 80, 90 helical grooves and three working fluids. The parameters and their ranges of working conditions are presented in Table 2.

From the experimental results, it is found that the ratio  $h_e(\text{grooved})/h_e(\text{open})$  increases with vapor pressure in the following relationship :

$$\frac{h_e(\text{grooved})}{h_e(\text{open})} \propto (P_{\text{sat}}/P_{\text{atm}})^{0.39} \quad (6)$$

as shown in Fig. 6. It is also reaffirmed that the temperature difference  $\Delta T$  and heat flux  $q$  have little effect on the ratio  $h_e(\text{grooved})/h_e(\text{open})$ .

From the experimental results, it is found that the ratio  $h_e(\text{grooved})/h_e(\text{Imura' eq.})$  correlates with  $b/D_i$  as shown in the Fig. 7. This trend is dependent on the condenser zone of thermosyphon. At the higher groove densities much or all of the intergroove space was filled condensate. This is thought to be the reason for the fall off

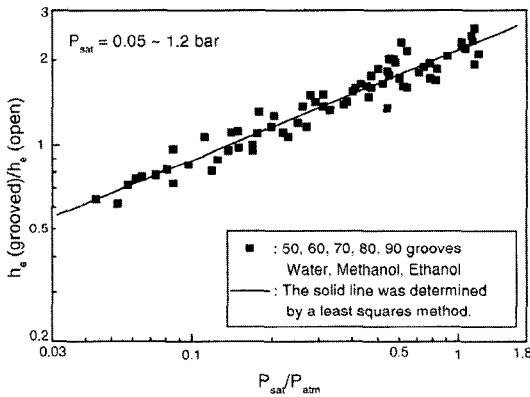

Fig. 6 Effects of the operating pressure on heat transfer coefficients. The solid line was determined by a least squares method

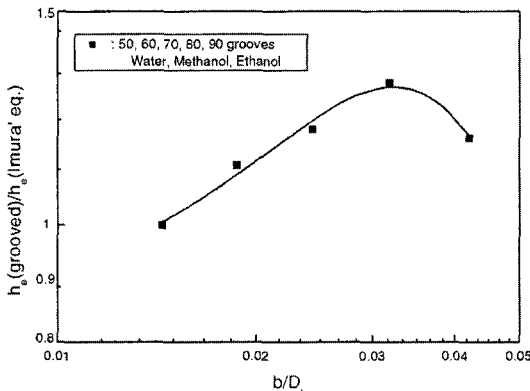

Fig. 7 Effects of the grooves on heat transfer coefficients. The solid line was determined by a least squares method

on condensation coefficient. The solid line was determined by a following relationship:

$$\frac{h_e(\text{grooved})}{h_e(\text{open})} \propto (0.8 + 0.5e^{-2774[(b/d_i) - 0.0332]^2}) \quad (7)$$

The heat transfer coefficient of the boiling in the two-phase closed thermosyphons with helical grooves was obtained as follows:

$$h_e = 0.53 \cdot Z \left( \frac{P_{\text{sat}}}{P_{\text{atm}}} \right)^{0.39} (0.8 + 0.5e^{-2774[(b/d_i) - 0.0332]^2}) \quad (8)$$

Fig. 8 shows a good agreement between the experimental results with equation (8) for the five grooved thermosyphons.

Figs. 9 and 10 show comparison of the experimental results with equations (4) and (8).

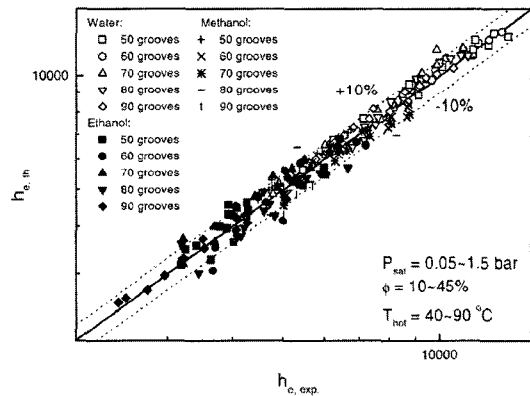

Fig. 8 Comparison of the experimental results with equation (8)

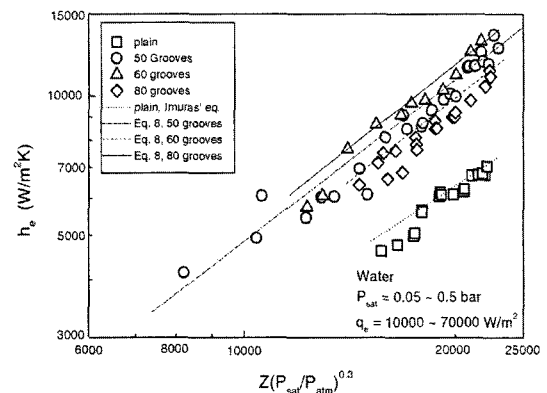

Fig. 9 Comparison of the experimental results with equations (4) and (8) for water

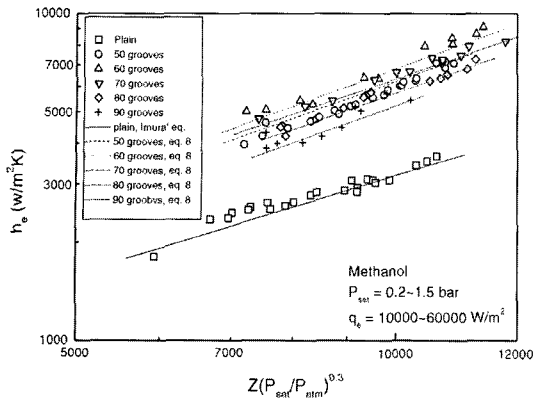

Fig. 10 Comparison of the experimental results with equations (4) and (8) for methanol

The experimental data are obtained with changes of heat input of evaporation section of the helical grooved thermosyphons. Boiling heat transfer coefficient increases with an increase of heat flux. All helical grooved thermosyphons show higher value than plain thermosyphon.

The best boiling heat transfer performance is obtained for 60 grooves, and the maximum value of this case is 2.2 times higher than that of the plain thermosyphon.

#### 4. Conclusions

In this study, plain thermosyphon and the thermosyphons having 50, 60, 70, 80, 90 internal helical grooves are investigated for the comparison of heat transfer performance of low temperature closed thermosyphons. Water, methanol and ethanol are used as working fluid.

The conclusions of this study can be summarized as follows :

(1) The boiling heat transfer coefficients of the plain thermosyphon was estimated from Imura's equation, in which it is agreed with the experimental values.

(2) A correlation predicts the heat transfer characteristics closely and the agreement with the experimental results is good.

(3) The best boiling heat transfer performance is obtained for 60 helical grooves, and the maximum value of this case is 2.2 times higher than that of the plain thermosyphon.

#### References

Abdel-Aziz, M., 1996, "Experimental Analysis of the Optimum Performance of Closed Vertical Thermosyphon Based on Geometry and Liquid Fill Rate Considerations," The 9<sup>th</sup> Int. Conf. For Mech. Power Eng., (ICMPE.9), Shebin El-Kom, Egypt, December, pp. 21~24.

Boo, J. H. and Jung, Y., 1988, "Experimentson the Thermal Performance of a Thermosyphon in Inner Grooved Copper Tube," *Proc. SAREK Summer Conf.*, pp. 313~317.

Chen, Y., Ding, X. and Yu, J., 2004, "Study on Heat Transfer Oscillation Phenomenon and Restraining Method of Two Phase Closed Thermosyphons," *13<sup>th</sup> International Heat Pipe Conference*, Vol. 2, pp. 305~310.

Hashimoto, H., Kaminaga, F. and Matsumura, K., 1999, "Study on Condensation Heat Transfer Characteristics in a Thermosyphon with Non-Condensable Gas Effect," *11<sup>th</sup> IHPC*, Vol. 1, pp. 121~126.

Hideaki, I., Kenji, I. and Shigetoshi, I., 1999, "An Experimental Investigation of Geysering in Two-Phase Closed Thermosyphons," *11<sup>th</sup> International Heat Pipe Conference-Tokyo*, Vol. 1, No. 1, pp. 166~171.

Imura, H., Kusuda, H., Ogata, J. I., Miyaz, T. and Sakamoto, N., 1997, "Heat Transfer in Two-Phase Closed-Type Thermosyphons," *Trans. of Japan Soc. of Mech. Engrs.*, pp. 485~493.

Kim, C. J., Yoo, B. O. and Park, Y., J., 2003, "An Experimental Study of a Closed Two-Phase Thermosyphon with Two Evaporators in Parallel Arrangement," *Proceeding of the the 7<sup>th</sup> International Heat Pipe Symposium*, Jeju, Korea, G-4.

Kline, S. J. and McClintock, F. A., 1953, "Describing Uncertainties in Single-Sample Experiments," *Mechanical Engineering*, Vol. 75, pp. 3~8.

Kusuda, H. and Imura, H., 1993, "Boiling Heat Transfer in an Open Thermosyphon," *JSME*, Vol. 16, No. 101, pp. 1734~1740.

Peterson, G. P. and Ma, H. B., 1996, "Experimental Investigation of the Maximum Heat Transport in Triangular Groove," *ASME J. of Heat*

*Transfer*, Vol. 35, No. 3, pp. 740~746.

Sarhaan, H. H., 2000, "Flow and Heat Transfer in Wickless Heat Pipe," *Ph.D Thesis*, Mansoura University.

Shalaby, M. A., Araid, F. F., Sultan, G. I. and Awad, M. M., 2000, "Heat Transfer Performance of a Two-Phase Closed Thermosyphon," *Proceeding of the the 6<sup>th</sup> International Heat Pipe*

*Symposium*, Chiang Mai, pp. 269~278.

Terdtoon, P., Ritthidej, S. and Shiraishi, M., 1996, "Effect of Aspect Ratio and Bond Number on Heat Transfer Characteristics of an Inclined Two-Phase Closed Thermosyphon at Normal Operating Condition," *Proceedings of the 5<sup>th</sup> International Heat Pipe Symposium*, Melbourn, Australia, pp. 261~266.