

# A New Inter-group Handoff Scheme in Micro/Pico Cellular System using Optical Fiber Feeder

Young uk Chung\* *Regular Members*

## ABSTRACT

To solve the cost problem of micro/picocell system, the fiber-optic cellular system was proposed. In this system, all channel elements are managed in Central Station, not in each base station. Also, all channel elements in a system can be dynamically assigned when the Spectrum Delivery Switch (SDS) is used. In this paper, we propose and analyze a new intergroup handoff scheme in the fiber-optic cellular system. The proposed scheme supports handoff with keeping current channel. Performance is evaluated with respect to the blocking probability and the handoff refused probability in both systems with SDS and without SDS. The numerical results show that the proposed scheme provides better performance than conventional soft handoff scheme.

Key Words : handoff; micro/picocell system; optical fiber feeder.

## I. Introduction

IMT-2000 system would reduce cell size based on microcell or picocell to provide multimedia services and support increasing users. By reducing cell size, we can increase the system capacity. The smaller cell size provides the smaller coverage area per base station (BS) and the physical network needs a large number of BS as well as a large infrastructure interconnecting the BS's. But the building of BS needs very high-cost. In view of communication services, cost must be kept low in order to acquire the mass consumer market.

To solve the cost problem of micro/picocell system, the fiber-optic cellular system was proposed<sup>[1]-[4]</sup>. The fiber-optic radio system is also called HFR (Hybrid Fiber Radio) system or optical-feeder system or bunch system. This system is composed of BS and Central Station (CS). The BS of this system is just a radio port such as a cheap dummy antenna. A BS is connected to CS using optical fiber network. To save cost, the existing optical network such as

CATV network can be used as the interconnection network between radio port and CS. It makes us install this system easily with very low-cost.

The radio signal from a mobile station (MS) is received at the BS. The received signal is converted into an optical RF signal at the BS and transmitted to the CS through the optical feeder. In the same way, the radio signal from the CS is transmitted to the BS through the optical feeder. All channel elements (CE's) including user data processing functions such as a modulator/demodulator, a channel encoder/decoder, and an interleaver/deinterleaver are installed and handled in a central station (CS). So, various radio channel controls, such as handoff control, dynamic channel assignment, or macrodiversity, can be done without complicated processing.

The CS controls connections between CE's and antenna ports and dynamically assigns traffic channels according to traffic demands by using such technologies as subcarrier multiplexing and spectrum delivery switching (SDS). Morita et al.<sup>[1]</sup> and Ohmoto et al.<sup>[2]</sup> showed that the centralized channel control with SDS improves system perfor-

\* Wireless team, Magnachip Semiconductor Ltd., Kangnam-gu, Seoul, Korea (thatfox@kaist.ac.kr)

논문번호 : KICS2005-01-044, 접수일자 : 2005년 1월 25일

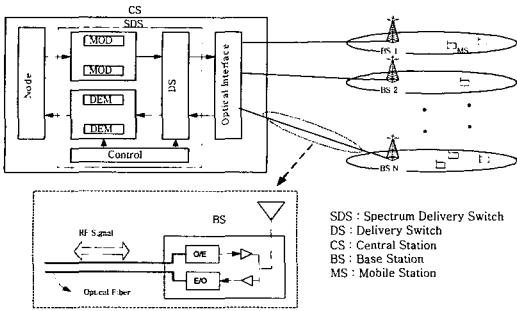

Fig 1. Fiber-Optic Cellular Radio System using SDS

mance in terms of blocking probability, handoff failure probability, and so on. The system with SDS is shown in Fig. 1.

The use of microcell/picocell gives more capacity, but this makes the increase of handoff in the system. Also there are many hot-spot cells because the traffic distribution is nonuniform. To solve these problems, the group simulcast technique was suggested<sup>[3]</sup>. By adjusting the simulcast group dynamically, the system can reduce handoff rates and protect the outbreak of hot-spot cell. Because all radio ports within a group broadcast and receive signals as if they are in the same cells.

This fiber-optic cellular system can be built based on both CDMA and TDMA methodology. Here, we consider a CDMA based system. The Intergroup handoff appears when a call is moved from one simulcast group to the other simulcast group. In the CDMA based fiber-optic microcell/picocell cellular system, IS-95 soft handoff scheme is usually used in intergroup Handoff. But the use of soft handoff scheme wastes so many CEs and induces heavy signal traffic for handoff. So, the modified handoff scheme suitable to the fiber-optic cellular system is needed.

This paper is organized as follows. In Section II, we proposed a new intergroup handoff scheme exclusive to the fiber-optic cellular system. In Section III, we describe the system model and analyze the system performance in view of blocking probability and handoff refused probability. In Section IV, we perform numerical analysis and discuss the results. Finally, we

summarize our results and make conclusions in Section V.

## II. Algorithm of the Proposed Scheme

In this section, we propose a new intergroup handoff scheme in the CDMA based fiber-optic microcell/picocell system. In the proposed scheme, a user continues to use his current channel even if a handoff occurs. This scheme uses the unique property of the fiber-optic cellular system such as central control of CE in the CS. In this system, a CS manages all channels of cells which are controlled by the CS. If a call occurs in a group, the CS allocates CE to the call. When the call is to be handoffed, the call sends a handoff request signal to the CS. When the CS receives the handoff request signal, it switches the occupied CE of the call from current group to target group. There is no difficulty to implement this switching behavior from the practical point of view. That is, the call is handoffed to target group with keeping its occupied CE. This algorithm is shown in Fig. 2.

The proposed scheme has many advantages. First, this scheme makes the system serve more users using the same CE. Because there is no soft handoff, this scheme can save CE with providing QoS level similar to soft handoff scheme. This scheme also provides lower handoff refused probability than soft handoff scheme. In conventional soft handoff scheme, a handoff call is

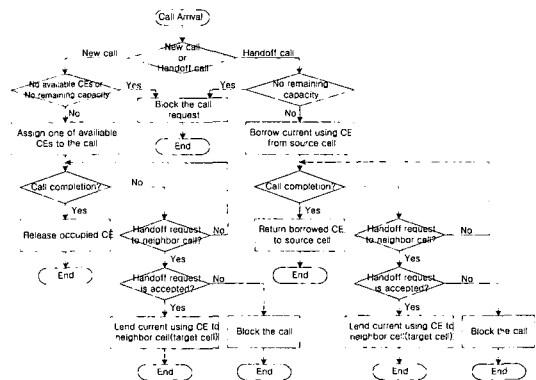

Fig 2. Proposed Handoff Algorithm

blocked in case that there is no CE in the target cell or group. But, in the proposed scheme, a call is handoffed to the target group with keeping its CE. So, there is no handoff call blocking if there is no interference limitation of capacity. Besides, the signal traffic for supporting handoff between radio port and CS can be diminished. The only signal traffic for supporting handoff is the handoff request signal from mobile to CS.

### III. System Modeling and Analysis

We analyze the proposed scheme for two systems. One is the system with SDS and the other is the system without SDS. To perform numerical analysis, we define that the system consists of simulcast groups which are controlled by a CS. We consider that there are no queues and no reserved channel for handoff calls.

#### 3.1 The System with SDS

In this system, we assume that there is no interference limitation. The total allowable channel of the system is assumed to be  $C$ . The new call arrival rate in a group is assumed to be Poisson distribution with rates  $\lambda_n$ . Let the call duration time be  $T_C$ . We assume that  $T_C$  is exponentially distributed with mean  $\mu_c^{-1}$ .

Using the birth-death process, we can derive the state transition diagram in view of total system which is shown in Fig. 3. The state of this process is defined as  $S(i)$  and  $i$  means the number of calls in a system which is controlled by a CS. Let  $P(i)$  be the steady-state probability. We define that total new call arrival rate in the system,  $\lambda_{in}$  is  $N \cdot \lambda_n$ , where  $N$  is the number of group in the system.

We evaluate the performance of proposed scheme in view of blocking probability and

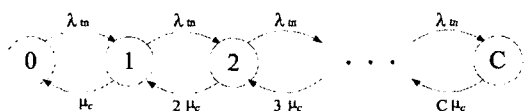

Fig 3. State-Transition Diagram of the SDS System

handoff refused probability. A new call is blocked when  $i = C$ , and the blocking probability is calculated from Erlang-B formula as

$$P_B = P(C) = \frac{\left(\frac{\lambda_{tm}}{\mu_C}\right)^C / C!}{\sum_{x=0}^C \left(\frac{\lambda_{tm}}{\mu_C}\right)^x / x!} \quad (1)$$

There is no handoff refused probability because we assume that there is no interference limitation in this system.

#### 3.2 The System without SDS

In this system, we assume that there are  $C_h$  channels initially assigned to each group. Also, we assume that there is interference limited capacity,  $C$  in each group. Let the handoff call arrival rate from neighbor groups be  $\lambda_n$ . Let the cell dwell time be  $T_d$  which is exponentially distributed with mean  $\mu_d^{-1}$ .

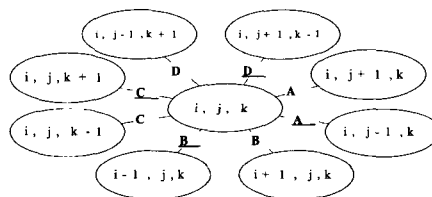

Fig 4. State-Transition Diagram of the non-SDS System

We can derive the state transition diagram in view of total system<sup>[5]</sup>. It is shown in Fig. 4. The state of this process is defined as  $s(i, j, k)$ , where  $i$  is the number of calls handoffed from neighbor cells,  $j$  is the number of calls originated in current cell, and  $k$  is the number of calls handoffed to neighbor cells.

There are four sets of state-transition rate. Each of those is symbolized by character from A to D. And,  $\bar{A}$  indicates the inverse transition of A. These sets are shown in Fig. 5. We define the transition to right direction be X1 and the transition to left direction be X2 if the set of transition is X. Then, each state-transition rate sets are defined as follows: A1 is a new call is originated in current group and A2 is a call in

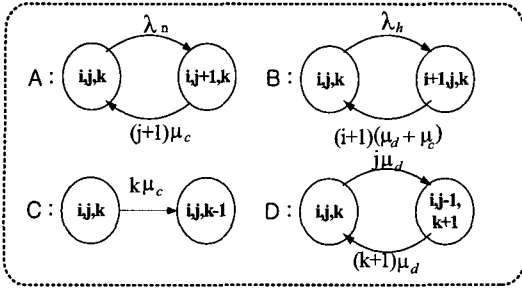

Fig 5. Set of State-Transition Rate of the non-SDS System]

current group is ended. B1 is a handoffed call from neighboring group is coming and B2 is a handoffed call from neighboring group is ended or handoffed to other group. C1 is a handoffed call from current group is ended. Finally, D1 is a call is handoffed to neighboring group and D2 is a handoffed call from current group is moving back to current group.

Let  $p(i,j,k)$  be the steady-state probability of  $s(i,j,k)$ . In this model, we assume that if a handoff call is expired, the channel is returned to its original group. Then, we can calculate the handoff call from neighbor groups arrival rate,  $\lambda_h$  as

$$\lambda_h = \sum_{i=0}^{C_h - G_h} \sum_{j=0}^{G_h} \sum_{k=0}^{C_h - j} (i+j) \cdot \mu_d \cdot p(i,j,k) + \sum_{i=C_h - G_h + 1}^C \sum_{j=0}^{C_h - i} \sum_{k=0}^{C_h - j} (i+j) \cdot \mu_d \cdot p(i,j,k) \quad (2)$$

We evaluate the performance of proposed scheme in view of blocking and handoff refused probability. A new call is blocked when all channels in the group are occupied or the interference limited capacity in the group is filled. And the blocking probability is given by

$$P_B = \sum_{j=0}^{C_h} \sum_{k=0}^{C_h - j - 1} p(i,j,k)|_{i=C_h - j} + \sum_{j=0}^{C_h} \sum_{i=0}^{C_h - j - 1} p(i,j,k)|_{k=C_h - j} \quad (3)$$

A handoff call is dropped only when the interference limited capacity in the group becomes full. And the handoff refused probability is given by

$$P_{hr} = \sum_{j=0}^{C_h} \sum_{k=0}^{C_h - j} p(i,j,k)|_{i=C_h - j} \quad (4)$$

#### IV. Numerical Results

Based on analysis results, we can calculate the numerical examples for two systems such as the system with SDS and the system without SDS. In each system, we calculate the numerical results of the proposed channel keeping handoff scheme and the soft handoff scheme. We use computer programmed iterative approach described in [6] to obtain numerical results.

##### 4.1 System with SDS

We investigate several numerical examples in case that  $\mu_c = 0.01$  and  $\mu_{dg} = 0.03$ . We calculate the numerical result of soft handoff scheme based on the state transition diagram of [7]. In the soft handoff scheme, we assume that handoff region dwell time is exponentially distributed with mean of 10 sec and the ratio of handoff region in the system is 0.3.

We perform the comparison of soft handoff scheme and proposed channel keeping handoff scheme. In this comparison, we assume that the system consists of five groups. Each group has 20 CEs. So, the CS has 100 CEs in the fiber-optic radio system. Also, in the soft handoff scheme, we assume that  $a=0.3$  and  $Q$  has the value of 0 and 10. These results are shown in Fig. 6. In these figures, CKHO and SHO means the proposed channel keeping handoff scheme and soft handoff scheme, respectively. From numerical results, we can see that the blocking and handoff refused probability of proposed scheme are lower than those of soft handoff scheme. A handoff call of the proposed scheme occupies only one channel even though that of soft handoff scheme occupies two channels. That's the reason that the proposed scheme has better performance with respect to not only handoff refused probability but also blocking probability. In this system, the handoff refused probability of proposed scheme is shown to be zero because of the assumption that the system has no interference limitation.

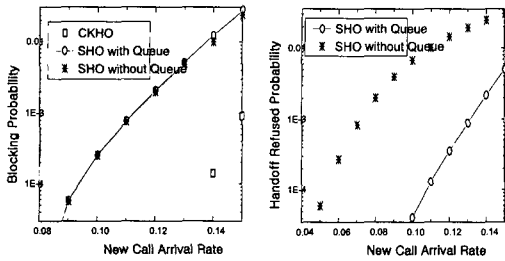

Fig 6. Comparison of Soft Handoff Scheme and Proposed Scheme in the SDS System: Blocking and Handoff Refused Probability vs. New Call Arrival Rate

### 4.2 System without SDS

In this system, the analysis model of soft handoff is the same as ordinary cellular system. So, we calculate the numerical result based on the state transition diagram of [5]. We evaluate the performance of the proposed channel keeping handoff scheme in this system. We consider two conditions. First condition is that the total number of initially assigned channel,  $C_h$  is changed when the interference limited capacity,  $C$  is fixed. In the second condition, we investigate numerical results with fixing the total number of initially assigned channel,  $C_h$  and varying the interference limited capacity,  $C$ . The results are shown in Fig. 7 through Fig. 8.

In the first condition, we analyze the blocking probability and handoff refused probability when  $C=30$ . From Fig. 7, we can see that the bigger the value of  $C_h$ , the lower the blocking probability. On the other side, as  $C_h$  is bigger, the handoff refused probability become higher. This phenomenon occurs because the bigger  $C_h$  makes the more capacity for new call and this

induces the smaller capacity for handoff call in the interference limited condition. In these results, the handoff refused probabilities when  $C_h$  is 20 and 25 have little difference. But in the case of blocking probability, the difference is relatively great. This means that the smaller the difference between  $C_h$  and  $C$ , the more the performance improvements under the situation of fixed  $C$ .

To investigate the performance in the case that  $C$  is changed, we assume the condition that  $C_h=20$ . In Fig. 8, we can see that the higher the value of  $C$ , the lower the blocking probability and the handoff refused probability. As the interference limited capacity is increased, the more handoff call from other cell can be serviced in this cell without disturbing new call arrival. So, both the blocking probability and the handoff refused probability have lower value. From these results, we can see that the blocking probability when  $C=30$  and  $C=40$  are alike, while the handoff refused probabilities of them have big difference. That's because  $C_h$  is fixed, and the total available offered load in this cell is limited.

We compare the numerical result of proposed scheme with that of soft handoff scheme. We investigate numerical example in the case of  $\mu_c=0.01$ ,  $\mu_d=0.03$ ,  $C_h=20$ , and  $C=30$ . The analysis condition of soft handoff scheme is the same as that of the system with SDS.

The numerical results are shown in Fig. 9. Numerical results show that the blocking and handoff refused probability of proposed scheme are lower than those of soft handoff scheme.

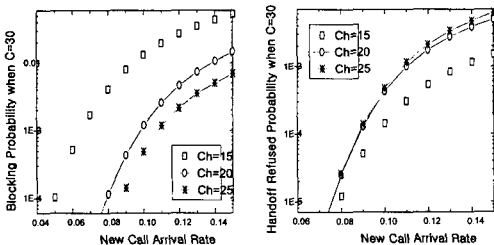

Fig 7. Proposed Scheme in the non-SDS System: Blocking and Handoff Refused Probability vs. New Call Arrival Rate with varying  $C_h$

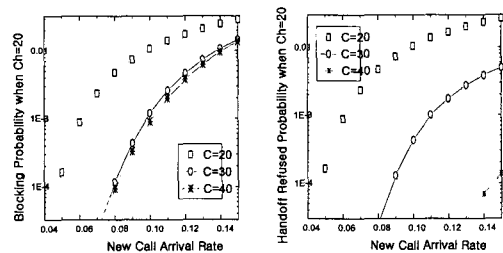

Fig 8. Proposed Scheme in the non-SDS System: Blocking and Handoff Refused Probability vs. New Call Arrival Rate with varying  $C$

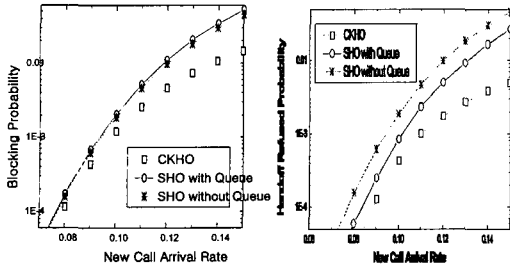

Fig 9. Comparison of Soft Handoff Scheme and Proposed Scheme in the non-SDS System: Blocking and Handoff Refused Probability vs. New Call Arrival Rate

### V. Conclusions

This paper proposed a new intergroup handoff scheme which is exclusive in fiber-optic cellular system. The proposed scheme has many advantages such as the increase of channel efficiency, the reduction of handoff refused probability, and the decrease of signal traffic for handoff. We analyzed the proposed scheme for two systems which are using SDS or not. Using the Markov chain, we performed system analysis in view of blocking probability and handoff refused probability. From numerical results, we can see that proposed handoff scheme has better performance than conventional soft handoff scheme in both the fiber-optic cellular systems with SDS and without SDS.

### References

[1] K. Morita and H. Ohtsuka, "The New Generation of Wireless Communication Based On Fiber-Radio Technologies," *IEICE Trans. Commun.*, Vol. E76-B, No. 9, pp.1061-1068, Sep. 1993.

[2] R. Ohmoto, H. Ohtsuka and H. Ichikawa, "Fiber-optic Microcell Radio System with a spectrum Delivery Scheme," *IEEE J. Select. Areas Commun.*, Vol. 11, No. 7, pp.1108-1117, Sep. 1993.

[3] S. Ariyavisitakul, T. E. Darcice, L. J. Greenstein, M. R. Philips and N. K. Shankaranarayanan, "Performance of Simucast Wireless Techniques for Personal Communi-

cation Systems," *IEEE J. Select. Areas Commun.*, Vol. 1, No. 4, pp.632-643, May 1996.

[4] S. Petterson, "A Comparison of Radio Resource Management Strategies in Bunched Systems for Indoor Communication," *IEEE VTC'99 Spring*, pp.402-406, May 1999.

[5] S. -L. Su, J. -Y. Chen and J. -H. Huang, "Performance Analysis of Soft Handoff in CDMA Cellular Networks," *IEEE J. Select. Areas Commun.*, Vol. 14, No. 9, pp.1762-1769, Dec. 1996.

[6] R. B. Cooper, *Introduction to Queueing Theory*, Second Edition Elsevier Science Publishing Co., Inc., 1984.

[7] Y. Chung and D.H. Cho, "Performance Analysis of Handoff Algorithm in Fiber-Optic Microcell/Picocell Radio System," *IEEE VTC'2000 Spring*, pp.2408-2412, May 2000.

Young uk Chung

*Regular Member*



Feb. 1997 B.S. in Electrical Engineering from KAIST  
 Feb. 1999 M.S. in Electrical Engineering and Computer Science from KAIST  
 Feb. 2003 Ph.D. in Electrical Engineering and Com-

puter Science from KAIST  
 Feb. 2003~Present Senior Engineer in Magnachip Semiconductor Ltd.

<Research Interests> Radio resource management and capacity analysis in wireless multimedia systems, 4G systems and wireless sensor networks.