

JPE 5-3-9

## Three-Phase PWM Inverter and Rectifier with Two-Switch Auxiliary Resonant DC Link Snubber-Assisted

Shinichiro Nagai\*, Shinji Sato\* and Takayuki Matsumoto†

†\*Sanken Electric Co., Ltd.

### ABSTRACT

In this paper, a new conceptual circuit configuration of a 3-phase voltage source, soft switching AC-DC-AC converter using an IGBT module, which has one ARCPL circuit and one ARDCL circuit, is presented. In actuality, the ARCPL circuit is applied in the 3-phase voltage source rectifier side, and the ARDCL circuit is in the inverter side. And more, each power semiconductor device has a novel clamp snubber circuit, which can save the power semiconductor device from voltage and current across each power device. The proposed soft switching circuits have only two active power semiconductor devices. These ARCPL and ARDCL circuits consist of fewer parts than the conventional soft switching circuit. Furthermore, the proposed 3-phase voltage source soft switching AC-DC-AC power conversion system needs no additional sensor for complete soft switching as compared with the conventional 3-phase voltage source AC-DC-AC power conversion system. In addition to this, these soft switching circuits operate only once in one sampling term. Therefore, the power conversion efficiency of the proposed AC-DC-AC converter system will get higher than a conventional soft switching converter system because of the reduced ARCPL and ARDCL circuit losses. The operation timing and terms for ARDCL and ARCPL circuits are calculated and controlled by the smoothing DC capacitor voltage and the output AC current. Using this control, the loss of the soft switching circuits are reduced owing to reduced resonant inductor current in ARCPL and ARDCL circuits as compared with the conventional controlled soft switching power conversion system. The operating performances of proposed soft switching AC-DC-AC converter treated here are evaluated on the basis of experimental results in a 50kVA setup in this paper. As a result of experiment on the 50kVA system, it was confirmed that the proposed circuit could reduce conduction noise below 10 MHz and improve the conversion efficiency from 88.5% to 90.5%, when compared with the hard switching circuit.

**Keywords:** soft switching, Auxiliary Resonant DC Link Snubber

### 1. Introduction

The high frequency switching power conversion

systems have got a great advancement based on high performance power semiconductor devices such as IGBTs, MOS-FETs, SITHs and IGCTs. Owing to the advancement, the power supplies, such as UPS, an inverter for an air conditioner system could achieve the most scaled down, low noise system in recent years. So, these power supplies could be settled in offices near the

---

Manuscript received April 13, 2005; revised June 3, 2005

†Corresponding Author: takmatsu@ms3.sanken-ele.co.jp

Tel: +81-492-66-8055, Fax: +81-492-66-4230

\*Sanken Electric Co., Ltd.

telecommunication system. However, the enlargement of switching losses and the electrical dynamic voltage and current stresses due to the advancement of power semiconductor devices,  $dv/dt$  and  $di/dt$  related EMI/RFI noises are incidental to high frequency switching in the power conversion systems. For saving the telecommunication system from the noise of the high frequency switching power conversion, we have settled for a noise filter, which is large scale and very expensive in power conversion systems today. And more, there is the heat problem. We must settle the cooling system issues in the power conversion systems because the switching losses will be the heat. This means that power efficiency and conversion ability could be lowered in the power conversion systems.

In this paper, the soft switching technique of 3-phase voltage source PWM converters and rectifiers has been picked up for the effective solution to solve these problems. The main purposes on the soft switching technology developments are to minimize the switching losses of switching power devices as well as to reduce the electrical dynamic voltage and current stresses by operation under principle of zero voltage soft switching (ZVS) and zero current soft switching (ZCS) schemes. For high performance such as high efficiency and low noises, these 3-phase voltage source converters and rectifiers, using the soft switching technique, are widely applied for the telecommunication energy conditioner. In general, the 3-phase voltage source soft switching PWM converters and rectifiers operating under ZVS condition are roughly divided into three categories; Auxiliary Resonant Commutated Pole Link (ARCPL), Auxiliary Resonant AC Link (ARACL) and Auxiliary Resonant DC Link (ARDCL).

In this paper, a new conceptual circuit configuration of a 3-phase voltage source soft switching AC-DC-AC converter using IGBT module, which has one ARCPL circuit and one ARDCL circuit, is presented. In actuality, the ARCPL circuit is applied on the 3-phase voltage source rectifier side, and ARDCL circuit is on the inverter side. And more, each power semiconductor device has the novel clamp snubber circuit, which can save the power semiconductor device from voltage and current across each power devices. The proposed soft switching circuits

have only two active power semiconductor devices. These ARCPL and ARDCL circuits consist of fewer parts than the conventional soft switching circuit. Furthermore, the proposed 3-phase voltage source soft switching AC-DC-AC power conversion system needs no additional sensor for complete soft switching as compared with the conventional 3-phase voltage source AC-DC-AC power conversion system. In addition to this, these soft switching circuits operate only once in one sampling term. Therefore, the power conversion efficiency of the proposed AC-DC-AC converter system will get higher than a conventional soft switching converter system because of the reduced ARCPL and ARDCL circuit losses. The operation timing and terms for ARDCL and ARCPL circuits are calculated and controlled by the smoothing DC capacitor voltage and the output AC current. Using this control, the loss of the soft switching circuits are reduced owing to reduced resonant inductor current in ARCPL and ARDCL circuits as compared with the conventional controlled soft switching power conversion system. The operating performances of proposed soft switching AC-DC-AC converter treated here are evaluated on the basis of experimental results in 50kVA setup in this paper.

## 2. Circuit Construction

The schematic configuration of 3-phase voltage source soft switching AC-DC-AC converter system is illustrated in Fig.1. On the AC-DC side, the rectifier has the Auxiliary Resonant Commutated Pole Link (ARCPL) circuit to achieve complete soft switching operations. The proposed ARCPL circuit consists of two active power semiconductor devices Q1 and Q2, two resonant inductors, six resonant capacitors in each phase active power semiconductor switching devices of rectifier main circuit, six diodes D1~D6 and two smoothing capacitors C<sub>fp</sub> and C<sub>fn</sub>. On the other hand, the Auxiliary Resonant DC Link (ARDCL) circuit is applied for the DC-AC 3-phase voltage source inverter side. The proposed ARDCL circuit has a resonant inductor L<sub>r</sub>, two active power semiconductor devices Q3 and Q4 and smoothing capacitor C<sub>f</sub> and six resonant capacitors in each phase active power semiconductor switching devices of inverter main circuit.

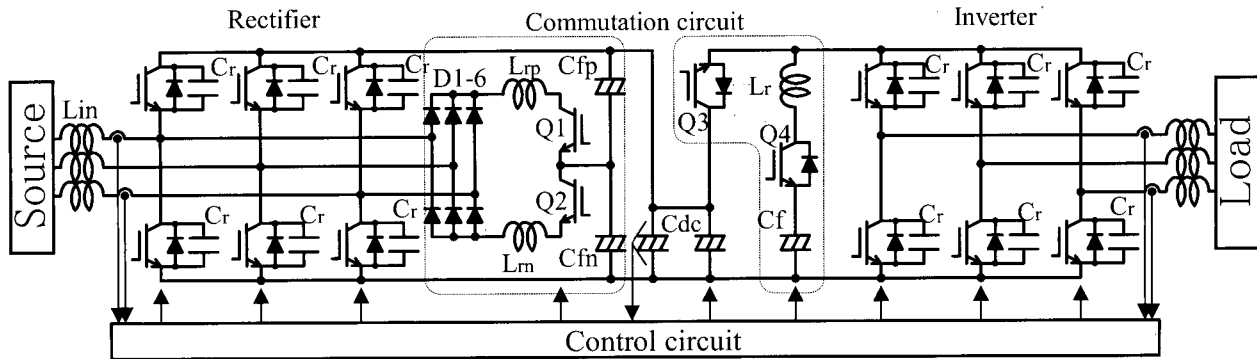

Fig.1. Configuration of circuit.

Using this ARCPL circuit and ARDCL circuit, Zero Voltage Soft-Switching(ZVS) or Zero Voltage & Zero Current hybrid Soft-Switching can be achieved in all main circuits of rectifier and inverter, and Zero Current Soft-Switching(ZCS) be in auxiliary switch Q1, Q2, Q3 and Q4. So, the switching power losses will be zero in ideal.

### 3. Operation Principle

#### 3.1 Rectifier Operation

The proposed soft switching rectifier system is controlled by the saw-tooth carrier wave-based PWM signal. To achieve complete soft switching transition in all power semiconductor devices, turn off transition is achieved in zero voltage soft switching by resonant capacitor \$C\_r\$ on the rectifier side. On the other hand, turn on transition is achieved in zero voltage and zero current hybrid soft switching operation by using additional commutation circuit (ARCPL). In Fig.2, the relation between the saw-tooth carrier waveform and the switching timing chart and operation waveforms of ARCPL circuit in case of turn on transition is illustrated.

The proposed ARCPL circuit operation starts before \$T\_1\$ from the saw-tooth carrier waveform reset. This term \$T\_1\$ is demonstrated in the equation (1). In this soft switching rectifier system, this term \$T\_1\$ is controlled by the DC side smoothing capacitor voltage \$V\_{dc}\$ and the smoothing capacitor current \$I\_{link1}\$. Using the calculated term \$T\_1\$, the losses of ARCPL circuit are effectively saved.

#### 3.2 Inverter Operation

The proposed soft switching inverter system is operated

by the same control method used on the rectifier side as shown in Fig.3. Using the proposed ARDCL circuit, all phase turn on transitions could achieve the zero voltage and zero current hybrid soft switching operation at the same time.

The proposed ARDCL circuit operation is controlled by the switching timing terms \$T\_3\$ and \$T\_4\$ for reducing the losses of the ARDCL circuit. These terms are demonstrated by equation (2) and (3). In these equations, \$I\_{link2}\$ indicates the DC side smoothing capacitor current.

$$T_1 = \frac{2 \cdot L_{rp} \cdot I_{link1}}{V_{dc}} + \pi \sqrt{L_r \cdot 4 \cdot C} \quad \dots\dots(1)$$

(\$I\_{link1}\$:Current of direction to \$V\_{dc}\$ from rectifier.)

$$T_3 = \frac{2 \cdot L_r \cdot I_{link2}}{V_{dc}} + \pi \sqrt{L_r \cdot 3 \cdot C} \quad \dots\dots(2)$$

$$T_4 = 2 \cdot \frac{2 \cdot L_r \cdot I_{link2}}{V_{dc}} + \pi \sqrt{L_r \cdot 3 \cdot C} \quad \dots\dots(3)$$

(\$I\_{link2}\$:Current of direction to \$V\_{dc}\$ from inverter.)

## 4. Experimental Results

### 4.1 Experimental Set-up

Figure 4 indicates the experimental set-up of the 3-phase voltage source soft switching AC-DC-AC converter system treated here. In this AC-DC-AC converter system, the input voltage is 200V, the output voltage is 200V, and the smoothing capacitor DC voltage

is 400V. And more, the sampling frequency is 16kHz, the input and output frequency is 50 kHz and the output power is 50kVA. Also, the resonant inductors  $L_r$ ,  $L_{rp}$ ,  $L_{m}$ , and the resonant capacitor  $C_r$  values are designed for minimizing the commutation terms for soft switching to 10% of the sampling frequency. In addition to this, the

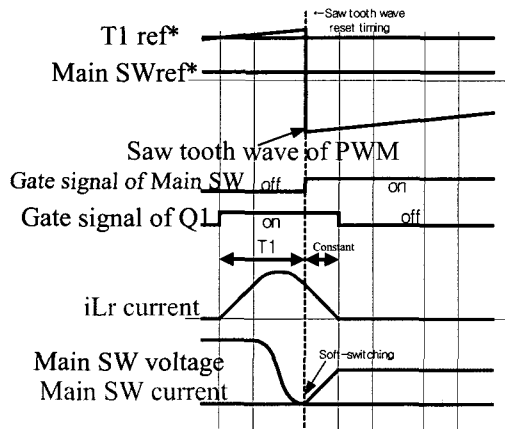

Fig. 2 Operation of Commutation for Rectifier

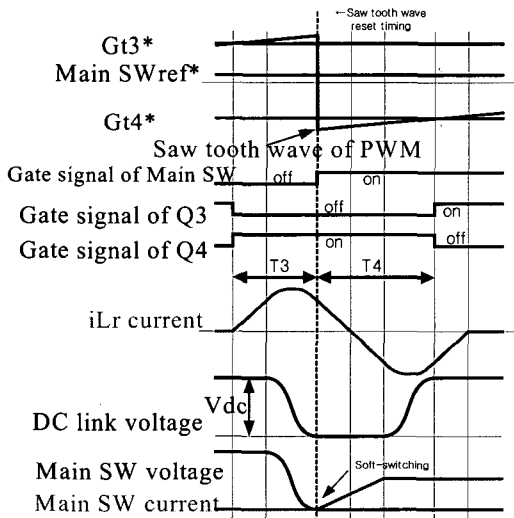

Fig. 3 Operation of Commutation for Inverter

clamp snubber circuit for saving the voltage is connected to each power semiconductor device on the rectifier side. However, if there is the same clamp snubber circuit in the inverter side, the loss of the clamp snubber will be enlarged in the soft switching terms. Therefore, a novel clamp snubber circuit which has the additional power diode suitable for ARDCL soft switching inverter

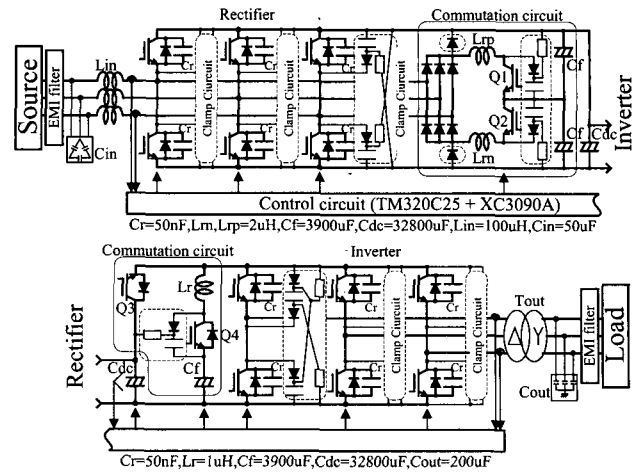

Fig. 4 Experimental circuit

has been proposed and applied on the inverter side as shown in Fig.4. For the auxiliary switches such as  $Q_1$ ,  $Q_2$ ,  $Q_4$  and power diode  $D_1$ ~ $D_6$ , the clamp snubber circuits are settled like Fig.4. The control circuit of the experimental set-up of the 3-phase voltage source soft switching AC-DC-AC converter system consists of DSP (TMS320C25) and logic IC (XC3090).

### 4.2 Circuit Construction

Figure 5 illustrates the picture of an experimental set-up of the rectifier side using IGBT modules. And Fig.6 illustrates the picture of the inverter side. And the total structure of the whole system is displayed in Fig.7. In this picture, the power line is formed by plane copper boards, because this construction could reduce the leakage inductance in the proposed AC-DC-AC converter system. In the complete system, the inverter and the rectifier circuits are arranged to the upper side in the structure because of its heat. Furthermore, the output filter trans and input inductors and the EMI filter is on the lower side and the control circuit is disposed inside the door as shown in Fig. 7.

## 5. Experimental Results and Discussions

### 5.1 Operation Waveforms

Figure 8 shows the observed voltage and current waveforms at soft switching turn on and turn off for the ARCPL soft switching rectifier main switch in the bridge arm. From these figure, significantly reduced  $dv/dt$  and

di/dt values in the soft switching rectifier main switches means that EMI/RFI noises can be reduced greatly from Fig.8. Furthermore, experimental waveforms for the

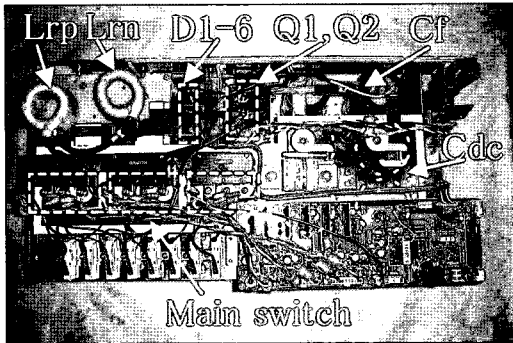

Fig. 5 Structure of Rectifier main circuit

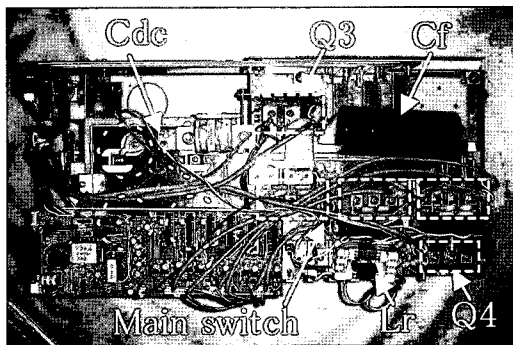

Fig. 6 Structure of Inverter main circuit

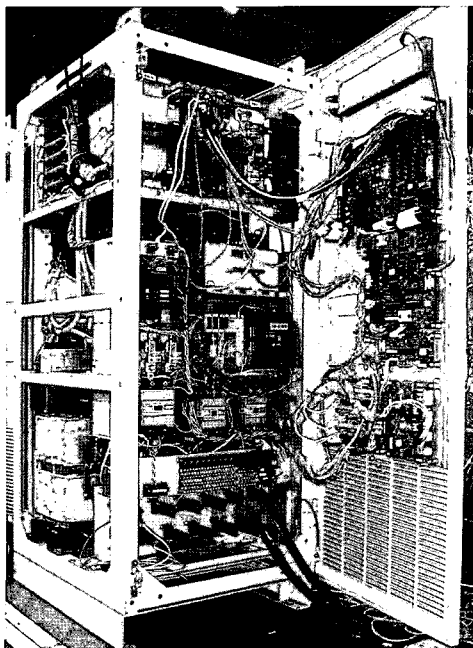
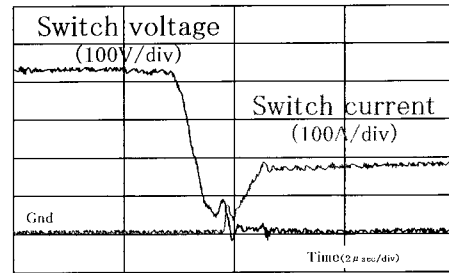
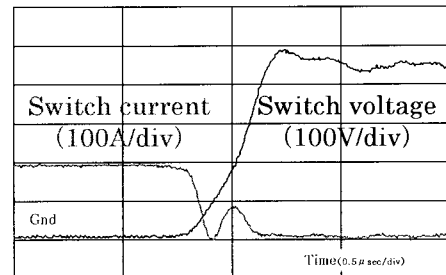

Fig. 7 Structure of all system



(a) Turn-on



(b) Turn-off

Fig. 8 Switching waveforms(Rectifier)

inverter main switches are shown in Fig.9. It is clear that the switching power device power losses of the proposed soft switching rectifier and inverter can be remarkably reduced because of the soft switching operation being achieved completely.

The input current and output current of the proposed 3-phase voltage source soft switching AC-DC-AC converter system is displayed in Fig.10. It is certain that this convert system can achieve power factor correction and sine wave current shaping.

### 5.2 Comparative Noise Data

In addition, comparative RFI noise measured from 100 kHz to 30MHz between soft switching and hard switching is shown in Fig.11. Under 10 MHz frequencies, RFI noise in soft switching is improved by about 5dB. However, the noise value in soft switching scheme is less than one in hard switching. The causes of the lower RFI noise are the additional commutation circuits for complete soft switching; the ARDCL, and ARCPL circuits. These additional circuits make the additional circuit loop in the proposed 3-phase AC-DC-AC power conversion system.

Furthermore, these additional circuit loops have the leakage inductance. So, in case of turn off transition, there is the surge because of the leakage inductance and the

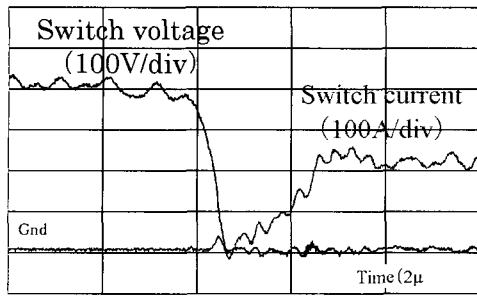

(a) Turn-on

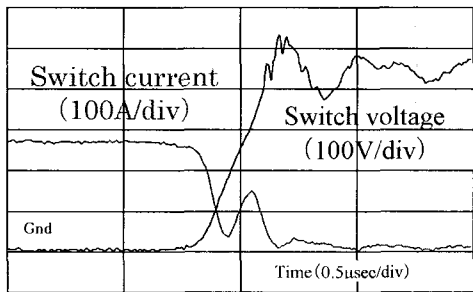

(b) Turn-off

Fig. 9 Switching waveforms(Inverter)

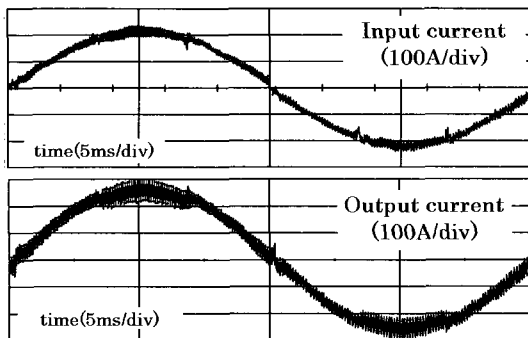

Fig. 10 Input current and Output current

capacitance of the active power semiconductor devices. To solve this problem, the proposed 3-phase AC-DC-AC soft switching power conversion system must adopt the Trench-Gate IGBT, which has less leakage inductance than the conventional one and the improved smoothing DC capacitor, which also has less leakage inductance.

**5.3 Comparative Efficiency Data**

The comparison data of efficiency between soft and hard switching is described in Fig.12. From this figure, it is clear that the efficiency in soft switching is higher than one in hard switching about 2.0% in all the power range 10~50kVA.

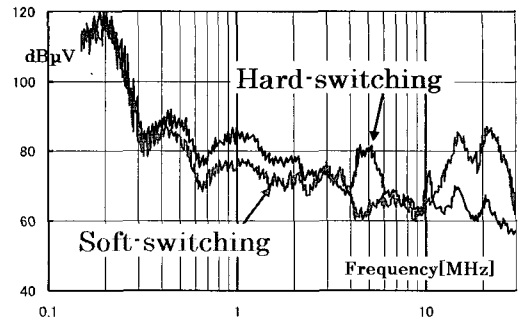

Fig. 11 Conduction noise spectrum

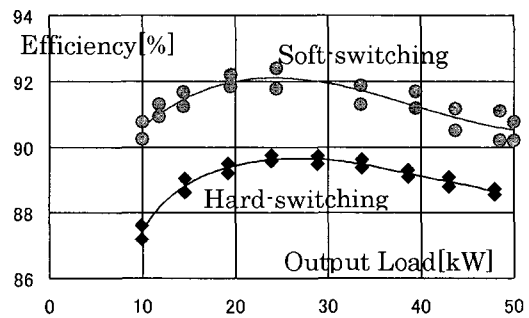

Fig. 12 Comparison of efficiency

**6. Conclusions**

In this paper, a new prototype topology of a 3-phase voltage source soft switching AC-DC-AC converter system suitable for the telecommunication energy conditioner has been proposed and discussed. The proposed ARCPL and ARDCL circuits consist of fewer parts than the conventional soft switching circuit. Because the switching loss is large, a switch of big capacity is needed though the number of switches of hard switching are little. Furthermore, the proposed 3-phase voltage source soft switching AC-DC-AC power conversion system needs no additional sensor for complete soft switching as compared with the conventional 3-phase voltage source AC-DC-AC power conversion system. So, it is clear that the proposed 3-phase voltage source AC-DC-AC soft switching power conversion system is effective from the cost point of views. In addition to this, a new conceptual control scheme suitable for ARCPL and ARDCL soft switching circuits has been proposed. Furthermore, a novel clamp snubber circuit, which has the additional power diode suitable for the soft switching scheme, has been proposed and applied in the proposed 3-phase voltage source AC-DC-AC soft switching power conversion system. It was proven from the feasible

experimental results that the complete soft switching operation in all the switching power semiconductor devices, IGBTs in both inverters and rectifiers. And more, 1.8% improvement in efficiency, lower noise, and 5dB saved in RFI noise is confirmed with the soft switching scheme. In addition to this, the loss of main circuit power semiconductor devices will reduce over half the value in case of soft switching method from power loss analysis. So the cooling systems of the proposed AC-DC-AC soft switching power conversion system are minimized. Also, the noise filter will be reduced in the soft switching conversion system because the noise is reduced in the soft switching method. To improve the proposed 3-phase voltage source AC-DC-AC soft switching power conversion system from both efficiency and noise point of views, the proposed 3-phase AC-DC-AC soft switching power conversion system must adopt the Trench-Gate IGBT module, which has lower saturation voltage than the conventional IGBT module. From these discussions, it is certain that the proposed AC-DC-AC soft switching conversion system is suitable for the telecommunication energy conditioner from not only efficiency but also a cost point of view. In the future, the advanced 3-phase voltage source soft switching AC-DC-AC converter system using the new power semiconductor devices such as Trench Gate PT-IGBTs, IGCTs, High Conductivity IGBTs (HiGTs) and IEGTs should be evaluated from a practical point of view. In the future, the advanced 3-phase voltage source soft switching AC-DC-AC converter system using the new power semiconductor devices such as Trench Gate PT-IGBTs, IGCTs, High Conductivity IGBTs (HiGTs) and IEGTs should be evaluated from a practical point of view.

## References

- [1] Shinichiro Nagai, Shinji Sato, Masayoshi Yamamoto, Mutsuo Nakaoka: "Noise Evaluation, Two Switch Resonant DC Link-Assisted Double Converter System and Commutation Control to Improve Loss." Proceedings of Industrial Electronics Society(IES). Industrial Electronics Conference-2002.
- [2] Shinji Sato, Yutaka, Suehiro, Shin-ichiro Nagai, Koichi Moritai: "High Efficiency Soft-Switching 3-phase PWM Rectifier" Proceedings of IEEE. International Telecommunication Energy Conference-2000, 25-1, pp.453-460.
- [3] Luigi Malesani, Paolo Tenti: "High Efficiency Quasi-Resonant DC Link Three-Phase Power Inverter for Full-Range PWM" IEEE Trans. on Ind. Appl., Vol.31, No.1, pp.141-147, 1995.
- [4] Yong C. Jung, Jung G. Cho and Gyu H. Cho: "A New Zero Voltage Switching Resonant DC-Link Inverter with Low Voltage Stress", IEEE-IECON, pp.308-313, 1991.
- [5] R.W. De Doncker "The Auxiliary Resonant Commutated Pole Converter", IEEE IAS Annual Meeting Records, pp.829-834, Oct. 1989.
- [6] M. Yoshida, E. Hiraki, M. Nakaoka: "Operating Evaluations of Three-Phase Voltage Source Soft Switching Inverter with A Single Commutation Type Resonant AC Link Snubber" Proceedings of IEE-Japan International Power Electronics Conference (IPEC)-Tokyo 2000, Vol.4, pp.1755-1759, April, 2000.



**Shinichiro Nagai** received his B.Sc.-Eng in Mechanical Engineering from Aoyama University in 1995 and joined as a research member in R&D of SANKEN Electric Co., Ltd. He has received a Ph.D. in Power Electronic Systems Engineering at Yamaguchi University, Yamaguchi, Japan. He is interested in soft switching inverter and rectifier systems, photovoltaic and wind power generation systems and their related digital control systems. Mr. Nagai is a member of Japan Society of the Power Electronics and IEEE.



**Shinji Sato** graduated from Niigata East Technical High School College in March 1984. He joined as a research member in R&D of TOSHIBA and resigned in January 1997. He joined SANKEN Electric Co., Ltd in January 1997. He has received a Ph.D. in Power Electronic Systems Engineering at Yamaguchi University, Yamaguchi, Japan. He is interested in soft switching converter technology, and rectifier technology. Mr. Sato is a member of Japan Society of the Power Electronics and IEEE.



**Takayuki Matsumoto** received his M.Sc.-Eng from Nagoya Institute of Technology in 2004 and joined as a research member in R&D of SANKEN Electric Co., Ltd. He is interested in soft switching inverter systems, photovoltaic power generation systems and active filter systems. Mr. Matsumoto is a member of Japan Society of the Power Electronics.