

Anisotropic Behavior of Decomposed Granite Soils

화강풍화토의 비등방성 거동특성

안태봉[†] · 진한규^{*} · 노재호^{**}

Tae-Bong Ahn · Han-Gyu Jin · Jae-Ho Roh

Abstract

화강풍화토의 강도와 변형특성을 조사하기 위하여 불포화배수 삼축압축시험을 실시하였다. 주응력방향과 다짐방향을 0, 45, 90도의 세가지 방향성을 갖도록 하였다. 등방압축시 발생하는 압축변형률은 다짐각도에 따라 크게 영향을 받는다. 이차압축시의 변형거동에 관한 시간의존성은 다짐각도와 관계가 없는 것으로 판단되었다. 다짐각도가 압축강도와 변형에 미치는 영향은 특히 낮은 구속압력시에 크다. 다짐각도가 다르다 하더라도 다일러턴시 비율은 다일러턴시로 인한 강도증가와 상관하여 변화한다. 따라서 다짐풍화토는 초기 비등방성 조직을 갖고 있는 모래와 같이 비등방성 역학적 성질을 갖는다고 할 수 있다.

Keywords : Decomposed granite soil(화강풍화토), Anisotropic property(비등방성), Sedimentation angle(다짐방향)

1. Introduction

Artificial soil structures, such as riverbanks and embankments, including roads and railways, have stress history of compaction with their construction. Anisotropy has not been considered for railroad-bed pressure design yet. However, in reality, anisotropy easily occur due to material property and geometric property. compaction is one of those reasons. In this process, the compacted soil possesses an anisotropic property. Many laboratory works have been conducted to find the compressibility or mechanical properties of compacted material.

For compacted specimens employed in conventional triaxial tests, the direction of the compaction loading corresponded with the direction of the major principle stress. However, the stress condition in a soil structure

caused by additional loading, such as earthquake, should vary by the direction of the major principal stress. Therefore, in order to study the detail stability and deformability of a structure using compacted materials, it is necessary to understand the anisotropic properties for the compacted material. Study of the anisotropic property of compacted materials are limited to clay soils, although it has been widely recognized [1-2]. Conversely, saturated clay and soil has been studied by many researcher [3-4] Therefore, it is necessary to collect substantial data in order to understand the mechanical properties.

A series of unsaturated-drained triaxial compression tests were performed on compacted materials. Decomposed granite soil which was used as this type of material has generally been adopted for construction material. The tests were planned to find not only the degree of anisotropy for the sedimentation angle of the compacted material, but also the influences of the confining stress, degree of saturation and specimen preparation method on the anisotropic properties.

[†] 책임저자 : 정회원, 우송대학교 철도건설환경공학과, 교수
E-mail : tbahn@wsu.ac.kr

TEL : (042)630-9735 FAX : (042)630-9735

^{*} 학생회원, 우송대학교 철도건설환경공학과 대학원, 석사과정

^{**} 정회원, GS건설, 토목사업본부, 철도담당 PM

2. Material Properties and Test Methods

2.1 Basic Characteristics

The physical properties of the sample are shown in Table 1, and the grain size distribution curve of the materials in Fig. 1.

For this sample, contents ratio of quartz feldspar and colored mineral were approximately 23.62 and 15%, respectively.

2.2 Sample Preparation

The decomposed granite soil with optimum moisture content ($w=13\%$) was compacted in a container ($200\text{mm} \times 100\text{mm} \times 200\text{mm}$) by hitting with a 2kg rammer. The density of the compacted materials was controlled by the relative compaction, R , to be 90%. The degree of compaction was defined as the percentage of the density to the maximum dry density obtained from the compaction test. The rectangular sample was frozen at under -20°C followed by cylindrical triaxial compression of the specimens into a 50mm diameter and 100mm height using a core bit machine, as shown in Fig. 2. The sample had three different angles of the axial (major principal) direction to the sedimentation plane (compaction plane), 0, 45 and 90 degrees.

2.3 Test

Unsaturated-drained triaxial compression tests were carried out on the specimens at a constant strain rate of 0.1mm/min. A double cell in the apparatus was equipped to measure the volume change of the specimen. The axial strain was measured using the gap sensor of up to 2.0% during the consolidation and initial part of the shear process.

The specimens were set up under a 20kPa confining pressure, with melting for about 6 hours. After that, confining pressures up to, 30, 60, 120 or 240kPa were applied 1 or 10hours, in order to find the time dependency of the mechanical behaviour of the unsaturated compacted materials.

3. Test results

3.1 Effect of the sedimentation angle on the compression settlement

Fig. 3 shows the relationship between the elapsed compression time and the axial strain for a sample subjected to a 60kPa confining stress. There were two compression processes, One was the primary compression process from the beginning to the end of the confining pressure loading, and the other was the secondary

Table 1. Physical properties of the soil used

Sample	Grain size (mm)	Gs	e_{\max}	e_{\min}	d_{50}	Ignition loss(%)	Uc	Ip	W_{opt}	ρ_{dmax}
Shimonoseki decomposed granite soil	2	2.685	1.116	0.613	0.555	1.83	7.14	N.P	13.24	1.783

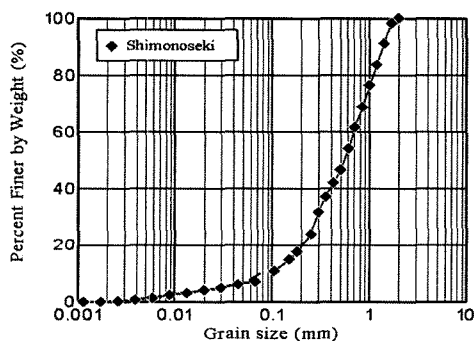

Fig 1. Grain size distribution curve

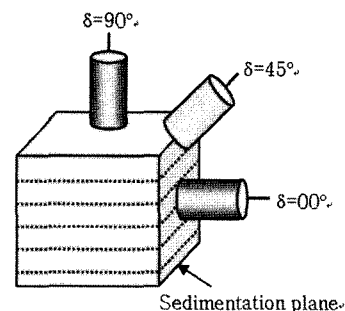

Fig 2. Schematic diagram of the sedimentation angle

compression process after the end of the confining pressure loading. The amounts of axial strain during the primary and secondary compressions were referred to as S_1 and S_2 , respectively, as shown in Fig. 3.

The isotropic compression reaction, S_1 , increased suddenly due to the immediate settlement during the primary compression process, after then S_2 shows only a slight non-linear relationship with the function of the logarithm of time during the secondary compression process.

Fig. 4 shows the relationship between the axial strain and time under the conditions of 60kPa of confining pressure and 10 hours compressive stress. The arrow in the figure represents the moment the load ended. As δ of the specimen decreased from 90° to 0° , the axial strain S_1 increased.

Fig. 5 shows the effect of the confining pressure on the relationship between the axial strain and the duration of

compressive stress for samples subjected to 30, 60, 120, 240kPa confining pressures for specimens with $\delta = 90^\circ$. As the confining stress increased, the amount of axial strain S_1 also increased. The arrows in the figure represent the moment the load ended. Then, the amount of axial strain, S_2 , was approximately the same for all confining stresses. The behaviour of deformation during the secondary compression process was verified as not having any dependency on the confining stress.

Fig. 6 demonstrates the relationship between the duration and axial strain in the secondary compression process from Fig. 4. From Fig. 6, with longer duration, the rate of decrease became gentle. In addition, the reacting of deformation during the secondary compression process was dependent of δ . The influence of the sedimentation angle did not appear in the secondary compression process. S_2 was considered to be related to the particle rearrangement and decrease suction factors due to the compression.

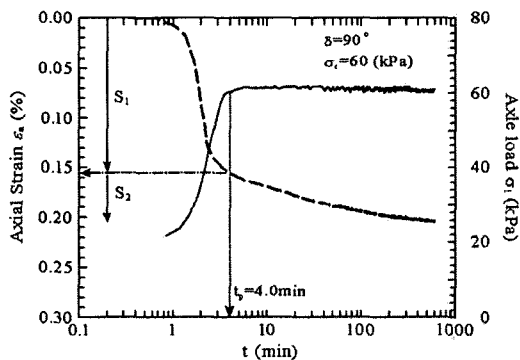

Fig 3. Relationship between axial strain, axial load and compression time

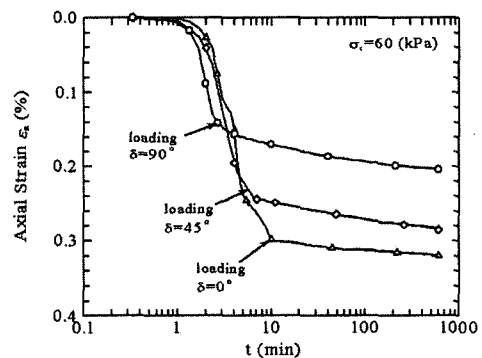

Fig 4. Relationship between axial strain and compression

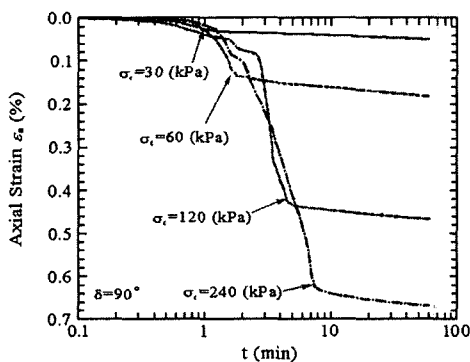

Fig 5. Relation between axial strain and compression

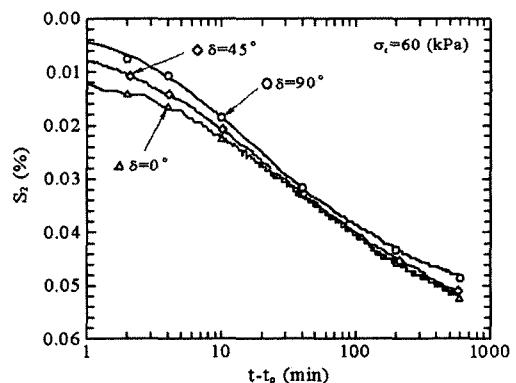

Fig 6. Relationship between S_2 and $t-t_p$

3.2 Effect of the sedimentation angle on the strength

In order to investigate the shear property of the compacted specimen with 90, 45 and 0 degree sedimentation angles, drained triaxial compression tests were performed. The deviator stress-axial strain and axial-volumetric strains diagrams for the specimen compressed at 120kPa are shown in Fig. 7. The deviator stress was defined by $q=(\sigma_1 - \sigma_3)$.

In this result for the stress-strain relation, the stress reaction showed a clear maximum stress points, which slowly decreased. As the value of δ increased from 0° to 90° , the maximum value of the stress q_{max} also increased, but the axial strain at q_{max} decreased. In addition, the dilatancy rate at the point of failure increased with increasing δ . Fig. 8 shows the change in the deviator stress obtained for strains up to 0.05% for the specimens the same relation as shown in Fig. 7.

If the strain behavior changed from a linear to a non-linear deformation, the initial tangent modulus (E_{tan}) is not the same as the Secant Young's modulus (E_{sec}). In this paper, it was assumed that the axial strain at $E_{tan}=E_{sec}$ was the critical condition of elastic deformation. Generally, the E_{tan} of soil materials of no cementation are the same as E_{sec} at approximately less than 0.001% axial strain [5]. The Secant Young's modulus (E_{sec}) was then investigated for the condition of less than 0.001% axial strain on the

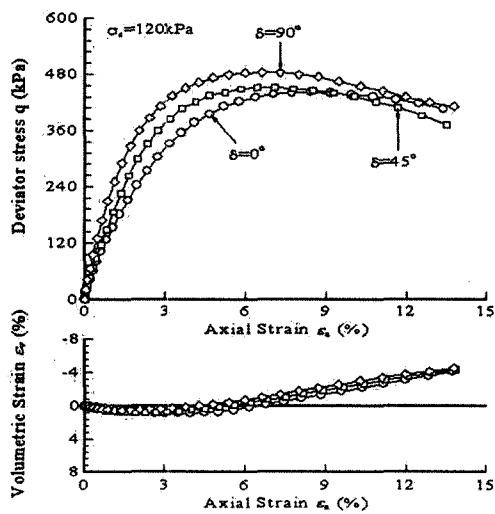

Fig 7. Stress-Strain relations with variations of sedimentation angle

compacted material.

Fig. 9 shows the relation between the Secant Young's modulus at 0.001% strain and the mean principal stress, p . The modulus increased to a linear relationship, having a slope of 0.519. Comparing the dependency for general soil (soil materials of no cementation), which is known as 0.5 [6-7], the compacted material was found to have almost same dependency.

In addition, the δ had no influence on the dependency of Secant Young's modulus on p . Tatsuoka [4] and Kohata [8] reported similar results for sand. Therefore, the compacted soil also showed a small strain level (elastic deformation), which was not enough to affect the sedimentation angle. The Secant Young's modulus would only be related to the rigidity of a particle.

Fig. 10 shows the relationship between the secant shear resistance angle at peak shear stress (ϕ_{peak}) and δ .

The angle ϕ was calculated by the following equation.

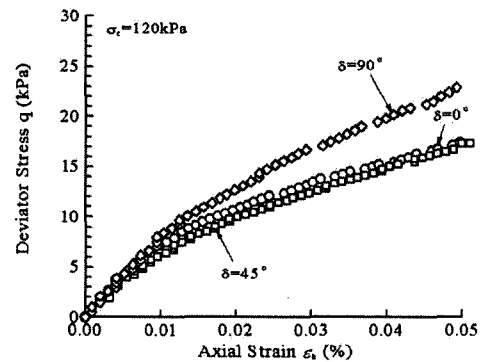

Fig 8. Stress-Strain relations ($\epsilon_a=0.05\%$)

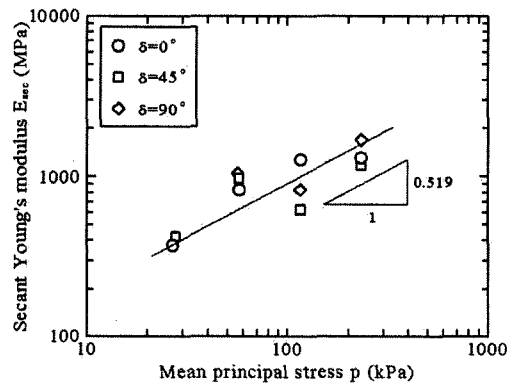

Fig 9. Relationship between Secant Young's modulus and mean principal stress

$$\phi = \sin^{-1} \frac{(\sigma_1 - \sigma_3)}{(\sigma_1 + \sigma_3)} \quad (1)$$

where σ_1 is the major principal stress and σ_3 is the minor principal stress.

As the value of δ increased from 0° to 90° the angle (ϕ_{peak}) also increased. The angle (ϕ_{peak}) of the 10 hours compressed specimens appeared to be approximately 2 degrees lower than that of the 1 hour compressed specimens. The degrees of saturation of the 1 hour and 10-hour compressed specimens were approximately 60% and 65%, respectively. Thus, the decrease in the strength over 10 hours would be related to the increase in saturation of the specimen, which also caused the decrease in suction.

In Fig. 10, the strength data on Ube decomposed granite soils prepared by the air pluviation method has been indicated [9]. The angle (ϕ_{peak}) of Ube appeared to be approximately 10 to 15 degrees lower than that of Shimonoseki. On the basis of this comparison, the influences of the sedimentation angle appears as similar, irrespective of the sample preparation method.

Fig. 11 represents the effect of the sedimentation angle shown by Tatsuoka et al. [4], who proposed the normalization of the shear resistance angle to that of the shear resistance angle 90° δ , $\phi(\delta)/\phi(\delta=90^\circ)$. The data for Toyoura sand, obtained by Oda et al. [3] and Tatsuoka et al. [4], are also shown in this figure. All specimens shown in Fig. 11 appear to have similar tendencies, in that the value of $\phi(\delta)/\phi(\delta=90^\circ)$ increased with increasing δ ,

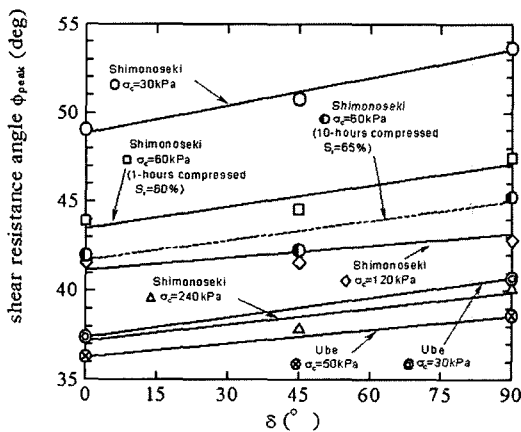

Fig. 10. Relationship between shear resistance angles at peak shear and δ

although factors relating to the specimens, such as the initial density, the confining stress, the condition of sedimentation and preparation method, were different.

Fig. 12 shows the relationship between the secant shear resistance angles at peak shear stress (ϕ_{peak}) and the mean principal stress, p . As the mean principal stress increased, ϕ_{peak} decreased steeply. The slope became steeper as δ became large. The effect of the sedimentation angle on the strength of deformation was clear with low mean principal stress. In the case of Ube, the tendency for a steep slope was shown to be very gentle with increases in the mean principal stress, p , compare with the data of Shimonoseki.

It was considered that the initial fabric arrangement would remain nearly constant in low confining stress. As the confining stress increased, the particles were rearranged by particle breakage, such that the effect of the sedimentation angle disappeared under high confining stress.

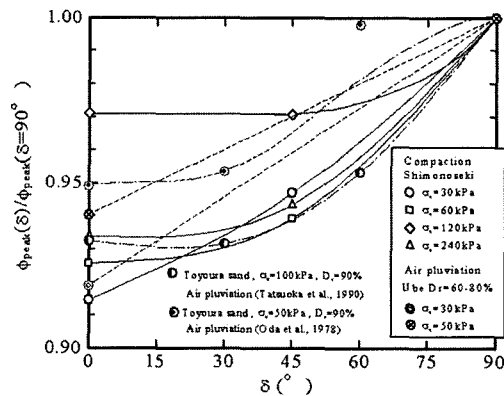

Fig. 11. Relationship between $\phi(\delta)/\phi(\delta=90^\circ)$ and δ

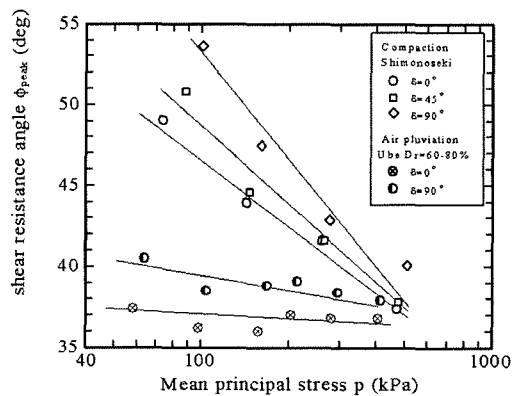

Fig. 12. Relationship between shear resistance angles at peak shear and mean principal stress

3.3 Effect of the sedimentation angle on the dilatancy

In order to show the effect of the sedimentation angle on the dilatancy, the ratio of the volumetric strain increment to the deviator strain at peak stress conditions, $(-d\varepsilon_v/d\gamma)_{peak}$, was examined. Fig. 13 shows the ratio of $(-d\varepsilon_v/d\gamma)_{peak}$ for an angle of sedimentation $(-d\varepsilon_v/d\gamma)_{peak}$ for a δ of 90° . The ratio $(-d\varepsilon_v/d\gamma)_{peak}/((-d\varepsilon_v/d\gamma)_{peak}$ at $\delta = 90^\circ)$ was plotted against of δ . So, when δ was equal to 90° the ratio became 1. As the confining stress increased, the ratio, $(-d\varepsilon_v/d\gamma)_{peak}/((-d\varepsilon_v/d\gamma)_{peak}$ at $\delta = 90^\circ)$, decreased. The $(-d\varepsilon_v/d\gamma)_{peak}/((-d\varepsilon_v/d\gamma)_{peak}$ at $\delta = 90^\circ)$ with a confining stress of 30kPa was 0.58. As the confining stress increased, the value of $(-d\varepsilon_v/d\gamma)_{peak}/((-d\varepsilon_v/d\gamma)_{peak}$ at $\delta = 90^\circ)$ was approximately 1.0. The compacted decomposed granite soils had lower values of $(-d\varepsilon_v/d\gamma)_{peak}$ at $\delta = 0^\circ)/((-d\varepsilon_v/d\gamma)_{peak}$ at $\delta = 90^\circ)$ than the data for the air pluviated decomposed granite and Toyoura sand.

Fig. 14 shows the relationship between $(\phi_{peak}-\phi_{cv})/(\phi_{peak}-\phi_{cv}$ at $\delta = 90^\circ)$ and δ , where ϕ_{cv} is the shear resistance angle at the constant volume condition and $\phi_{peak}-\phi_{cv}$ is considered the increment part of the strength due to dilatancy of the specimen. The value of ϕ_{cv} was defined as the minimum value in all tests of the mobilized angle where the deviator strain reached 14%. As the confining stress increased and the value of δ decreased, the value of $\phi_{peak}-\phi_{cv}$ became smaller. Moreover, the tendency for the effect of the sedimentation angle at strength, as shown in Fig. 14, agreed to it is being on the dilatancy, as shown in Fig. 13.

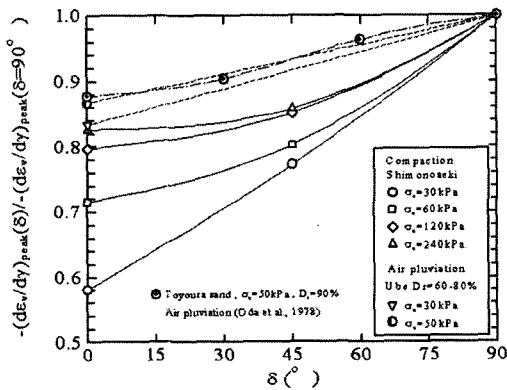

Fig. 13. $-(d\varepsilon_v/d\gamma)_{peak}(\delta) / -(d\varepsilon_v/d\gamma)_{peak}(\delta=90^\circ)$ and δ Relations

Fig. 15 shows the relationship between the increment of strength due to dilatancy, $\phi_{peak}-\phi_{cv}$, and the dilatancy rate, $(-d\varepsilon_v/d\gamma)_{peak}$ at failure. As $(-d\varepsilon_v/d\gamma)_{peak}$ increased, $\phi_{peak}-\phi_{cv}$, also increased. The same tendency was obtained for all specimen used in this paper. It was also recognized that although the sedimentation angle and preparation methods were different, the increment of strength was related to the dilatancy rate at failure due to dilatancy. Therefore, it can be concluded that the difference between the peak strength ϕ_{peak} and the residual strength ϕ_{cv} was dominated by the dilatancy for compacted specimens, as with sand.

3.4 Discussion on initial fabric of compacted material

Lambe [4] started a way of thinking about the structure of compacted soil, and although many researchers have tried to examine the fabric (structure) of compacted soil

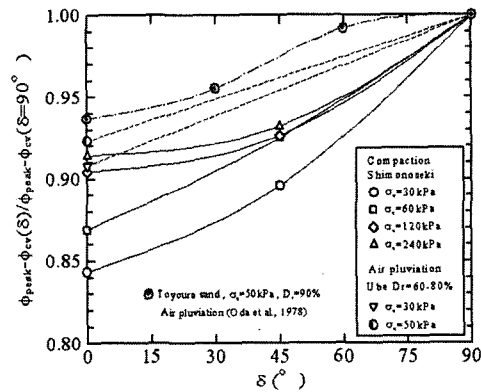

Fig. 14. $\phi_{peak}-\phi_{cv}(\delta) / \phi_{peak}-\phi_{cv}(\delta=90^\circ)$ and δ Relations

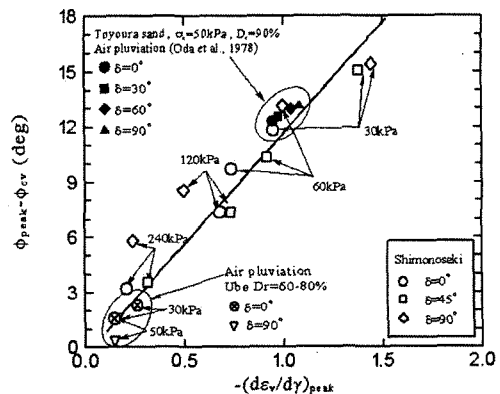

Fig. 15. Relationship between $(\phi_{peak}-\phi_{cv})$ and $-(d\varepsilon_v/d\gamma)_{peak}$

[10] no consensus has been completely established. Attempts to observe the fabric arrangement of the specimens used in this paper using microscopy were made, but the fabric anisotropy could not be confirmed. Generally, the fabric anisotropy of saturated sand due to air-pluviation sedimentation has been known to develop in the direction of sedimentation.

Onitsuka and Hayashi [11] pointed out that the strength anisotropy of compacted sandy soils was caused by the direction of fabric arrangement, as the direction of the fabric arrangement was willing to orientate perpendicularly to the compaction direction.

From the result of the unsaturated-drained triaxial compression tests on the compacted decomposed granite soils in this paper, it can be concluded that the compacted specimen had anisotropic mechanical properties the same as those initially found with sand.

4. Conclusions

A series of unsaturated-drained triaxial compression tests were performed on compacted materials. The tests were planned to find the effect of, not only the degree of anisotropy for sedimentation angle of compacted material, but also the influence of confining stress, degree of saturation and specimen preparation method on the anisotropic properties. The following conclusions can be drawn from this study:

- (1) The compression strains of specimens were strongly influenced by the sedimentation angle.
- (2) The Secant Young's modulus showed the same behaviour for all specimens, even with different δ .
- (3) The effects of the sedimentation angle on the triaxial compression strength and deformation were clear of a low confining stress.

- (4) Although the sedimentation angle and preparation methods were different, the dilatancy rate was related to the increments in strength due to dilatancy.
- (5) The compacted specimen can be considered to have anisotropic mechanical properties, the same as the initial fabric anisotropy of sand.

References

1. Livneh, M., Komornik, A. (1967). Anisotropic strength of compacted clay, Proc., 3rd ASIAN Reg. Conf. On SMFE, Vol.1: 298304.
2. Onitsuka, K., Hayashi, S., (1979). Studies on compression and strength Anisotropy of compacted soils, in Japanese. JSCE. Vol.19, No.3, Sept: 113123.
3. Oda, M., Koishikawa, I., and Higuchi, T. (1978). Experimental study of anisotropic shear strength of sand by plane strain test, Soils and Foundation, Vol.18, No.1: 2538.
4. Tatsuoka, F., Nakamura, S., Huang, C. and Tani, K. (1990). Strength snisotropy and shear band direction, Soils and Foundation, Vol.30, No.1: 3554.
5. Tatsuoka, F., Shibuya, S. (1992). Deformation characteristics of soils and rocks from field and laboratory tests, Keynote Lecture, Proc. of 9th Asian Regional Conf. on SMFE, Vol.2: 101170.
6. Hardin, B.O. and Richart, F. E.Jr. (1963). Elastic wave velocities in granular soils, Journal of SMF Div., ASCE, Vol. 89, No. SM1: 3365.
7. Hardin, B.O. and Black, W. L. (1969). Vibration modulus of normally consolidated clay, Journal of the SMF Div., Proc. ASCE, Vol.95, No. SM6: 15311537.
8. Kohata, (1995). Inherent and induced anisotropy of sedimentary softrock, Proc. Of 10ARC: 3336.
9. Nakata, Y., Hyodo, M. and Murata, H (1998). Single particle crushing and mechanical behaviour of decomposed granite soil, Proceedings of the international symposium on problematic soils., IS-TOHOKU'98. SENDAI, JAPA:497483.
10. Lambe, T. W. (1958). The structure of compacted clay, Proc., ASCE., Vol 84, SM2: 16551165535.
11. Seed, H.B., Mitchell, J.K. and Chan, C.K. (1960). The strength of compacted cohesive soils, ASCE., Research Conf. on the Shear Strength of Cohesive