

Inverse Analysis of Ultrasonic Signals of Ceramics Based on Ultrasonic Self-Compensating Technique

Joon-Hyun Lee*

*School of Mechanical Engineering Pusan National University,
30 Changjeon-Dong, Kumjeong-Ku, Pusan 609-735, Korea*

Ansheng Cheng

*Center for Quality Engineering and Failure Prevention,
Northwestern University Evanston, IL 60201-3020, U.S.A*

An ultrasonic self-calibrating technique for the characterization of a ceramic which was fabricated by change pressing time during the HIP process has been applied by using the ratio of the reflection and transmission coefficients of normal incidence longitudinal waves. The ratio is self-compensated, in that it is independent of the characteristics for transmission and reception of ultrasound by the transducer and the condition of the couplant. The insensitive direction in parameter space is defined as the direction in which the variation of the ratio to changes of two parameters vanishes. For inverse problem the distribution of minima in an error surface is investigated.

Key Words : Ultrasonic self-Compensating Technique, Inverse Problem, Ceramics, HIP Process, The Ratio Function

1. Introduction

Structural ceramics have been used as components in hostile environments because of their good thermo-mechanical and chemical properties. For fabrication of high quality ceramic components, many processing techniques such as hot pressing, hot isostatic pressing, and sinter forging have been proposed (Arons and Kupperman, 1982; Li et al., 1987). Among them, hot isostatic pressing (HIP) has been widely used in industrial applications, essentially to produce high quality components, through complete densification of ceramic powers. There are a number of situations of technological importance in which one wishes

to carry out an ultrasonic NDE of the acoustic properties of thin plate. A few examples are: adhesively-bonded joints; free standing thin foils of metals and ceramics; near-surface delamination in composites materials (Yang et al., 2004; Kim et al., 2004). Applications using a self-calibrating or self-compensating technique for the measurement of surface waves reflected or transmitted by a surface breaking crack have been reported elsewhere (Achenbach et al., 1992; Cheng and Achenbach, 1996) for the use of contact transducers. The major advantage using the technique is that the evaluation is independent of the characteristics for transmission and reception of ultrasound by the transducers, the attenuation in the couplant and the surface condition of the specimen. In order to effectively determine the parameters of ceramic, the sensitivity of the ratio of transmission and reflection coefficients of the specimen to variation of the parameters needs to be studied. The higher this sensitivity, the lower the error in the inverse problem. If the sensitivity is small, even a slight error in the experimental

* Corresponding Author,

E-mail : johlee@pusan.ac.kr

TEL : +82-51-510-2430; FAX : +82-51-512-9835

School of Mechanical Engineering Pusan National University, 30 Changjeon-Dong, Kumjeong-Ku, Pusan 609-735, Korea. (Manuscript Received March 31, 2005;

Revised December 15, 2005)

measurements may result in a large error in the deduced parameters.

For the inverse problem the minimum of an error in parameter space is determined. It is shown that when the parameters to be determined contain a strongly coupled pair, for example, the thickness and phase velocity of the specimen, then the true minimum is located in a valley, in a direction in which the sensitivity of the relevant ratio to parameter changes vanishes. The determination of the unknown parameters containing a strongly coupled pair may therefore be difficult. The research procedure can then, however, be made more effective by use of a constraint condition.

Two constraint conditions are used for the determination of unknown parameters which contain a strongly coupled pair. The introduction of these constraint conditions reduces the research for the true minimum (Park and Lee, 2003) to the insensitive direction only, and the global minimum is then obtained with greater ease and accuracy. The search for a true minimum in error surface under a constraint condition converges if a single strongly coupled pair is to be determined. For a case in which more than one strongly coupled pair must be determined, constraint conditions can still be used as long as the insensitive directions in the error surface do not coincide.

In this study, the characterization of ceramic which was fabricated by changing process parameter during the HIP process has been extensively investigated. A self-calibrating ratio of the transmission and reflection coefficients is formulated based on the expressions for the transmission and reflection coefficients. The inverse problem, including the sensitivity analysis (Jeong and Yoo, 2003), the error surface simulation and the inverse algorithm formulation are discussed.

2. Materials and Experimental Details

2.1 Materials and experimental details

The setup for the experiment is shown in Fig. 1. A matched pair of Panametrics broadband piezoelectric transducers with center frequency 5

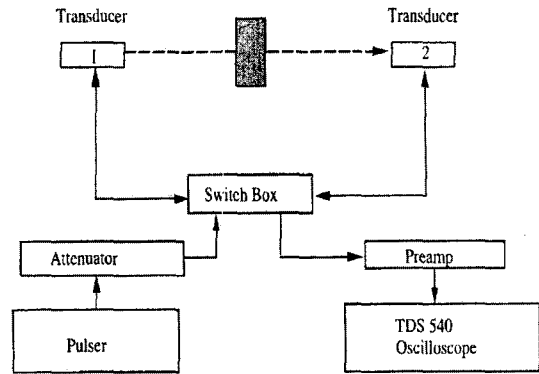

Fig. 1 Schematic of the experimental

Table 1 Parameters of the samples

| | h (mm) | c (km/sec) | ρ (g/cm ²) |
|----------|----------|--------------|-----------------------------|
| Sample A | 15.203 | 10.740 | 3.897 |
| Sample B | 15.194 | 10.671 | 3.885 |
| Sample C | 15.201 | 10.194 | 3.732 |

MHz was used as transmitter and receiver. For the determination of the unknown parameters of a plate using transmitted signal, the alignment of the two transducers is important. In this experiment, a specially designed fixture was used to keep the two transducers perfectly aligned. The position of the line between the transducer pair can be kept perpendicular to the specimen by adjusting a rotational and tilt stage. Three samples of Al_2O_3 ceramics made under 50 MPa pressure at 1500°C temperature with 100, 50 and 5 minutes holding duration are available to be tested. The parameters of the samples were measured and listed in Table 1.

To acquire the data, a short duration pulse signal, generated by a Panametrics Ultrasonic Analyzer mode 5600 and attenuated 10 dB by an attenuator, is applied via a switch box to the transmitter. The transmitted signal from the specimen is received by the receiver, and amplified 34 dB by a Panametrics preamplifier. The signal is then sent to a Tektronix TDS 540 oscilloscope where it is digitized into 5000 points with a sampling interval of 20 ns. The digitized signal is then acquired by a personal computer through a GPIB interface. The signals transmitted through the sample A, B and C are shown in Fig. 2.

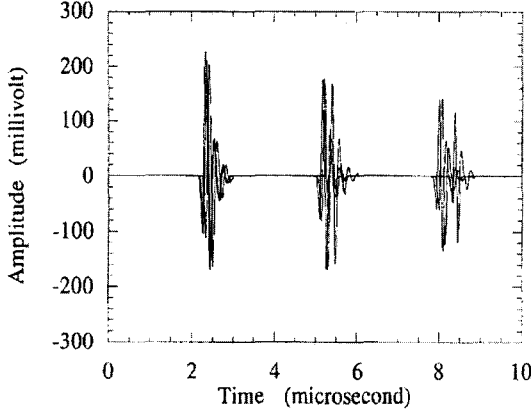

Fig. 2 Comparison of waveforms for three samples

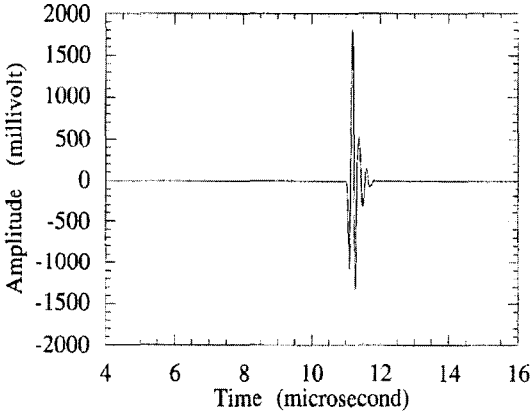

Fig. 3 Water path signal

The water path signal for transmission is needed for the reconstruction of the signal transmitted through the sample. The water path signal was obtained by taking the signal when there is no test sample in between the transducers, which is shown in Fig. 3.

3. Results and Discussion

3.1 Reconstruction of the transmitted signal

For the configuration shown in Fig. 1, the time domain signal transmitted through a sample has been formulated as

$$V_{12}(x, t) = \frac{1}{2\pi} \int_{-\infty}^{+\infty} V_{12}^W T_{12} e^{ik_0 h} e^{i\omega h} d\omega \quad (1)$$

where $x = x(x_1, x_2, x_3, \dots, x_{n-1}, x_n)$ is a vector in the parameter space of the sample, T_{12} is the

transmission coefficient of the sample, h is the thickness of the sample and k_0 is the wave number in the water, ω is the frequency and V_{12}^W is the signal transmitted through the water paths.

The transmission coefficients of a plate have been derived as

$$T_1(x, \omega) = \frac{2iz_0\omega(M_{11}M_{22} - M_{12}M_{21})}{(M_{21} - z_0^2\omega^2 M_{12}) + iz_0\omega(M_{11} + L_{22})} \quad (2)$$

where z_0 is the acoustic impedance in water and M_{ij} are the components of the stress-displacement transfer matrix of the plate which may be derived as

$$M = \begin{bmatrix} \cos(kh) & \frac{1}{z\omega} \sin(kh) \\ -z\omega \sin(kh) & \cos(kh) \end{bmatrix} \quad (3)$$

where z , and k are acoustical impedance and the wave number of the plate.

For a linear visco-elastic material, attenuation occurring within the sample can be incorporated into these equations by replacing with k with $(k' - k'')$, where k'' is the attenuation in the sample. It is customary to write $k'' = \alpha$. For most engineering material the attenuation, α is a linear function of frequency over a few frequency decades. A dimensionless attenuation, $\beta = \alpha\lambda$ has been introduced, where β is the decay of amplitude over one wavelength and a material constant.

3.2 Inverse algorithm and determined parameters

An expression for the error between the reconstructed and measured time domain signals in formed in the least square sense as

$$E(x) = \frac{1}{n} \sum_{i=1}^n (V_e(t_i) - V_c(t_i, x))^2 \quad (4)$$

where V_e denotes the measured signal, V_c denotes the reconstructed signal and n denotes the number of the signal digitized. The Downhill Simplex method for multi-dimensional minimization in Ref.(Press et al., 1994) was applied in search of the minimum in an error surface. For this inverse problem, the thickness, the phase velocity and the attenuation coefficient are taken as variables and the density is taken from the measured value.

Since the attenuation coefficient does not change the time span of waveform, the inverse procedure can be simplified by taking two steps to determine the attenuation coefficient of the samples. First, the thickness and the phase velocity are searched in the error surface while the attenuation coefficient is set to be zero, such that the time span of the measured and reconstructed waveforms are perfectly matched. The attenuation coefficient can then be searched to make the amplitudes of the waveform reconstructed and measured matches as perfected as possible. An inverse process to determine the attenuation coefficient is also in a more controllable way by using this two step approach because each inverse process can be visually presented.

Figure 4 is the error surface and its topography for the sample A where the thickness and phase velocity are varied 1% from their true values. The minimum, the true values of the thickness and the phase velocity, can be located. The comparison of the reconstructed wave in the first stage (the thickness and phase velocity are searched values, and the attenuation coefficient is set to be zero) and the measured wave is shown in Fig. 5. The error surface can then be recalculated with the determined thickness and the phase velocity as the fixed values and the attenuation coefficient as a variable. The error surface for the attenuation is shown in Fig. 6. Similarly, the unique attenuation value can be located. The finally reconstructed wave for sample A is compared and shown in

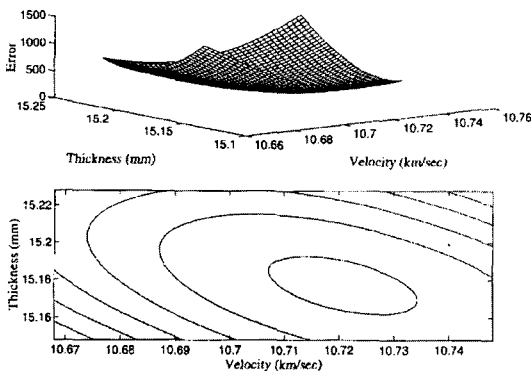

Fig. 4 Error surface for experimental results, where the parameters are the thickness and phase velocity

Fig. 7. By taking the same procedure, the parameters for the sample B and C are also determined. All determined parameters and their relative errors for all three samples are listed in Table 2, where the dimensionless attenuation coefficients are recalculated and presented. The comparison of the measured and reconstructed waveforms for the samples B is shown in Fig. 8.

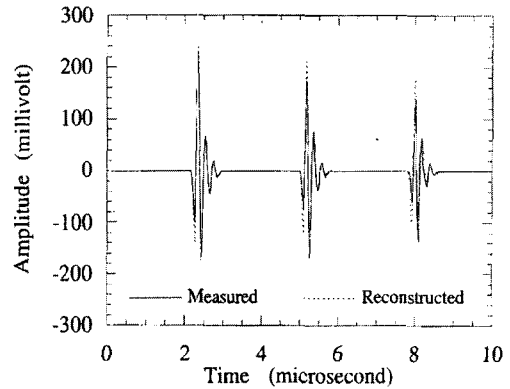

Fig. 5 Comparison between measured and reconstructed waveforms (sample A no attenuation)

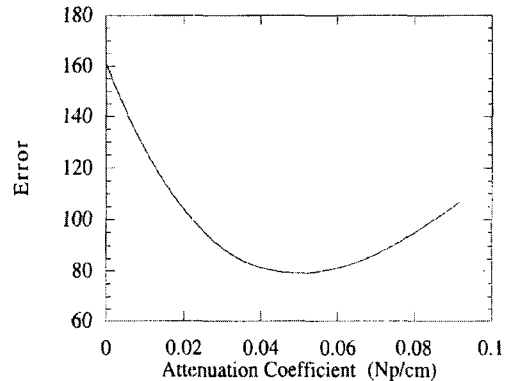

Fig. 6 Error in the insensitive direction and the error curve obtained using the time of flight

Table 2 Determined parameters for three samples

| | h (mm) (Error %) | c (km/sec) (Error %) | β (Np) |
|----------|-----------------------|---------------------------|--------------|
| Sample A | 15.203 (0.12) | 10.740 (0.196) | 3.897 |
| Sample B | 15.194 (0.09) | 10.671 (0.412) | 3.885 |
| Sample C | 15.201 (0.13) | 10.194 (0.157) | 3.732 |

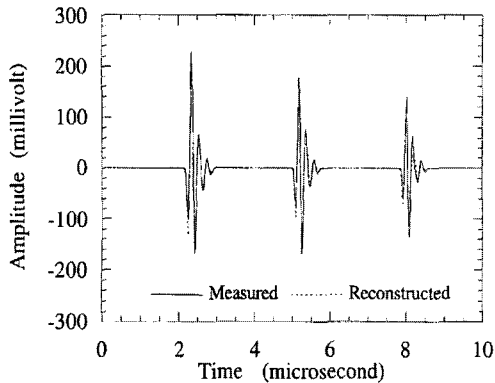

Fig. 7 Comparison between measured and reconstructed waveforms (sample A)

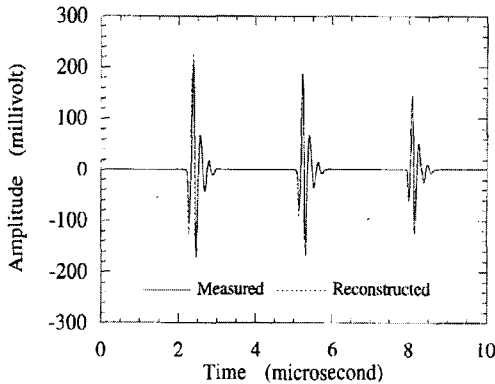

Fig. 8 Comparison between measured and reconstructed waveforms (sample B)

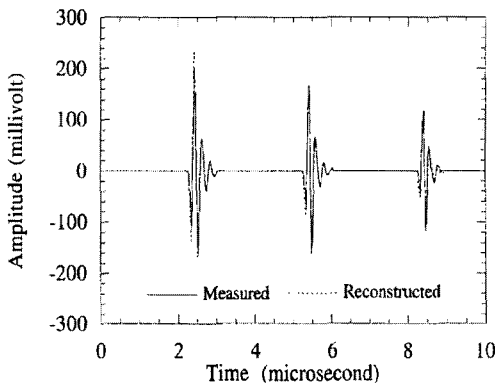

Fig. 9 Comparison between measured and reconstructed waveforms (sample C)

4. Conclusions

A self-calibrating technique for the characteri-

zation of ceramic has been established by using the ratio of the reflection and transmission coefficients. The ratio function is self-compensated, in that it is independent of the characteristics for transmission and reception of ultrasound by the transducers and the condition of the couplant. The sensitivity of the ratio function to variation of the parameters has been studied. The introduction of a constraint equation reduces the search for the true minimum to the insensitive direction only. The global minimum is then obtained with greater ease and accuracy. The results show that the method can be effectively applied for the characterization of a ceramic material.

Acknowledgment

This work was supported by the Ministry of Science & Technology through Basic Atomic Energy Research Institute (BAERI) program.

References

- Achenbach, J. D., Komsky, I. N., Lee, Y. C. and Angle, Y. C., 1992, "Self-Calibrating Ultrasonic Techniques for Crack Depth Measurement," *J. Nondestructive Evaluation*, Vol. 11, pp. 103~108.
- Arons, R. M. and Kupperman, D. S., 1982, "Use of Sound-Velocity Measurements to Evaluate the Effect for hot Isostatic Pressing on the Porosity of Ceramic Solids," *Materials Evaluation*, Vol. 40, pp. 1076~1089.
- Cheng, A. and Achenbach, J. D., 1996, "Depth Determination of Surface-Breaking Cracks in Concrete Slabs using a Self-Compensating Ultrasonic Technique," *Review of Progress in Quantitative Nondestructive Evaluation*, Plum Press, Vol. 15B, pp. 1763~1770.
- Jeong, W. B. and Yoo, W. S., 2003, "Sensitivity Analysis of Anti-resonance Frequency for Vibration Test Control of a Fixture," *KSME International Journal*, Vol. 17, No. 11, pp. 1732~1738.
- Kim, C. W., Song, S. H. and Oh, D. J., 2004, "Development of the Delamination Evaluation Parameters — The Delamination Aspect Ratio and the Delamination Shape Factors," *KSME*

International Journal, Vol. 18, No. 11, pp. 1932~1940.

Li, W. B., Ashby, M. F. and Easterling, K. E., 1987, On Densification and Shape Change During hot Isostatic Pressing, *Acta Metal.* Vol. 35, No. 12, pp. 2831~2842.

Park, M. G. and Lee, M.C., 2003, "A New Technique to Escape Local Minimum in Artificial Potential Field Based Path Planning," *KSME International Journal*, Vol. 17, No. 12,

pp. 1876~1885.

Press, W. H., Teukolsky, S. A., Vetterling, W. T. and Flannery, B. P., 1994, "Numerical Recipes, Second Edition," *Cambridge University Press*, pp. 399~401.

Yang, J. H., Lee, K. Y., Lee, T. S. and Zhao, S. X., 2004, "Fracture Analysis of Electronic IC Package in Reflow Soldering Process," *KSME International Journal*, Vol. 18, No. 3, pp. 357~369.