

See-saw Type RF MEMS Switch with Narrow Gap Vertical Comb

Sungchan Kang, Sungsoo Moon, Hyeon Cheol Kim, and Kukjin Chun

Abstract—This paper presents the see-saw type RF MEMS switch based on a single crystalline silicon structure with narrow gap vertical comb. Low actuation voltage and high isolation are key features to be solved in electrostatic RF MEMS switch design. Since these parameters in conventional parallel plate RF MEMS switch designs are in trade-off relationship, both requirements cannot be met simultaneously. In the vertical comb design, however, the actuation voltage is independent of the vertical separation distance between the contact electrodes. Therefore, the large separation gap between contact electrodes is implemented to achieve high isolation. We have designed and fabricated RF MEMS switch which has 46dB isolation at 5GHz, 0.9dB insertion loss at 5GHz and 40V actuation voltage.

Index Terms—RF MEMS Switch, vertical comb, low actuation voltage, high isolation

I. INTRODUCTION

RF MEMS switches have been developed by many universities and companies in the last decade. The major research effort has been devoted to enhancing the MEMS switches' RF performance from dc to 100 GHz compared to p-i-n diodes or FET transistor. [1] But these studies have only limited their focus on the RF performance of MEMS switches and have provided little information about other important factors of RF MEMS switches such as actuation voltage. [2] So we have developed the switch that has good RF performance and

low actuation voltage simultaneously.[3] Reducing the actuation voltage of RF MEMS switches enhances their performance significantly and broadens the range of their applications including portable devices which require low actuation voltage. The proposed RF MEMS switches are developed for front-end module of 802.11a WLAN system.

The air gap between contact metals determines isolation property and actuation voltage in conventional parallel plate switches. These parameters are in trade-off relationship. [4] In vertical comb design, the actuation voltage is dependent only on the gap between the combs and independent of air gap between the contact electrodes. By fabricating a narrow gap (<1.5 μm) between the combs can be patterned, the low actuation voltage and high isolation can be achieved simultaneously.

II. STRUCTURES

Fig. 1 shows the schematic of the proposed metal-to-metal (Au) contact RF MEMS switch. The proposed switch utilizes electrostatic forces that act between combs. [5] The electrostatic forces are created when a voltage is applied between the combs, causing them to attract. The force between combs is given by

$$F = \frac{1}{2} \frac{\epsilon w}{g} (2N)V^2 \quad (1)$$

where V , N , w , and g are the voltage difference, the number of comb teeth, the width of the teeth, and the gap between combs, respectively. In this design, the switch has the constant force regardless of the air gap between the contact electrodes. Moreover, by decreasing the gap between combs, the switch can be driven at low voltage.

Manuscript received May 12, 2007; revised Aug. 10, 2007
School of Electrical Engineering and Computer Sciences
Seoul National University 301-1053(#038), Kwanak P.O. box 34,
Seoul, 151-742, Korea

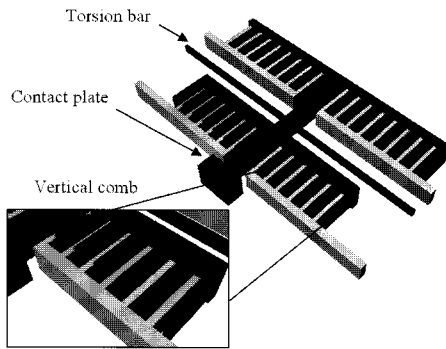

Fig. 1. Schematic of the proposed see-saw type RF MEMS switch.

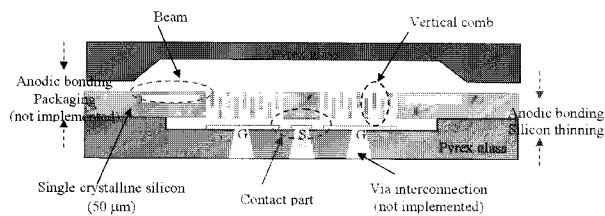

Fig. 2. Cross sectional view of the proposed see-saw type RF MEMS switch.

The actuation of the proposed switch resembles the movement of see-saw. If a voltage is applied between combs on the left side of the torsion bar, the left side of torsion bar moves downward and the right side moves upward. Therefore, the signal line is turned on by the actuation of the contact part. If a voltage is applied between combs on the right side of the torsion bar, the left side of torsion bar moves upward and the right side moves downward. So, the signal line is turned off. When the signal line is turned off, self-actuation does not occurred easily because of attract force between combs on right side of the torsion bar

Fig. 2 shows cross sectional view of the proposed RF MEMS switch. It consists of three parts : the bottom substrate, the switch body, and the capping substrate. Bottom substrate includes CPW line and via hole. The switch body comprises interdigitating vertical combs, a torsion bar, and contacts. The structure is made of single crystalline silicon for reliability and productivity [6][7]. Finally, glass cap wafer is for the packaging purpose.

The single crystalline silicon is chosen as the switch body material. The reliability of the switch can be enhanced because single crystalline silicon has not only more excellent material properties than metals but also was less residual stress. The yield strength of Au and Ni, the common materials for MEMS switches, is 0.2 and 1 GPa respectively, while Si is 6.8GPa. Si also has higher Young's modulus of 190GPa than Au and Ni whose Young's modulus is 77.2 and 207 Gpa, respectively.

The design parameters of the proposed switch are as follow. The thickness of the silicon layer is $50\mu\text{m}$ and the upper and the lower comb is $40\mu\text{m}$. Then, the movable structure can actuate $10\mu\text{m}$ in the vertical direction. The actuation voltage of the proposed RF MEMS switch is designed to be 6V for wireless application. The gap between contact metal and signal line is designed to be $5\mu\text{m}$. So, when the signal line is turned off, the gap between contact metal and signal line can be $10\mu\text{m}$. The gap between combs is $1.5\mu\text{m}$ and the number of comb teeth is 60.

III. SIMULATION

ANSYS is used for mechanical simulation and HFSS for electromagnetic simulation. [8] Fig. 3 shows the result of ANSYS modal analysis. Only the switch body part is simulated. At the first resonant mode, the desired vertical actuation is achieved at the resonant frequency of 7.4 KHz. Fig. 4 show the HFSS simulation model and fig. 5 is the electromagnetic simulation data. The isolation is below 42.6dB and the insertion loss is less than 0.1dB at the 5GHz. The simulation results showed very good RF characteristics. Especially, the isolation is very high because the gap between contact metals is larger than other switches.

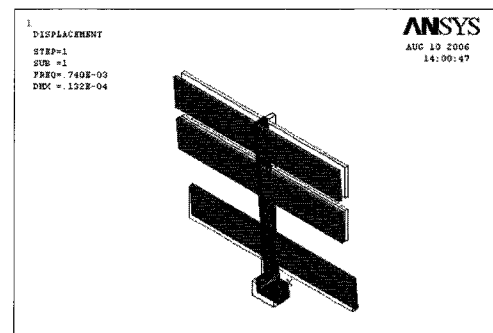

Fig. 3. ANSYS modal analysis.

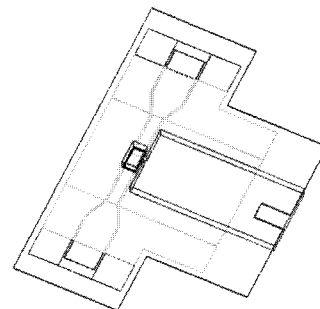

Fig. 4. HFSS simulation model.

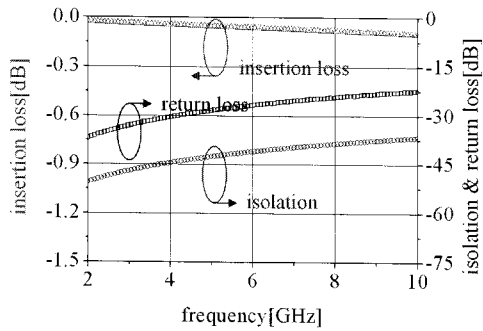

Fig. 5. HFSS simulation results: Isolation and insertion loss.

IV. FABRICATION

The bottom substrate and the switch body are fabricated separately. They are assembled together by anodic bonding. The whole process procedure is illustrated in Fig. 6. The bottom substrate, a glass wafer, is etched as deep as the air gap between contact metal and signal line. In the switch body, trenches with the depth of 50μm and the width of 1μm are made on Si wafer by Si deep etching, and the trench are filled with LPCVD TEOS.

Subsequently, we make contact metal and etch again the movable comb about 10μm deep. After Si deep etching, Si wet etching is done to remove Si which remains on the side. We anodically bond the fabricated glass wafer and Si wafer, and thin Si wafer with CMP to 50μm thickness.

After the bonding step (e), we can align the upper and lower comb pattern using the front side alignment only and this technique significantly reduces the alignment error. In order for combs to be able to interdigitate in the vertical direction, we etch the stationary comb about 10μm deep. For the torsion bar, we etch about 3μm deep, and passivate the side through TEOS deposition. Then, we remove Si which remains on the side through Si wet etching.

When we etch the trench which is 50μm deep and 1μm wide by Si deep etch process, the extra process to reduce the gap is necessary. To form the 0.8μm-wide trench, the opening of 0.4μm is required because there is 0.2μm undercut in Si deep etching.

We can get reduced gaps using TEOS deposition and etching. Fig. 7 shows the cross section of the sub-micron gaps formed by this technique. Fig. 8 is an SEM of the cross section of a 50μm Si-deep- etched trench which has the aspect ratio of 1 :40. We can achieve repeatability and uniformity of the gap reducing technique used in the fabrication process.

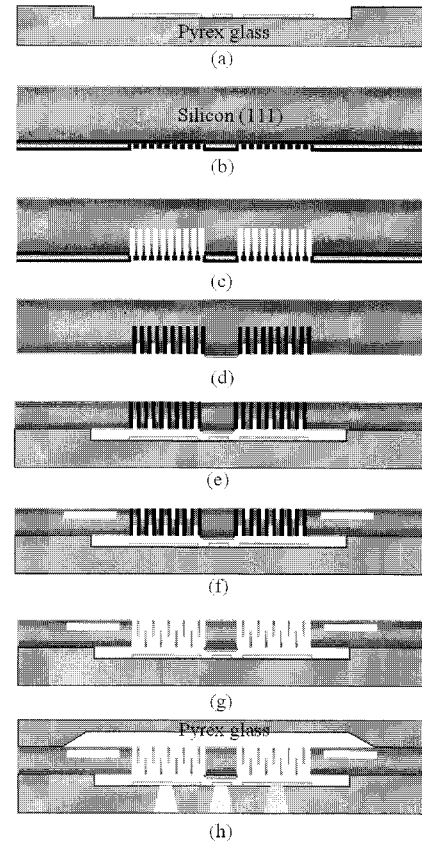
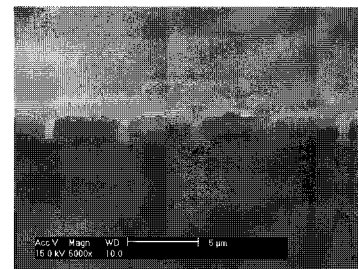
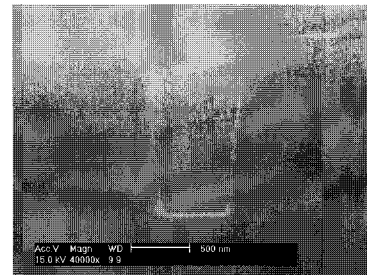

Fig. 6. Fabrication Process: (a) Air-gap formation and CPW patterning on bottom glass wafer, (b) Oxide(deep Si etch mask) patterning using reduced-gap formation, (c) Deep Si etching, (d) Trench filling, contact metal formation and vertical comb patterning, (e) Anodic bonding and silicon wafer thinning, (f) Beam patterning and vertical comb patterning, (g) Release, (h) Packaging.



(a)



(b)

Fig. 7. Sub-micron gap.

Fig. 9 shows the fabricated see-saw type RF MEMS switch. Fig. 10 is an SEM of the completed see-saw type RF MEMS switch, contact part, torsion bar and vertical combs. Fig. 10 (b) illustrates that the the section of contact metal is aligned well on the separate signal lines. Fig. 10 (d) is an SEM of the well-formed interdigitated vertical comb.

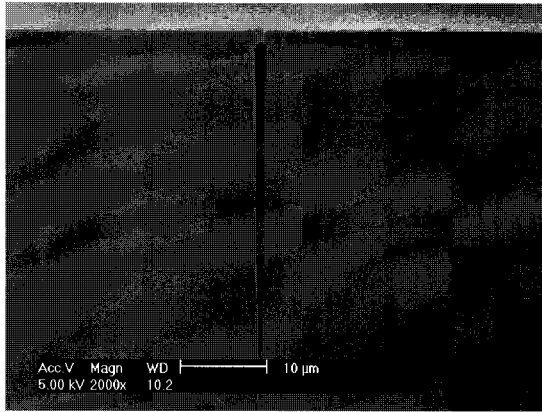

(a)

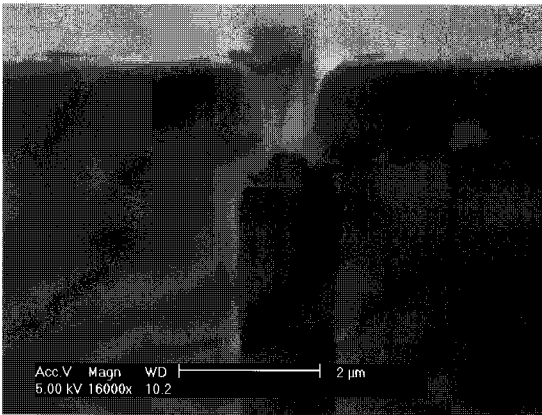

(b)

Fig. 8. After deep Si etching (1 : 40 aspect ratio).

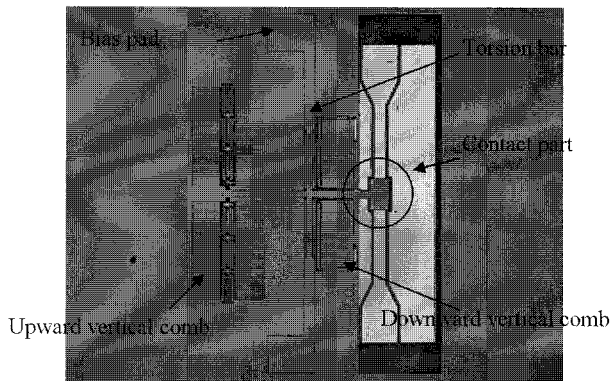
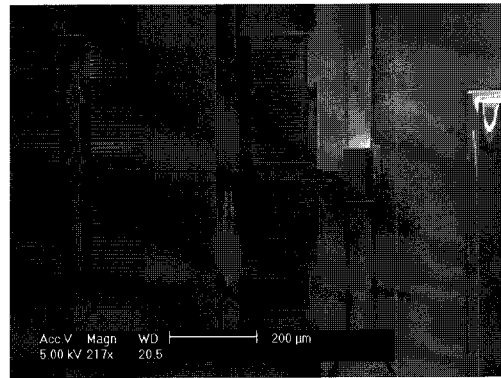
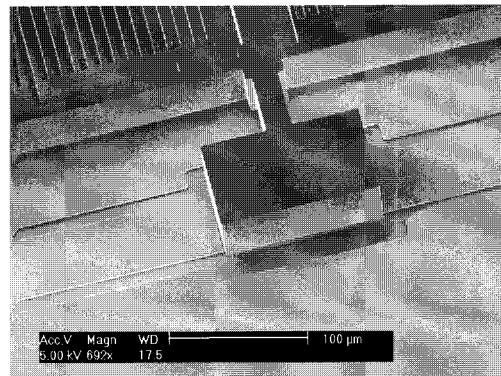

Fig. 9. Fabricated See-saw type RF MEMS switch with vertical comb.



(a)



(b)

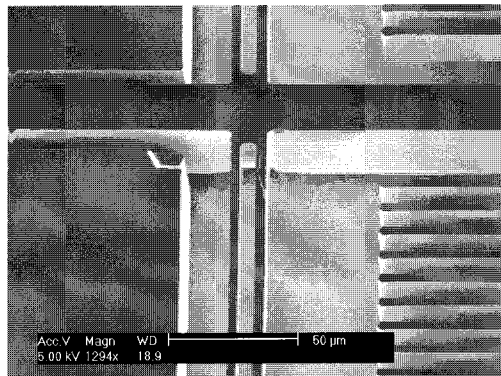

(c)

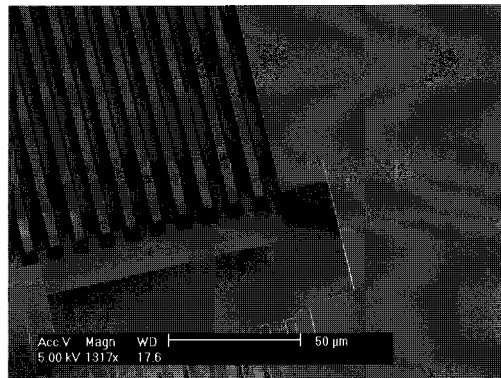

(d)

Fig. 10. Fabrication results: (a) See-saw type RF MEMS switch, (b) Contact part, (c) Torsion bar, (d) Narrow gap vertical comb.

V. MEASUREMENT RESULTS & DISCUSSION

The fabricated switch has 40V actuation voltage, which is higher than design. Therefore, we compared the parameters of the fabricated switch with the designed ones. The gap between contact metals is $5\mu\text{m}$ as designed. However, the gap between combs is $1.2\mu\text{m}$, which is $0.4\mu\text{m}$ larger than the designed value of $0.8\mu\text{m}$. This is due to the fact that undercut formed in Si deep etch process added $0.2\mu\text{m}$ to both sides. Since the electrostatic force between combs is inversely proportional to the gap between combs, the force is reduced by the factor of 1.5. In addition, the thickness of torsion bar is measured to be $10\mu\text{m}$, which is 3.3 times larger than the designed value of $3\mu\text{m}$. Since polar moment of inertia is proportional to the cubic of the torsion bar's thickness, the polar moment of inertia becomes about 33 times larger, which means that 33 times larger drive force is needed. Consequently, the increased gap between combs and thickness of the torsion bar cause 50 times weaker forces to be exerted at the actuation voltage of 6V. Therefore, the actuation voltage higher than 6V should be applied. Because the force is proportional to the square of the voltage, the actuation voltage needs to be 7 times larger. The actuation voltage of 42V is expected, which is almost same as the measured value of 40V. If the switch is fabricated as intended, the actuation voltage is expected to be within 10V.

Fig. 11 shows RF characteristics of the switch. The switch has 46dB isolation at 5GHz and 0.9dB insertion loss at 5GHz. The measured isolation properties agree well with the simulation results. But insertion loss appears to be worse. Deterioration of the contact metal surface due to subsequent processes after the deposition of the metals may result in the increase of contact resistance of the metals, correspondingly making insertion loss larger.

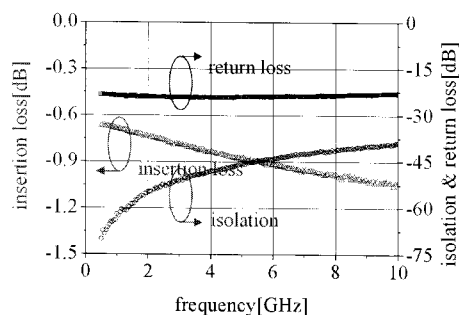

Fig. 11. Isolation and insertion loss characteristics of see-saw type RF MEMS switch.

VI. CONCLUSIONS

This paper has demonstrated the see-saw type RF MEMS switch which has 46dB isolation at 5GHz, 0.9dB insertion loss at 5GHz and 40V actuation voltage. To reduce the actuation voltage and get the narrow gap, we have utilized the reduced-gap silicon deep etching process and developed a new process to overcome alignment limitation of the vertical comb. Although the fabricated switch does not exactly match its designed parameters, it is sufficiently proven that switches with good characteristics can be fabricated using this vertical comb structure. Additional package and process for the interconnection will be performed.

ACKNOWLEDGMENTS

The authors wish to acknowledge the assistance and support of the Center for Advanced Transceiver Systems and the Ministry of Commerce, Industry and Energy of Korea.

REFERENCES

- [1] Gabriel M. Rebeiz, Jeremy B. Muldavin, "RF MEMS Switches and Switch Circuits," *IEEE Microwave Magazine*, pp.59-71, December 2001.
- [2] Dimitrios Peroulis, Sergio P. Pacheco, Kamal Sarabandi, Linda P. B. Katehi, "Electromechanical Considerations in Developing Low-Voltage RF MEMS Switches," *IEEE Transactions on Microwave Theory and Techniques*, Vol. 51, No. 1, pp. 259-270, January 2003.
- [3] Joachim Oberhammer, Goran Stemme, "Low-Voltage High-Isolation DC-to-RF MEMS Switch Based on an S-shaped Film Actuator," *IEEE Transactions on Electronic Devices*, Vol. 51, No. 1, pp. 149-155, January 2004.
- [4] Lei L. Mercado, Shun-Meen Kuo, Tien-Yu Tom Lee, Lianjun Liu. "A Mechanical Approach to Overcome RF MEMS Switch Stiction Problem," *Electronic Component and Technology Conference*, 2003.
- [5] Hector J. De Los Santos, Georg Fischer, Harrie A.C. Tilmans, Joost T.M. van Beek, "RF MEMS for

Ubiquitous Wireless Connectivity,” *IEEE Microwave Magazine*, pp.36-49, December 2004

- [6] Jong-Man Kim; Jae-Hyoung Park; Chang-Wook Baek; Yong-Kweon Kim, “The SiOG-based single-crystalline silicon (SCS) RF MEMS switch with uniform characteristics,” *Journal of Microelectromechanical Systems*, Vol. 13, Issue 6, Dec. 2004, pp.1036 - 1042.
- [7] M. Sakata, Y.Komura, T.Seki, K.Kobayashi, K. Sano, S. Horiike, “Micromachined relay which utilized single crystal silicon electrostatic actuator,” *12th IEEE International Conference on. (MEMS)*, pp.21-24, 1999.
- [8] Il-Joo Cho, Taeksang Song, Sang-Hyun Baek, Euisik Yoon, “A Low-Voltage and Low-Power RF MEMS Series and Shunt Switches Actuated by Combination of Electromagnetic and Electrostatic Forces,” *IEEE Transactions on Microwave Theory and Techniques*, Vol. 53, No. 7, July 2005.

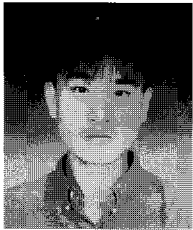

Sungchan Kang received the B.S. in mechanical engineering from Seoul National University, Korea, in 2004. He is currently a Ph.D. candidate in Seoul National University, researching in the areas of the RF MEMS. He is

interested in the RF MEMS switch and tunable filter.

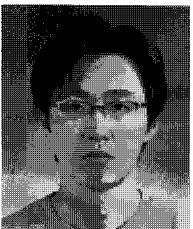

Sungsoo Moon received the B.S. in mechanical engineering from Seoul National University, Korea, in 2001. He is currently a Ph.D. candidate in Seoul National University, researching in the areas of the RF MEMS. He is

interested in the RF MEMS capacitor and switch.

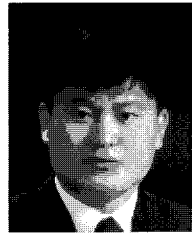

Hyeon Cheol Kim received his M.S. and Ph.D. degrees in electronic engineering from Seoul National University in 1992 and 1998, respectively. He has worked as a BK21 contract assistant professor in Seoul National University from 2004 to 2006. He is currently a research fellow in u-IT Cluster Center of National Information Society Agency in Korea. His areas of research include Micromachining, Semiconductor sensors, RF MEMS, MOEMS, IMU, integrated MEMS and SoC Packaging.

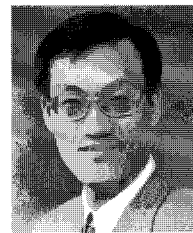

Kukjin Chun received the B.S. degree in Electronics Engineering from Seoul National University in 1977 and the M.S. and Ph.D. degrees in Electrical Engineering from the University of Michigan in 1981 and 1986, respectively. He was an Assistant Professor in the Department of Electrical and Computer Engineering at Washington State University from 1986 to 1989. He joined the faculty of Seoul National University in 1989, where he is currently a professor in the School of Electrical Engineering. He is a Senior Member of IEEE and a Life Member of IEEK. He has been a director of Center for Advanced Transceiver System since 2000, which develops RF front-end solution for next generation wireless communication system. His research interests include integrated sensors, intelligent Microsystems and MEMS processing technologies.