

Design and manufacture of mini loop coil probe style magnetic curer for peripheral nervous system treatment

Kim, Whi Young (Dongju College, Dept of Biomedical Engineering)*

Choi, Jin Young (Busan University, Dept of Electrical Engineering)**

Park, Sung Jun (Busan University, Dept of Electrical Engineering)***

Kim, Hee Je (Busan University, Dept of Electrical Engineering)****

Abstract

It is as result that study to apply mini magnet nerve curer in peripheral nervous system disease treatment. Design and embodied action power and Control Unit in cylinder form of magnet roof object firstly. Yielded service area about special quality of probe of roof object cylinder style and treatment area dimension and distance of treatment pulse secondly. Embody pulse forming course energy value by Probe's form by third, could embody treatment pulse by disease. Specially, through a special quality experiment, saved Damping pulse form and treatment pulse form etc. variously. Lately, embodied this to aid a little in disease treatment that follow that there is no invasion that there is no stimulation by medicine development. Go amplitude treatment pulse (traditional magneto-therapy of greatly great that strong) does curative effect greatest at short time and becomes thought that demand is magnified greatly at the future in this research.

Keywords: mini magnet nerve curer, magneto-therapy, pulse forming

* Professor, Department of Biomedical Engineering, Dongju College, ndyag@dongju.ac.kr

** Graduate School of Electric Engineering Busan National University, jinyoung@pusan.ac.kr

*** Graduate School of Electric Engineering Busan National University, co2laser@pusan.ac.kr

**** Professor, Electric Engineering Busan National University, heejekim@pusan.ac.kr

1. Introduction

Existent electricity stimulation radical touches directly in body, and can have sore but magnetic stimulation account is no contact, and application extent is widened extensively by muscle disease system etc., in various nerve diseases that there is no invasion. If explain living body effect about magnetic to basic principle, human body that is lain in the courteousness receives power failure induction and range charge for all direction on the human body surface. Because dielectric substance put among ago causes heredity polarization, electricity dipole that correspond for monetary unit is ranged, phenomenon that hair stands within strong electromagnetic is the example. Because hair receives force in, laudable custom is correct impression in about 200kV/more than ms usually. If discharge happens in pointed end department of living body in hard fighting of 2,000kV/more than ms, red heat stuff or skin if is surface of the body that feel mordant prompt by hands of a clock in relationship peripheral nerve influence can. Electromagnetic field's strength is not and difference of magnetic field house, direction of magnetic field, east or curl, dimension of part that strong magnetic field occurs or action time, other energy that do fire uniformity if is uniformity magnetic field, existence and nonexistence etc., of interference action can become an issue mutually with electric wave, radiation, supersonic waves for example, and, induced current is passed in living body in interchange full length as life of telling kind passes in living body in interchange magnetic field.

Effect for human body examined about blood pressure, heart beat, ECG, brain waves, reaction time, blood ingredient and so on, but there is presence at a sickbed data that could not see effect to strength of 20kV/ms. By next time, thermo-genesis action of high frequency and living body action of ultrahigh frequency electromagnetic field is subject. Electron energy can know heated point because is assimilated as is easy in living body. By thermo-genesis effect electromagnetic waves absorption of living body than 30MHz enough daytime in frequency because wave length is long fairly than

size of living body living body size or anatomy of interior and interference with wave length almost have. Energy absorption is most in surface of body, and reduce power of a number functionally for interior of the body deep part direction. But, because frequency rises, if $1/4$ of wave length amounts to near worth in human's kidney, resonance in whole body begins to show and energy absorption begins to increase rapidly. If frequency becomes more than 30MHz, strong resonance occurs in frequency that is wave length 3~4m neighborhood that class conclusion of state examination of electro-magnetic waves coincides in extension without can ignore interference with living body size and energy absorption gets into maximum. Think safety of electromagnetic waves by heat actions, this 30~300MHz nearby frequency band is most important and there is danger that part that go such as neck, joint to disappear, ankle in resonance state of standing up height direction is heightened strongly. In this way, it is no contact because deriving money on human body interior and there is no invasion and come at recent times to tip of a twig nerve, brain disease, cranial nerve, muscular power, main point incontinence, old man disease, muscle disease, rehabilitation treatment etc., by advantage that stimulation of deep and wide region is possible and research is a buzz afoot vigorously self-discipline which magnetic stimulation radical changes by time.

Finally, it is as result that study to apply magnetic nerve curer in peripheral nervous system disease treatment as is super beauty. Design and embodied control unit with action power in cylinder form of own roof object firstly. Secondly, yielded service area about special quality of probe of loop object cylinder style and treatment area dimension and distance of treatment pulse. Third embodies pulsed forming and energy value by probe's form, could embody treatment pulse by disease. Specially, through a special quality experiment, saved damping pulse form and treatment pulse form etc., variously. Lately, embodied to aid anything in disease treatment that is no stimulation by medicine development, and invasion. High amplitude treatment pulse(traditional magneto-therapy of greatly great that strong) does curative effect greatest Tuesday at short time and is predicted that demand is magnified greatly at the future in this research.

II. Systems Design and Embodiment

2.1 Power supply of super mini probe insertion style curer

One-phase full bridge inverter is consisted of center, and inverter acts by ZVS. Have by-pass mode and two action modes of backup mode even if power is expired. There is TRIAC in on state in By-pass mode and electric power is passed and do all current waveform improvements of uninterruptible power form and battery electrification almost directly as subordinate from entire membership. Output voltage is depended on power supply voltage in this mode. There is TRIAC in off state in Backup mode and uninterrupt entire membership supplies AC electric power in load being supplied DC electric power from battery. This time, output voltage keeps one constant voltage schedule frequency. Current that UPS passes in rural districts side in By-pass mode is controlled so that become sinewave being voltage and ditto.

Figure 1. Power supply of super mini coil probe own curer for peripheral nervous system treatment

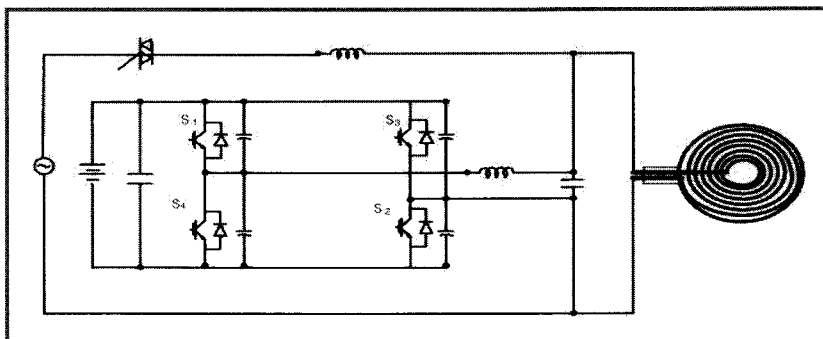
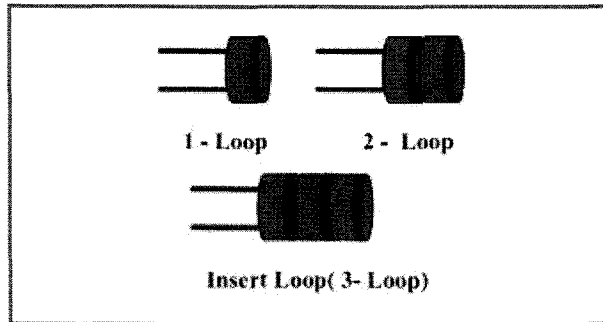

Figure 2. Insert Loop Coil Probe



This time, can explain by flow of electric power if consider fundamental wave quantity of load current. Battery is and leaves out two in small charge (trickle charge) state if charging current ignores because is small all in because electric power that is flowed in is passed to all loads I1 following size have.

$$I_1 = \frac{V_2}{V_1} I_2 \cos \phi \quad \text{-----} \quad (1)$$

Inverter supplies subordinate's nullity electric power and nullity electric power of power side does not pass. This action is same with nullity electric power compensation flag(SVC : Static VAR Compensator). Car current of flowing current is passed to inverter $I_2 \sin \varphi$ and capacitor C_p that is subordinate's nullity electric power minute. Is given as load voltage following. If Battery is charging, power current way grow than is expressed and charging current is given as following this time. Can control I1 and regulate Battery charging current even if there is no special charger. If control of system of harmonic exclusion function and power-factor improvement consists normally, input current becomes sinewave. Thing which degree of harmonic of subordinate side is low is supplied in inverter and high harmonic current is supplied in parallel capacitor.

$$\dot{V}_2 = \dot{V}_1 - jX_L \dot{I}_1 \quad \text{-----} \quad (2)$$

Harmonic current that happen of inverter action is passed by this capacitor. Act by spontaneity electric power acceptor(Active Power Filter). If is cut off the electricity, must form interchange military strength being supplied electric power in Battery, and must deliver as subordinate because entire membership is supplied in commercial power if is gotten back again. Because become as power side is short-circuited as many subordinates who is coupled at power failure, did to shut off power side by TRIAC if is decided to cease-fire. At this process, control roof does switched but to do and do switched safety specification control circuit use. Because voltage that escape at zero-crossing neighborhood are small, reserve finding.

$$I_B = \frac{I_1 V_1 - I_2 V_2 \cos \phi}{V_{DC}} \quad \text{-----} \quad (3)$$

U11C supplies same flag signal to logic circuit to happen being done winter season when switched of controller is zero-crossing of standard signal. Logic circuit part of circuit comes true by AVR Chip microprocessor. If accident is happened, processor TRIAC's gate signal immediately remove and controller does switched winter season to keep output voltage of constant voltage domiciliation watch. Do controller switched winter season to input TRIAC's gate signal winter season and control input voltage if is gotten back in armistice. By next time, own pulse curer being electric field E that origin of action is acquired from Faradays law, is given by Biot-Savart rule in case is a magnetic field that B is produced by coil. $4\pi \times 10^{-7}$ H/m can appear by permeability from freedom space, and have and act coil winding C A vector dl synthetically.

Figure 3. Battery charging curve

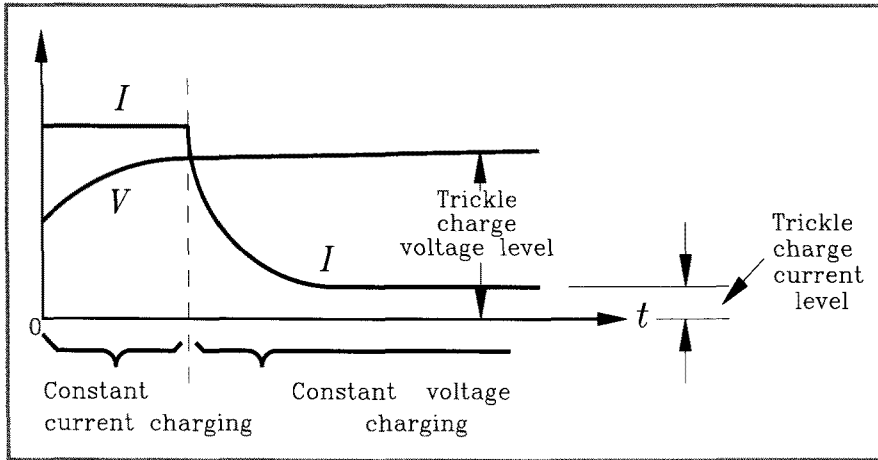

Current pulse occurs by discharged capacitor CCT that is linked in winding coil by series by SCR. First, produce capacitor's discharge through inverse coil to capacitor, gate of interval riss site that charge to 2-3kVs. Current wave style do peak as a result at least A 5 - display 10kAs, 300mS, and have current that become typical damping . Guided E is strongest near coil, and usually stimulate outer covering area of some centimeter in diameter.

$$B(r,t) = \frac{\mu_0}{4\pi} I(t) \oint_c \frac{dl(r') \times (r-r')}{|r-r'|^3} \quad \text{-----} \quad (5)$$

Pulses of self-stimulation flag are occurred in near place of neurone in stimulated sacred ground, as well as, change to occurrence by synaptic input. In microscopic level, E with transmembrane voltage of neurone, and influence to voltage-sensitive ion channel by it. Brain imaging tools can be used and change in blood current of metabolism to find stream about mixed electricity. In motor-cortex stimulation, peripheral device effect can be observed as muscle activity to surface electromyography(EMG).

2.2 Loop-coil probe insert's design

Figure 4 displays Loop-coil probe's structure and design drawing. As see in figure 4, miniaturize size epochally and added 1 - roof, 2 - loop according to disease state, 3 - roof, 4 - loops, 5 - loop, 6 loops, 7 - loops, 8 - roof, 9 - loops, 10 - loops. Because done length 15cm, diameter 1.5cm, hole 0.5cm to be imposed in state that can scam again, design and manufactured. Composed so that ordinary people can use or anyone conveniently easy.

Figure 4. If is Loop-Coil probe composition and plan

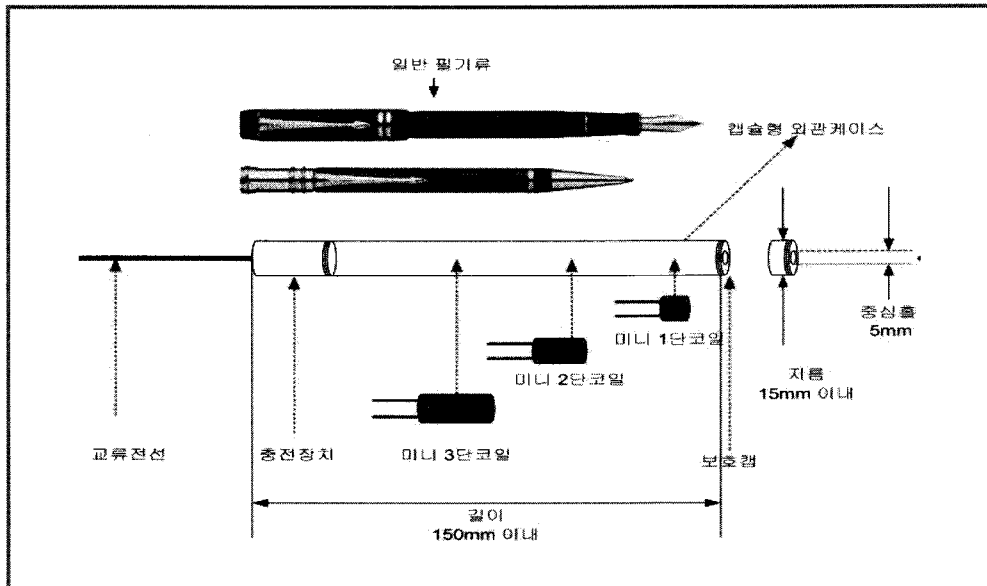

Figure 5. Loop-coil probe's output treatment pulse comparative analysis

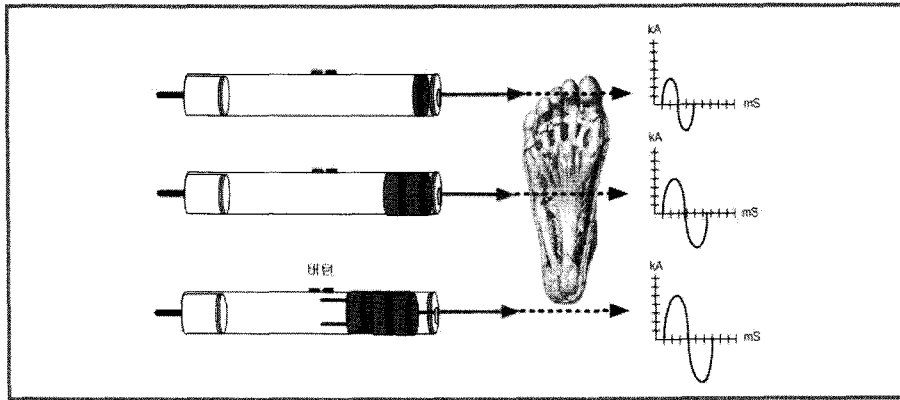
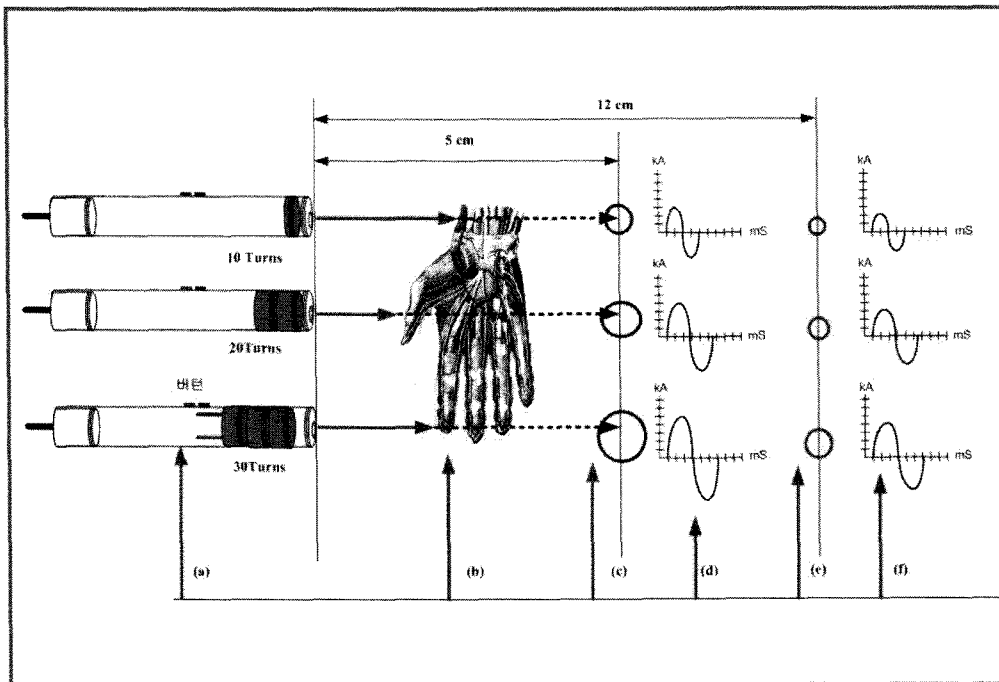

Figure 6. Loop-coil probe's treatment pulsed relationship special quality analysis



Composed so that ordinary people can use or anyone conveniently easy. When it is 1 - when it is loop, treatment pulse is 0.5kA, 2 - loop, treatment pulse is 0.75kA, and when it is 3 - when it is loop, treatment pulse is 1kA, 4 - loops, treatment pulse is 1.3kA, and when it is 5 - when

it is loop, treatment pulse is 1.6kA, 6 - loops, treatment pulse is 2kA, and when it is 7 - when it is loop, treatment pulse is 2.3kA, 8 - loops, treatment pulse is 2.6kA, and approximate and is less than 1/10 in price because output gouges 70% than system that when it is 9 - when it is loop, treatment pulse is 2.9kA, 10 - loops, treatment pulse is general by 3kA degree, and it becomes thought that do not fall behind entirely on 1/100, performance side in bulk aspect. Figure 5 is output treatment pulse comparative analysis data that is expressing size of treatment pulse waveform and treatment area according to Loop-coil probe's quantity. Figure 6 expresses effective distance of treatment pulse and treatment area according to Loop-coil probe's quantity and distance, and (a) displays roof coil's probe external appearance, and (b) writes hand that can do palm and treatment, and (c) is expressing treatment pulse radius. By next time, treatment area is displaying thinness that get worn out sharply if (d) treatment pulse's size is different according to numeric of coil's insertion and 12cm of (e) exceeds. (f) is displaying sudden decrease of treatment pulse.

If supplement treatment extent and concept, is suitable to motor point treatment in Oriental medicine field, to very convenient system in modern medicine field design or that is possible to one item of smaller enterprise if supplement in short time clinically see. Path that connect skin that utilize room or note treatment or important reaction point that appear in muscle and this reaction point. According to room, especially disease pipe of note treatment, human body is account book, and is healthy if function is harmonized each other, but do that various kinds symptoms show because is cankered if floral tributes scatters.

It refers to this that is blood vessel though there is energy circulatory system that refer to and pass on leg in head, on arm in chest, indeed for length interior and exterior of body that regulate always function of this account book. Five vatal organs and the six viscera five chairmans speak liver · heart · spleen · lungs · kidney, caruncle refers to head · head · gall · grade · flax seconds · bladder and so on. Chapter interior indicates faithful thing, the wealth indicates empty institution on the contrary.

That is five vatal organs and the six viscera once upon a time, used but used that attach six months in coming age and is five vatal organs and the

six viscera.

Chapter and the wealth mean which is warehouse. Spoke that is "Five chairmans are not wealthy because keeping spirit and energy, have not poured and fill, and because caruncle hands down parcel without keeping, do not fill because is healthy. This chairman is wealthy if water infiltrates on mouth, stomach is healthy and merit becomes hollow and food ascends and latitude becomes hollow . Therefore, because is healthy without filling, filling healthy" in hard fighting of Oriental medicine. Also, account book is explaining functional correlation by oriental nat. phil. called sun and the moon five elements New Year depending on five elements.

Is used into inside of the stomach · heart · intention of body inside and so on usually. Because there are six market days of the month and caruncle in tenon, there is politico-economic 12 wonders which name of each account book sticks to blood vessel corresponding to this, there are 8 pulses about mourning besides.

Doing 14 wonders mixing 2 sutras that pass whole surface very middle of body and back very middle specially 8 pulses middle about mourning and this blood vessel of here and there energy lump place, place that is apt to collect be .

Although modern curer does not believe such ancient China's account book blood vessel loan entirely, is essential important disease judgment or treatment in actuality presence at a sickbed. This phenomenon is expose by ring shape · word shape with that wind belt in body, this belt therefore specially reaction strong .

Here and motor point have much work that coincide.

2.3 Embodiments of carrying along style multistage probe of various disease

Figure 7. Loop-coil probe's sticking area

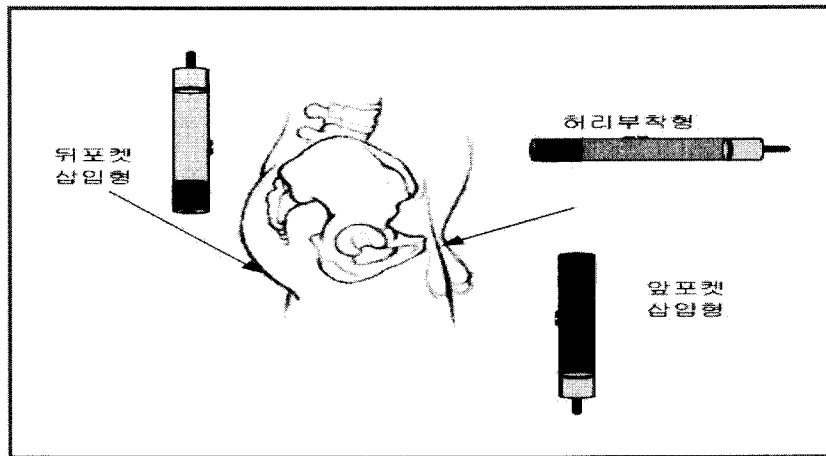

Figure 8 of(a) in main point incontinence, prostate of(b) figure 5, sphincter, nervous system of(c) figure 8, headache, retrogression arthritis, ligament damage of(d) figure 8, Ryumatisum arthritis, tip of a twig nerve etc. proper probe's treatment pulse come out. Specially, it is function during rise time of limit capacitor energy and E peak value zero-to-peak. Value 100ms' time rise raise that general. Inductance $L = 20\mu\text{H}$ and resistance = 50mohm .capacitor C reaches from 20 to 600uF. Current form is = 150ms as bi-phasic and number t of thin film awarding. Energy-continuance curved line is leveled far about continuous value for very short pulse that is not looked although. Though there is 2 stimulation flag type, it is single pulse devices and devices that repeat that lay stimuli's train in 60Hz in 1. Can have that is added to their single pulsation devices could use to drive 1 coil in pulsations that is classed by 1 to 1 ms module. Can do better control in space wide area of stimulation. It is easy that another important development drives stimulation consecutively in 50Hz in 1. Model of stimulation that wear magnetic is important racket in research of machines of venue, degree and magnetic pole analysis and design of experiments, it is become an effective tool. Though model embodiment separates by important 2 branches, neural

response result by calculation of electromagnetic fields and electricity discharge that look on naked eye by flowing in priority, coil forms thin film impalpably.

Current $I(t)$ in coil produces magnetic field B that is derived by electric field E . B through coil indeed, lungs roof mortification E line, high position right side can explain that appear in central gyroscope side form in hemisphere really. 2 pyramidal axon is seen with typical direction of intracranial E . There are see devices are paired-pulse or quadruple-pulse stimulants. 2 stimulation unit become independent coils stimulate other fat at the same time or continuously use can .

By peculiar coil cooling, speed of the stimulation train can be limitless. Specially, woman could observe in a special quality experiment that 2 loops 3 pulses are valid than 1 roof.

III. Experiment Result

Figure 8. High tension output (400V), coil both end output (9 KV), (10 KV)

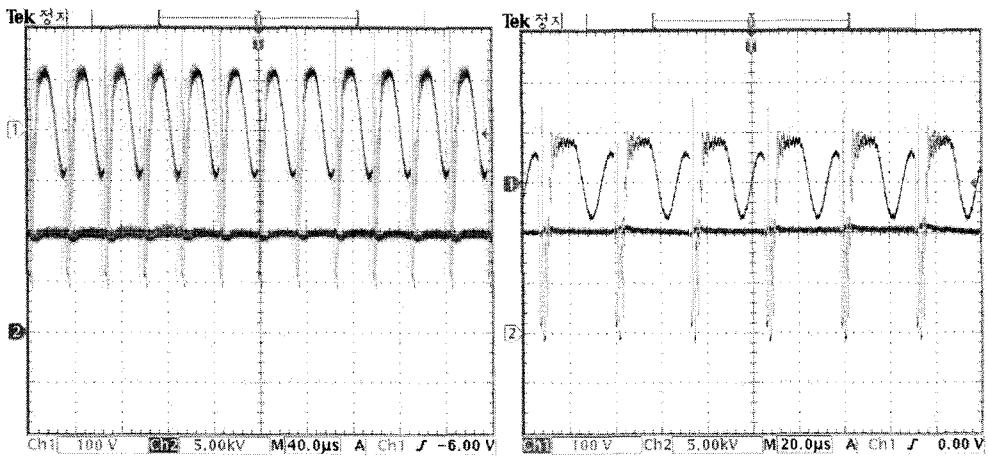

Figure 9. High tension output (420V), coil both end output (12 KV), (423V)

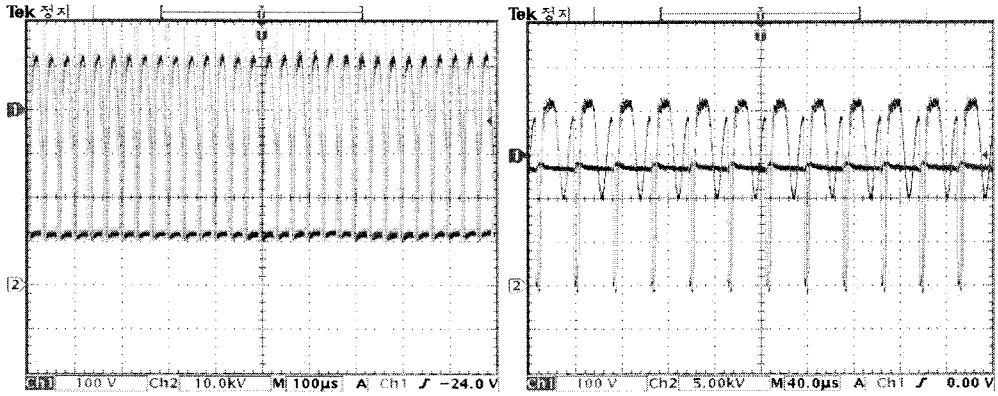

Figure 10. High tension output (430V), coil both end output (12 KV), (433V)

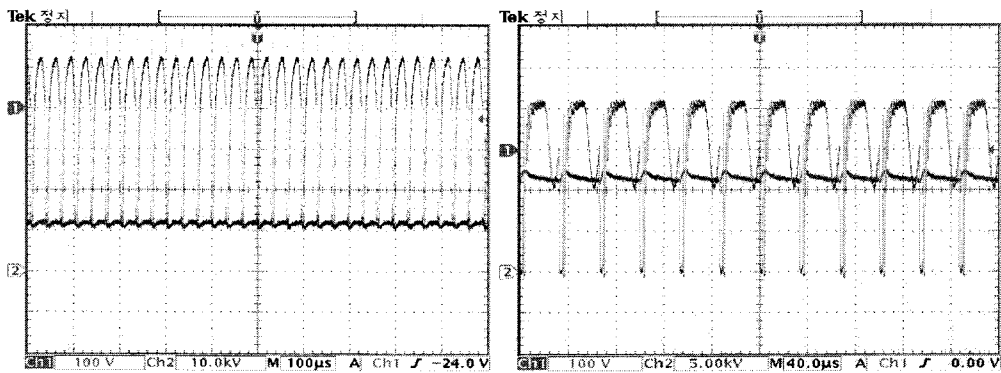
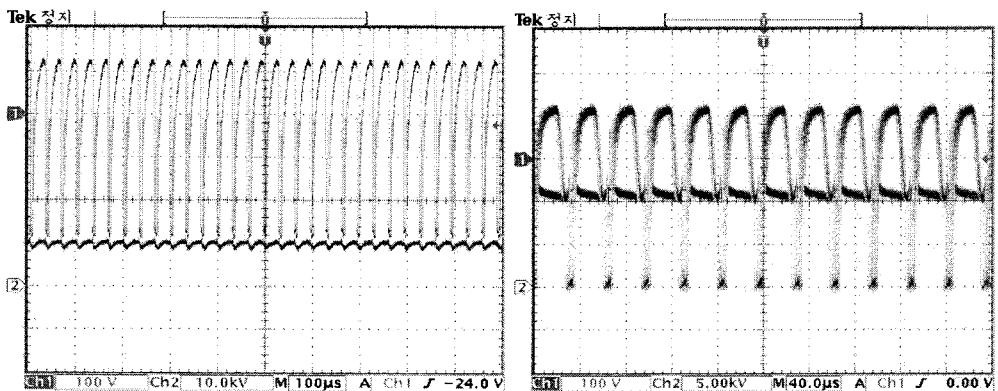

Figure 11. High tension output (435V), coil both end output (13 KV),(438V)



IV. Conclusion

Magnetic Filed that Magnetic stimulation radical changes by time without deriving Electronic Field on human body interior invasion, come at recent times to tip of a twig nerve, brain disease, cranial nerve, muscular power, main point incontinence, old man disease, myopathy, Rehalibitation treatment by advantage that stimulation of wide region is possible and research is progress middle abuzz vigorously. It is as result that study to apply Super mini magnetic nerve curer in peripheral nervous system disease treatment. Firstly, design and embodied control unit with action power in cylinder form of magnetic loop object. Secondarily, yielded service area about special quality of probe of roof object cylinder style and treatment area dimension and treatment pulse's distance. Thirdly, embodied pulse forming and energy value by probe's form. Could embody treatment pulse by war.

Specially, through a special quality experiment, saved damping pulse form and treatment pulse form etc. variously. Lately, by medicine development innocuously, embodied to aid anything in disease treatment that follow without invasion. High amplitude treatment pulse (there is greatly great strength of traditional magneto-therapy.) does curative effect greatest Tuesday at short time and is predicted that demand is magnified greatly at the future, and is seen that research is serious in this research.

References

- J. K. R. Weber, J. J. Felten and P. C. Nordine(1996), "laser Hearth Melt Processing of Ceramic Materials", *Review of scientific Instrum*, Vol.67, No.22, pp.522-524.
- P. Loosen(1992), "Recent Development of lasers for Materials Processing", Proc of LAMP '92, Nagaoka, Vol.1, pp.61-66.
- W. Y. Kim(2000), "The new type pulsed Nd: YAG laser power supply employed multi-amplification method", ACED-2000.
- 김휘영(2006), "근조직 재활치료를 위한 자계신경 자극시스템의 설계 및 구현", 『2006년도 하계종합 학술대회 논문집Ⅱ』, pp.855-856.
- 김휘영(2006), "Fracture환자의 무자극 재활촉진을 위한 촉진형 다층치료기의 구현", 『2006년도 하계종합 학술대회 논문집Ⅱ』, pp.857-858.
- 김휘영(2006), "모바일 기반의 HRV 인터페이스러리에 대한 생체계측시스템", 『2006년도 하계종합 학술대회 논문집Ⅱ』, pp.857-858.
- 김휘영(2006), "Photosensor를 이용한 재활치료형을 위한 co2 laser의 출력변동률 안정을 위한 실시간 제어특성연구", 『2006년도 하계종합학술 대회 논문집Ⅱ』, pp.857-858.
- 의공학교육연구회(1998), "의용계측공학", 여문각.

말초신경계 치료를 위한 초미니 Loop-코일프로브 삽입형 자기치료기의 설계 및 제작

김휘영* · 최진영** · 박성준*** · 김희제****

국문요약

열작용에 의한 전자파의 안전성을 생각하는데 있어서는, 이 30~300MHz 부근의 주파수대가 가장 중요하고 기립 신장 방향의 공진 상태에서는 목, 슬 관절, 발목 등 가는 부분이 강하게 가열되는 위험이 있다. 이처럼 자기자극기는 시간적으로 변화하는 자계를 인체내부에 전계를 유도하여 무접촉성, 무침습적으로 깊고, 넓은 부위의 자극이 가능한 이점으로 말초신경, 뇌질환, 뇌신경, 근력, 요실금, 노인성, 근질환, 재활치료 등까지 근래에 와서 활발하게 연구가 활발히 진행 중이다. 마지막으로 초미니 자기신경 치료기를 말초신경계 질환치료에 적용하기 위하여 연구한 결과, 첫째로 자기 루프 객체의 실린더 형태로 설계하고 동작전원과 제어장치를 구현하였고, 둘째로 루프 객체 실린더형의 프로브의 특성과 치료영역 범위와 치료펄스의 거리에 대한 유효영역을 구하였고, 셋째로 프로브의 형태에 따른 펄스포밍과 에너지 값을 구현하여, 병변에 따른 치료펄스를 구현할 수가 있었다. 특히, 특성실험을 통해 댐핑펄스 형태와 치료펄스 형태 등을 다양하게 구하게 되었다. 최근에 의학 발달로 무자극, 무침습에 따른 질환치료에 조금이라도 도움이 되고자 구현 하였다. 본 연구에서는 고진폭 치료펄스(전통적인 magneto-therapy의 크게 대단한 강렬)는 짧은 시간에 치료효과를 극대화 하고, 미래에는 수요가 크게 확대 될 것으로 예측된다.

핵심주제어: 자기신경치료기, magneto-therapy, 펄스포밍

- * 동주대학 의료기공학과 조교수
- ** 부산대학교 전기공학과 박사과정
- *** 부산대학교 전기공학과 박사과정
- **** 부산대학교 전기공학과 교수