

Medium Voltage HTS Cable Thermal Simulation using PSCAD/EMTDC

Chaekyun Jung[†], Yeonwoog Kang, Jiwon Kang

KEPCO Research institute, Korea Electric Power Corporation, 105 Munji-Ro, Yuseong-Gu, Daejeon 34056, Korea

[†] chekyun@kepc.co.kr

Abstract

This paper described the medium voltage high temperature superconducting cable thermal simulation and its application. New simulation method for HTS cable modeling using PSCAD/EMTDC is introduced in this paper. The developed simulation method consists of electrical model part and thermal model part. In electrical model part, power loss and thermal capacitance can be calculated in each layer, then the temperature of each layer can be calculated by power loss and thermal capacitance in thermal model part. This paper also analyzes the electrical and thermal characteristic in the case of normal operating condition and transient including single line to ground fault and line to line ground fault using new simulation method.

I. INTRODUCTION

High temperature superconducting (HTS) cable has low power loss and high power capacity. The capacity is several times larger than conventional cables in the same voltage level because of huge current. HTS cable can carry the huge current below critical current without ohmic power loss. Recently, the technology of HTS cable is now getting closer to commercialization [1]-[4].

For application of HTS cable in real power system, the thermal characteristics and transient analysis are very important. For more exact and various analysis, reliable simulation model is required for evaluating effects of HTS cable system [4].

Therefore, in this paper, new modeling technique for thermal characteristics analysis of medium voltage level HTS cable is developed using PSCAD/EMTDC program [5] which is one of the simulation programs for transient analysis of power systems. The newly developed modeling technique can express quenching due to hot spot which is occurred at specific position during various faults. In general, HTS cable will not quench uniformly along the length of cable during a fault. Initially, specific part of cable will quench, then the quenching will spread along the length of cable. In order to consider this phenomenon, firstly, new HTS cable model is divided by electrical model part and thermal model part. In electrical model part, power loss and thermal capacitance can be calculated in each layer, then the temperature of each layer can be calculated by power loss and thermal capacitance in thermal model part. And then, finally, the resistance of each layer can be calculated in electrical model part using temperature calculated in thermal model part. In addition, both the electrical model part and thermal model part is split in 2 sections such as small part and large part for express of quenching phenomenon. These 2 sections are modeled in series in each layer. HTS simulation model developed in this paper is very special for analysis thermal characteristics.

In this paper, medium voltage level of 22.9 kV is considered for modeling. The total length of cable is supposed to 500 m including 1 m of small section and 499 m of large section. Finally, the temperature in each layer and LN_2 bubble point are evaluated by developed simulation model according to

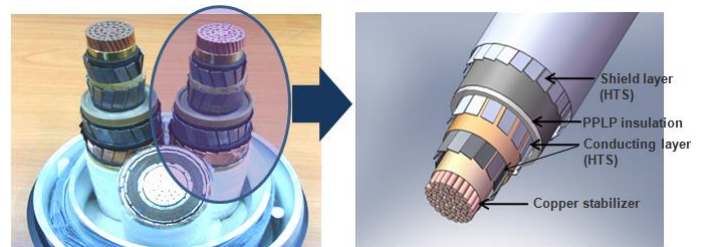

Fig. 1. Configuration of this HTS cable

several kinds of faults.

II. STRUCTURE OF HTS CABLE

The medium voltage level of 22.9 kV with 3 phase HTS cable is used for modeling in this paper. It has already been developed by one of Korean manufacturers. The configuration of this HTS cable is presented in Fig. 1. As shown in Fig. 1., 3 phases HTS cable in one cryostat consists of former (copper stabilizer) - HTS conducting Layer (2 layers) - PPLP Insulation - HTS shield layer - copper shield stabilizer - inner aluminum cryostat - Outer aluminum Cryostat - PVC Sheath. The specifications including detail layer and material are expressed in Table 1. The critical current of HTS conducting layer is 2,700 A, and designed cable pressure is 3 bar. In this paper, the bubble point is analyzed at 3 bar as well as 14 bar which is designed in other installations during a fault.

III. PSCAD/EMTDC MODEL

In this paper, the HTS cable model has two main parts, an electrical model and thermal model. The electrical model is primarily responsible for calculating the resistance and power loss of each of the various layers of the HTS cable as a function of responsible for calculating the temperature of each layer as a function of the power loss in each layer and the cable thermal characteristics. Fig. 2 provides an overview of the model. In Fig. 2, the approach assumes all aspects of the cable are constant along the length of the cable. However this is not true. In particular, the temperature of the cable varies along the length such that the inlet of the cable is 70 K while the outlet is 74 K.

Table 1. Specification of HTS cable

| Item | Material |
|-------------------------|----------------------|
| Former | Copper |
| 1st HTS Tape Layer | Superconductive wire |
| 2nd HTS Tape Layer | Superconductive wire |
| Insulation | PPLP |
| Shield HTS Tape Layer | Superconductive wire |
| Shield Stabilizer | Copper |
| Inner Aluminum Cryostat | Al |
| Outer Aluminum Cryostat | Al |
| Sheath | PVC(PE) |

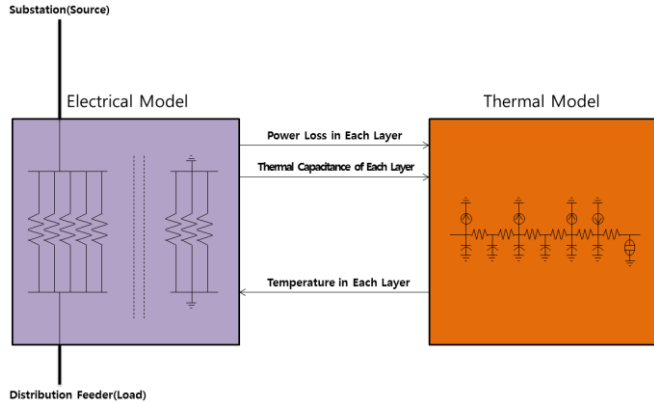

Fig. 2. HTS cable model overview

In addition, it is known that the properties of the HTS wire can vary within a manufacturing tolerance along the length of the wire. In an extreme case, the HTS wire may have a significantly lower critical current or differ in some other way in one small section of the cable.

It is very important to account for this as it is known that, during a fault, an HTS cable will not quench uniformly along the length of the cable. Rather, one small part of the cable will initially quench (usually the warmest part of the cable) and then the quenching will spread along the length of the cable. To account for the actual and potential differences along the length of the cable, the model described in Fig. 2 was expanded. Both the electrical and thermal model was split in two such that essentially two cables in series were modeled. One set of models would represent 1 m of the cable while the other would represent the other 499 m. The total length of 22.9kV HTS cable used in this paper is 500 m.

The HTS Model consists of ‘Cu Former + HTS Conductor’, HTS Shield and Al Cryostat. HTS cable is modeled by PSCAD/EMTDC. Firstly, in this paper, Former and Conductor parts has been modeled with former, HTS layer and normal layer. Fig. 4 shows HTS cable structure split by 2 sections in detail. The model described in Fig. 4 is what was used for all simulations. In this paper, the model assumes a perfect insulation layer between the former and the inner HTS tape layer, between the inner HTS tape layer and the outer HTS tape layer, and between the shield HTS layer and the shield stabilizer. In all cases it is assumed that the various layers are solidly connected together at the terminations (i.e. the former and the two HTS layers are bonded together and the shield HTS, shield stabilizer, and both cryostats are bonded together and to ground) but are not bonded along the length of the cable. Fig. 5

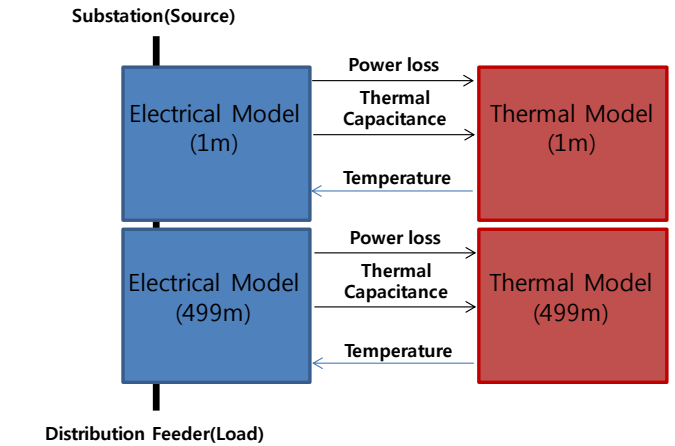

Fig. 3. HTS cable model split by 2 sections

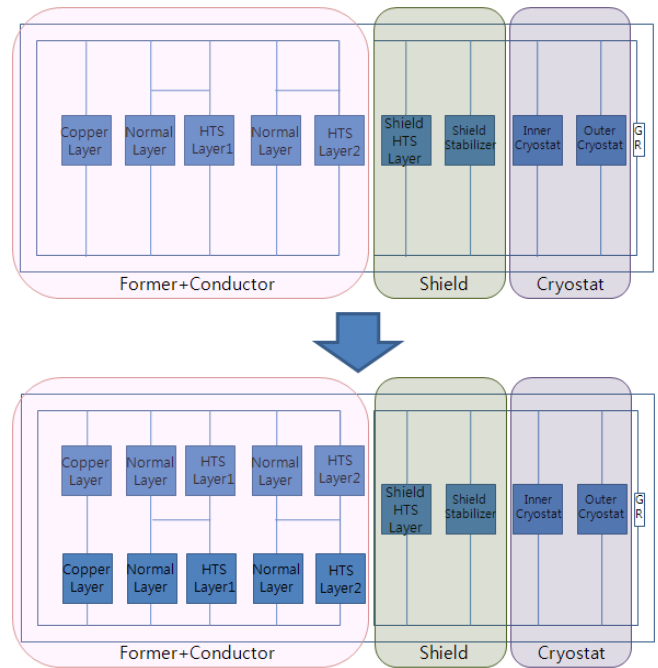

Fig. 4. HTS cable structure split by 2 sections

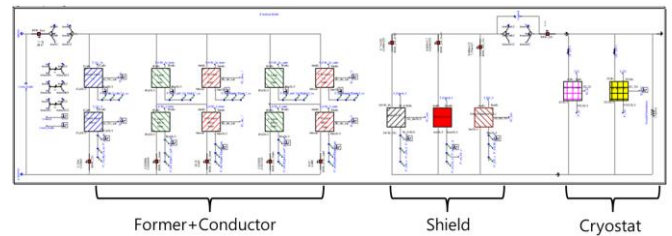

Fig. 5. HTS cable PSCAD/EMTDC modeling structure (2 layers HTS)

shows the HTS cable PSCAD/EMTDC model applied in this paper. As shown in this figure, HTS cable structure has 2 layers HTS conductors.

IV. APPLICATION OF PSCAD/EMTDC MODEL

22.9 kV HTS cable system has been modeled by HTS cable modeling technique developed in this paper using PSCAD/

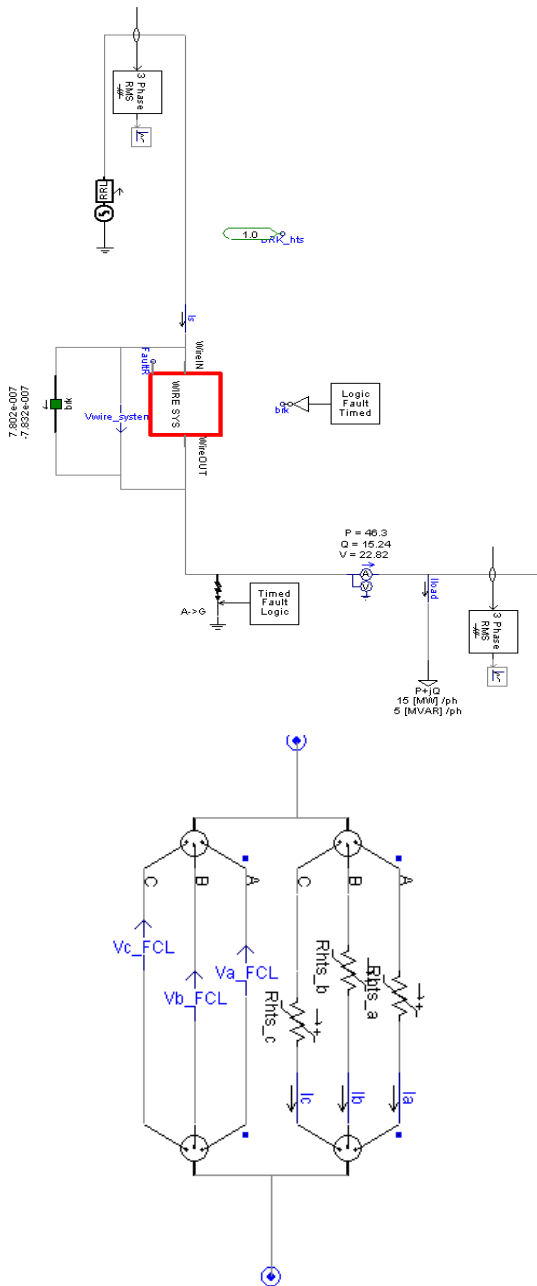

Fig. 6. 22.9 kV HTS cable system PSCAD/EMTDC model

EMTDC. Fig. 6 shows the HTS cable system diagram. As shown in Fig. 6, this system has 22.9 kV source and load of 15 MW. HTS cable length is 500 m, and this length is divided by 1m and 499 m. The temperature of the inlet and outlet of cable are applied by 70 K and 74 K, respectively.

In normal operating condition, Fig. 7 shows instantaneous current waveform of HTS cable in each layer of phase A. Fig. 7, firstly, includes the layers the in the ‘conductor’ of the HTS cable and include the former, HTS layer 1, HTS normal 1(the current in the normal, or non-HTS, portion of the HTS tape), HTS layer 2, and HTS normal 2. The graph also represents the current in the shield of the cable and includes the shield copper, shield HTS and shield HTS normal. These currents are induced by the mutual coupling between conductor and the shield. This graph, finally, represents the ground current flowing in the inner and outer cryostats. Fig. 8 shows only important layers of the

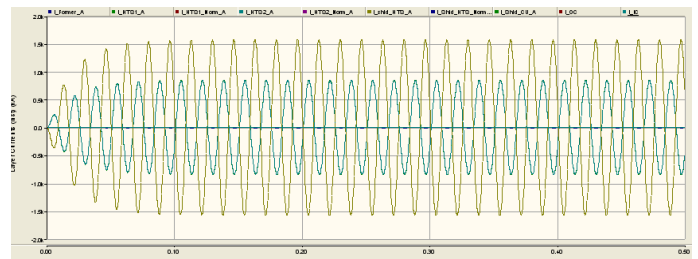

Fig. 7. Instantaneous current of HTS cable in normal operating condition

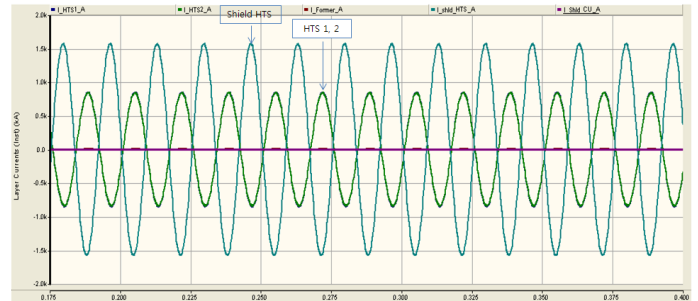

Fig. 8. Instantaneous current of only important layers of the cable in the conductor and shield

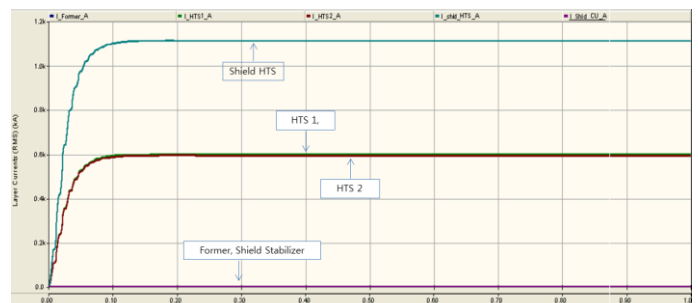

Fig. 9. RMS current of only important layers of the cable in the conductor and shield

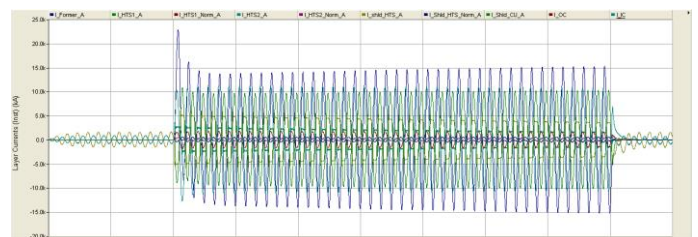

Fig. 10. Instantaneous current waveform of HTS cable in case of single line to ground fault of phase A

cable in the conductor and shield such as former, HTS conductor layer, shield HTS and shield stabilizer. As shown in this figure, the instantaneous load current of each HTS conductor layer is 0.84 kA, and the induced current in shield HTS is 1.57 kA. Fig. 9 shows RMS(root mean square) current in each layer. RMS current in shield HTS is 1.11 kArms, RMS current in each HTS conductor layer is 0.6 kArms.

Next, in this paper, fault current, temperature and resistance characteristics are described in each layer in case of single lint to ground fault, line to line to ground fault and three phases fault. The fault will be supposed to occur at load side of HTS cable.

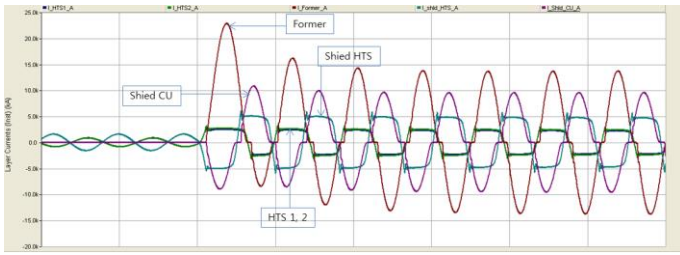

Fig. 11. Instantaneous current waveform of HTS cable important layer in case of single line to ground fault of phase A

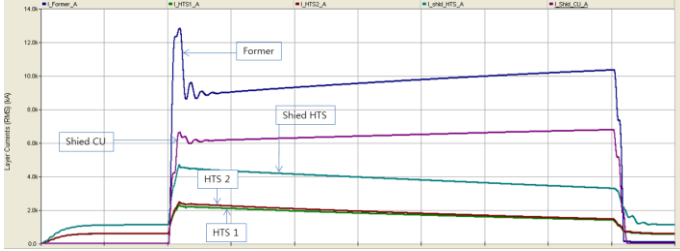

Fig. 12. RMS current waveform of HTS cable important layer in case of single line to ground fault of phase A

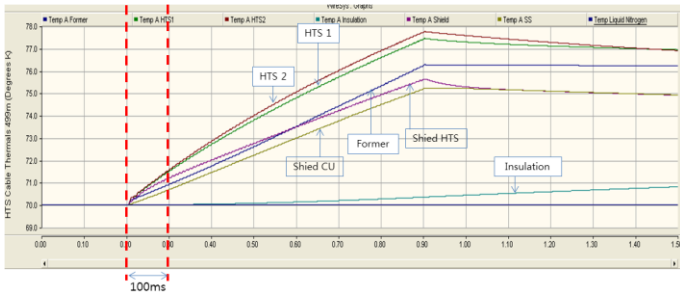

Fig. 13. HTS cable thermal impact of inlet side (499 m section)

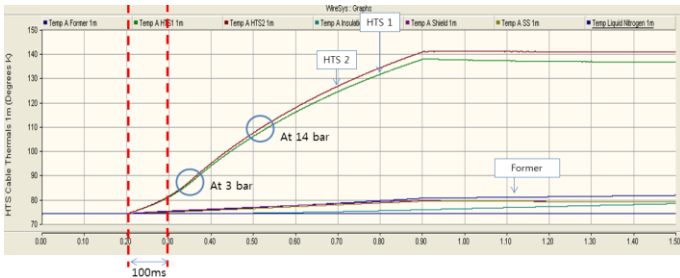
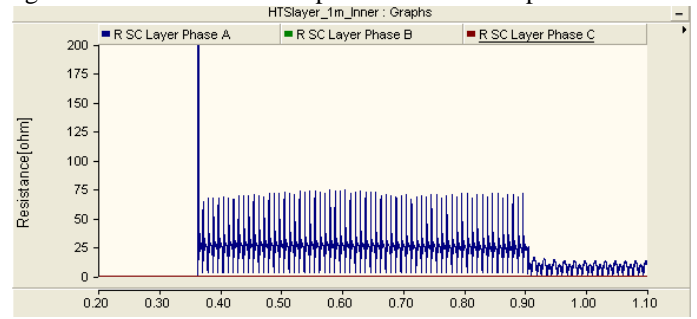

Fig. 14. HTS cable thermal impact of outlet side (1 m section)

Fig. 10 shows instantaneous current waveform occurred in phase A of HTS cable. As shown in this figure, 22 kA of fault current flows in former after the fault. Also, more current flows in the inner cryostat than the outer cryostat because the inner cryostat is at a much lower temperature and therefore has a much lower resistant. The current in inner cryostat is 11 kA, 9.8 kA of shield stabilizer, 5 kA of shield HTS 2.5 kA of each HTS conductor layer. Fig. 11 shows only important layers of former, HTS conductor layer, shield HTS and shield stabilizer. Fig. 12 is RMS fault current.

The temperature of each layer in HTS cable will be also described in this section in case of single line to ground fault. The total length of 500 m would be separated by 2 sections (499

m and 1 m) because the quench will be initially occurred at one small part and then it will spread along the length of the cable. Fig. 13 shows the thermal impact of the fault on phase A in inlet



(a)

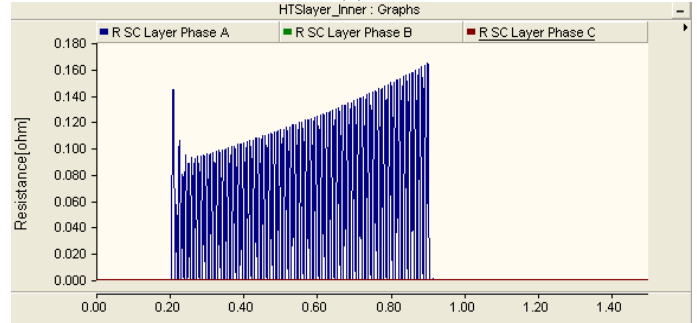

(b)

Fig. 15. HTS Resistance after single line to ground fault. (a) HTS Resistance in 1 m section. (b) HTS Resistance in 499 m section

side. It shows temperature rise in each layer of 499 m section. Fault duration supposed by 100 ms (approximately 6 cycle) considering fault clearing time by circuit breaker. HTS layers are most impacted by single line to ground fault and the peak temperature rise occurs in HTS 2 layer, followed by HTS 1 layer, former, shield HTS, shield stabilizer and insulation. The maximum temperature is 71.8 K after 100 ms. If the fault duration is supposed by 700 ms, it increased to 77.8 K. The initial temperature of inlet side is 70 K. Once the fault clears the heat in the various layers begins to slowly move from the hotter layers to the cooler layers. Especially, HTS layers begin to cool while the insulation and former layers began to warm as they absorb the heat from the adjacent HTS layers.

Fig. 14 shows the thermal impact of fault on phase A in outlet side of 1m section. As shown in this figure, the temperature of the HTS layers spikes to a much higher temperature than in the 499m section. The maximum temperature of HTS layer shows 81.5 K after 100 ms. HTS temperature increases to 140 K after 700 ms. The initial temperature of inlet side is 74 K. The HTS layer temperature exceeds 87.9 K at 3 bar which is designed by manufacturer in Korea. It causes a failure of the cable insulation system due to liquid nitrogen (LN₂) bubble formation. The temperature of HTS 2 layer exceeds the LN₂ bubble point approximately 150 ms (approximately 9 cycle) into the fault event. Therefore it would be strongly desirable that the fault be cleared prior to this time. In the case of operating at 14 bar which is designed in some installations, LN₂ will boil at 108 K, and the temperature of HTS layer exceeds the LN₂ bubble point after 300 ms (18 cycle)

Fig. 15 shows the HTS resistance after single line to ground fault in 1 m section and 499 m section. As shown in this figure, the HTS resistance in 1 m section is much higher than

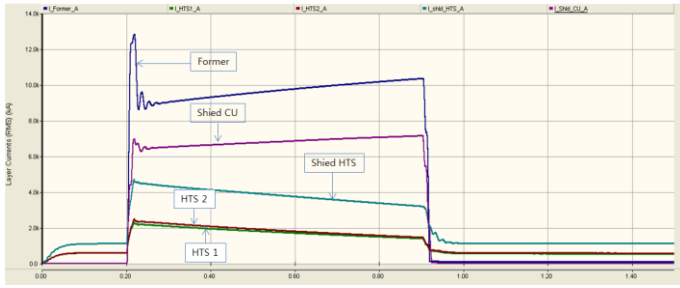

(a)

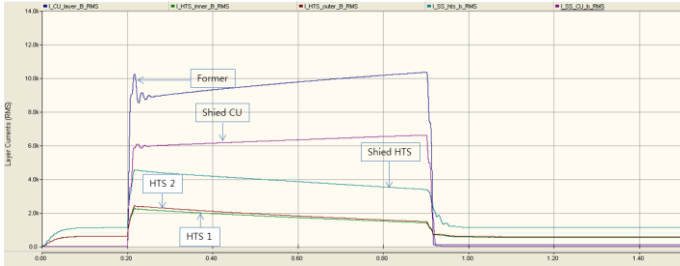

(b)

Fig. 16. RMS fault current in case of phase A to phase B to ground fault. (a) RMS fault current in phase A. (b) RMS fault current in phase B

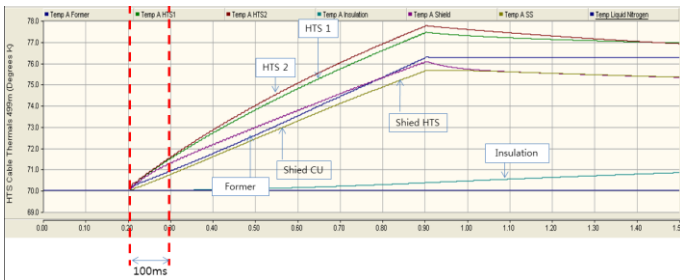

(a)

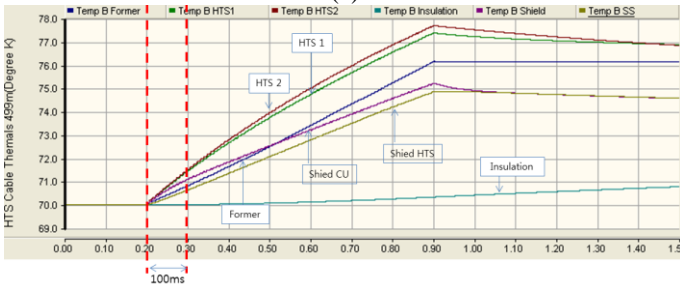

(b)

Fig. 17. HTS cable thermal impact in case of phase A to phase B to ground fault (499 m section). (a) HTS cable thermal impact of inlet side (499 m section of phase A). (b) HTS cable thermal impact of inlet side (499 m section of phase B).

499 m section.

This event will consider a bolted, line to line to ground fault on the load side of HTS cable. Fig. 16 shows RMS fault current of phase A and B in case of phase A to phase B to ground fault. The peak fault current of phase A in former is 12.8 kArms, it would be decreased some to 9.02 kArms after fault duration of 100 ms (6 cycle). RMS fault current in shield

stabilizer, shield HTS, HTS 1 layer and HTS 2 layer are 6.5 kArms, 4.32 kArms, 2.09 kArms and 2.23 kArms, respectively. In case of phase B, fault current in former, shield stabilizer,

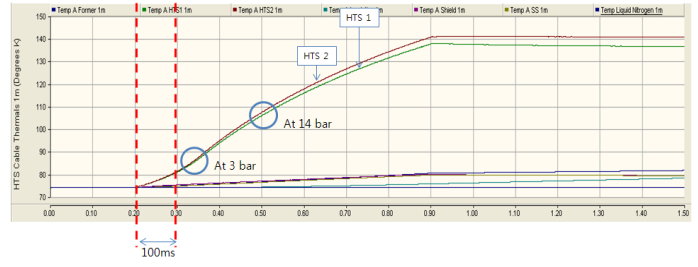

(a)

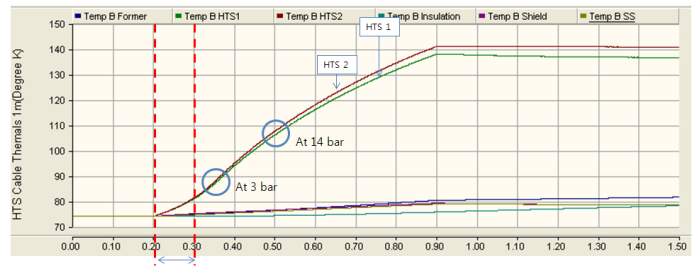

(b)

Fig. 18. HTS cable thermal impact in case of phase A to phase B to ground fault (1 m section). (a) HTS cable thermal impact of outlet side (1 m section of phase A). (b) HTS cable thermal impact of outlet side (1 m section of phase B).

shield HTS, HTS 1 layer and HTS 2 layer show 9.02 kArms, 6.02 kArms, 4.33 kArms, 2.08 kArms and 2.24 kArms after fault duration of 100 ms. It is very similar to fault current in phase A.

Fig. 17 shows that the HTS layers of 499 m section are most impacted by the line to line to ground fault and the peak temperature occurs in HTS 2 layer. The peak temperature is 71.6 K after fault duration of 100 ms and 77.7 K after fault duration of 700 ms. The initial temperature of inlet side is 70 K. Once the fault clears the heat in the various layers begins to slowly move from the hotter layers to the cooler layers. In this case, the HTS layer temperature does not exceed LN₂ bubble point of 87.9 K at 3 bar. The HTS cable thermal impact in Phase B is very similar to phase A. Once the fault clears the heat in the various layers begins to slowly move from the hotter layers to the cooler layers. Especially, the HTS layers begin to cool while the insulation and former layers began to warm as they absorb the heat from the adjacent HTS layers.

Fig. 18 shows the thermal impact of fault on phase A and B of 1 m section in case of phase A to phase B to ground fault. As shown in this figure, the temperature of the HTS layers spikes to a much higher temperature than in the 499 m section. The peak temperature in HTS 2 layer is 81.02 K after fault duration of 100 ms. The HTS layer temperature exceeds LN₂ bubble point at 3 bar after fault duration of 150 ms. If the cable pressure is supposed by 14 bar which is designed in some installations, the HTS layer temperature exceeds LN₂ bubble point after fault duration of 307 ms. The HTS cable thermal impact in Phase B is very similar to phase A.

V. CONCLUSIONS

This paper analyzed the medium voltage HTS thermal simulation using PSCAD/EMTDC. New simulation method and its applications are variously discussed in the normal operation condition as well as transient. The results are summarized as follows;

1) 3 phases HTS cable in one cryostat is modeled using PSCAD/EMTDC. HTS cable model has electrical model and thermal model. The electrical model is primarily responsible for calculating the resistance and power loss of each of the various layers of the HTS cable. The thermal model is responsible for calculating the temperature of each layer as a function of the power loss in each layer and the cable thermal characteristics

2) HTS cable will not quench uniformly along the length of the cable. One small part of the cable will initially quench and then the quenching will spread along the cable. Therefore, in this paper, both the electrical and thermal model was split in two cable sections in series with 1m cable and the other 499 m.

3) 22.9 kV HTS cable has been modeled using PSCAD/EMTDC. In normal operating condition, the instantaneous load current of each HTS conductor layer is 0.84 kA, and induced current in shield HTS is 1.57 kA. The shield HTS current are induced by the mutual coupling between conductor and the shield.

4) In the case of single line to ground fault, HTS layers are most impacted and the peak temperature rise occurs in HTS 2 layer followed by HTS 1 layer, former, shield HTS and shield stabilizer. The maximum temperature of 499 m section is 71.8 K after 100 ms and 77.8 K after 700 ms. The maximum temperature of 1m section is 81.5 K after 100 ms and 140 K after 700 ms. The temperature of 1 m section spikes to much higher than in the 499 m section, and the temperature of HTS 2

layer exceeds the LN₂ bubble point at 3 bar after 150 ms.

5) In the case of line to line ground fault, the peak temperature occurs in HTS 2 layer. The temperature of 499 m section is 71.6 K after fault duration of 100 ms and 77.7 K after fault duration of 700 ms. The maximum temperature of 1m section is 81.02 K after 100 ms and 140 K after 700 ms. The temperature of 1m section spikes to much higher than in the 499 m section, and the temperature of HTS 2 layer exceeds the LN₂ bubble point at 3 bar after 150 ms. The HTS layer temperature exceeds LN₂ bubble point after fault duration of 307 ms. The HTS cable thermal impact between phase A and Phase B is very similar.

REFERENCES

- [1] S. Lee, J. Yoon, B. Lee, B. Yang, "Modeling of a 22.9kV 50MVA superconducting power cable based on PSCAD/EMTDC for application to the Icheon Substation in Korea", *Physica C* 471(2011), Elsevier, May 2011
- [2] Minh-Chau Ding, C.H.Ju, J.G. Kim, M.W.Park, I.K.Yu and B.M.Yang, "Transient analysis of an HTS DC power cable with an HVDC system", *Physica C*(2013), Elsevier, April 2013
- [3] H. Lee, D. Yoon, S. Lee, B. Yang and G. Jang, "The insulation coordination and surge arrester design for HTS cable system in Icheon substation", *Physica C* 484(2013), Elsevier, April 2012
- [4] J. Yoon, S. Lee and B. Yang, "Optimal design specifications of 22.9kV HTS-FCL applied in real Korean power system", *IEEE Trans. On Applied Superconductivity*, Vol. 21, No. 3, June 2011
- [5] PSCAD/EMTDC Power system Simulation Software Manual, Manitoba HVDC Research Center, 1994